



**Pró-Hospitalar**  
Equipamentos Médicos Ltda

<b>NÚMERO NO MS</b> Conforme classes de risco	02
<b>A EMPRESA</b> Conheça a Pró-Hospitalar	03
<b>POLÍTICA DE QUALIDADE</b> Pilares e transparência	04
<b>CATÁLOGO</b> Lista de produtos	05
<b>ÍNDICE</b> Lista de referência dos produtos	182

## Número no Ministério da Saúde

ANDADOR DE TRAÇÃO	80061790042
ANACNC	80061790036
ASPIRADORES	80061790047
COXIM	80061790032
CADEIRA DE TRAÇÃO	80061790041
HALO VEST	80061790040
MAYFIELD	80061790009
INSTRUMENTAIS COM WIDIA	80061790045
INSTRUMENTAIS COM CONEXÃO	80061790033
INSTRUMENTAIS GERAIS	80061790048
INSTRUMENTAIS DE TITÂNIO	80061790044
MARTELOS	80061790046
MARTELO POLIACETAL	80061790002
PINÇAS BIPOLARES	80061790039

## A EMPRESA

Atuando no mercado desde 1988, a Pró-Hospitalar Equipamentos Médicos dedica-se com eficiência à industrialização e comercialização de instrumentos médicos, cirúrgicos e hospitalares. Qualidade é um compromisso real da nossa empresa.

## MISSÃO

Fornecer instrumentais cirúrgicos da mais alta qualidade do Brasil.

## VISÃO

Atender às necessidades de cada cliente de forma satisfatória e conquistar a liderança nacional até 2025.

## VALORES

- \* Qualidade em tudo que faz;
- \* Pessoas comprometidas e realizadas;
- \* Cliente satisfeito;
- \* Gestão participativa;
- \* Diversidade;
- \* Relacionamentos abertos e honestos por meio da comunicação.



**Pró-Hospitalar**  
Equipamentos Médicos Ltda



## POLÍTICA DE QUALIDADE

Nosso sistema da qualidade está fundamentado:

- Na Satisfação de nossos clientes e parceiros;
- Na Comunidade e ambiente onde estamos inseridos;
- No Respeito ao meio ambiente e à sustentabilidade;
- Na Formação contínua de nossos colaboradores.

## SUSTENTADA PELOS SEGUINTE PILARES:

- Qualidade total dos nossos produtos e serviços.
- Melhoria contínua dos processos.
- Amparo total na legislação.
- Infraestrutura adequada e humanizada.
- Treinamento e reciclagens constantes.

## TRANSPARÊNCIA

A Pró-Hospitalar é líder no mercado nacional atendendo diversos hospitais, médicos, clínicas e empresas em geral. Fidelidade e comprometimento na fabricação dos produtos são atitudes que valorizamos.

A empresa investe em tecnologia e atualiza produtos e serviços para oferecer aos seus clientes a melhor solução em instrumentais cirúrgicos.





**Pró-Hospitalar**  
Equipamentos Médicos Ltda

# NOSSOS PRODUTOS

Consulte também nosso catálogo on-line  
[www.prohospitalar.com.br](http://www.prohospitalar.com.br)

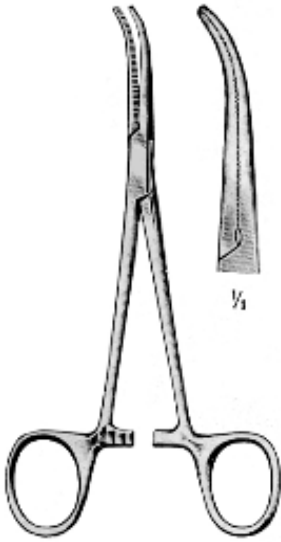

Pinça de Dandy  
para couro cabeludo  
14,0cm  
PH-01.1802

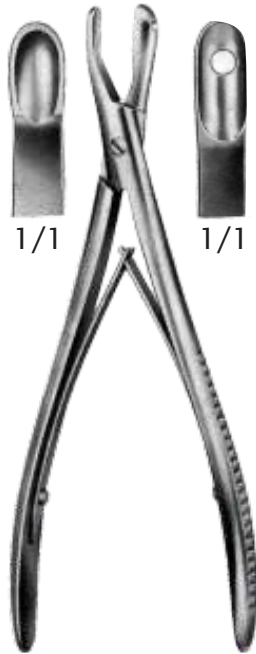

Pinça Adson  
protetora de duramater  
20,0cm  
PH-01.1801  
15,0cm  
PH-23.6240

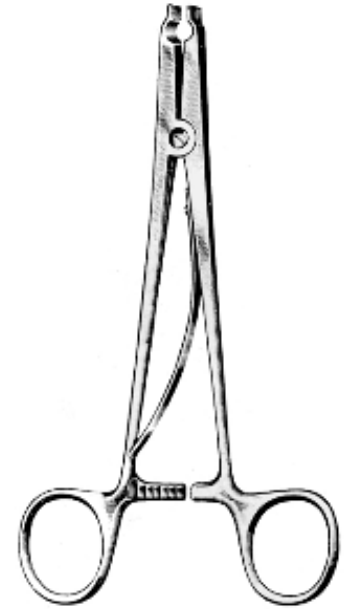

Aplicador de clip de Raney  
metálico  
PH-01.1790

Scalp para couro  
cabeludo e Hemostasia



Agrafe de Michael  
pacote com  
100 unidades



Clip de Raney  
metálico      descartável  
PH-01.1795    PH-01.1796



Clip de Colônia  
metálico  
PH-01.1800

Referência	Comprimento x Tamanho
PH-01.1403	 14x3mm
PH-01.1603	 16x3mm
PH-01.1803	 18x3mm
PH-01.2003	 20x3mm
PH-01.2203	 22x3mm



Gancho com mola Yasargil para fixação de galea

pequeno  
PH-01.1903

grande  
PH-01.1904

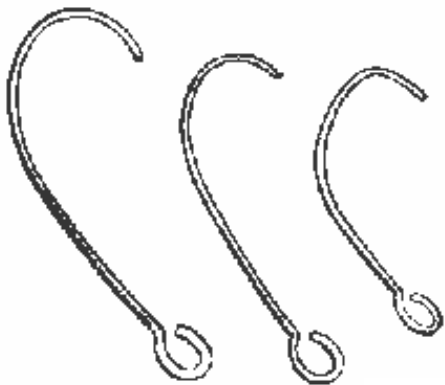

Gancho escalpo  
Fukushima

pequeno  
PH-01.1905

médio  
PH-01.1906

grande  
PH-01.1907

Gancho com mola

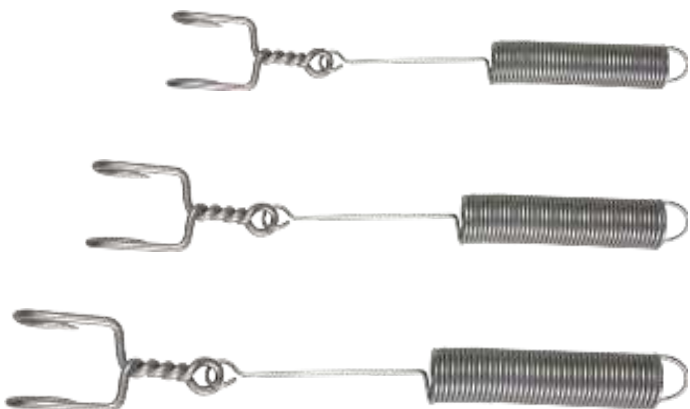

pequeno  
PH-01.1900

médio  
PH-01.1901

grande  
PH-01.1902





Alicate Bernardão  
para cortes de barras e fios  
até  $\varnothing$  6,0mm com Widia

PH-14.0014 30cm

PH-01.0047 47cm

PH-01.0060 60mm



Cortador de fios  $\varnothing$  4,0/5,0/5,5/6,0mm  
560mm fechado  
710mm aberto

PH-01.0040



Alicate com wídia  
para corte de fio de  
aço 0,0 a 3,0mm

PH-01.0025



Alicate com wídia  
18,0cm para corte de  
fio de aço 0,0 a 2,0mm

PH-01.0026



Alicate com wídia  
para corte de fio de  
aço 0,0 a 2,0mm

PH-01.0027



Alicate universal com corte  
22cm  
PH-01.0028



Alicate de pressão  
em aço inox  
18cm  
PH-01.0029  
20cm  
PH-01.0030

## Afastadores / Retratores Auto-Retensão Hemilaminectomia / Laminectomia



Beckman Adson 4x4 dentes cegos  
31cm

Profundidade

25x25mm

PH-01.2525

25x32mm

PH-01.2532

25x44mm

PH-01.2544



Beckman Eaton 7x7 dentes afiados  
32,4cm

afiado  
PH-01.1030  
cego  
PH-01.1031



Cone 3x4 dentes  
Afiados

16,2cm  
PH-01.0162  
20,3cm  
PH-01.0203



Adson 5x6 dentes

afiados  
24cm  
PH-01.2436  
27cm  
PH-01.2738

cegos  
24cm  
PH-01.2437  
27cm  
PH-01.2739



Adson modificado  
27cm

afiado  
PH-01.1048  
cego  
PH-01.1049



Adson curvo 3x4 dentes  
27cm

afiado  
PH-01.1019

cego  
PH-01.1021



Adson reto 4x4 dentes

afiados  
18cm  
PH-01.1011  
20cm  
PH-01.1000

cegos  
18cm  
PH-01.1012  
20cm  
PH-01.1001

## Afastadores / Retratores Auto-Estáticos / Auto-Retenção



H-01.103P



3x4 Dentes  
afiado  
PH-01.1035  
cego



Beckman  
31 cm

5x6 Dentes  
afiado  
PH-01.1036  
cego  
PH-01.1038



Beckmann 4x4 Dentes  
20cm  
afiado  
PH-01.1044  
cego  
PH-01.1045



Beckmann 4x4 Dentes  
30,5cm  
afiado  
PH-01.1040  
cego  
PH-01.1041

## Afastadores / Retratores Auto-Estáticos / Auto-Retenção



Anderson Adson

20cm

4x4 dentes

afiado

PH-01.1020

cego

PH-01.1203

5x5 dentes

afiado

PH-01.1022

cego

PH-01.1205

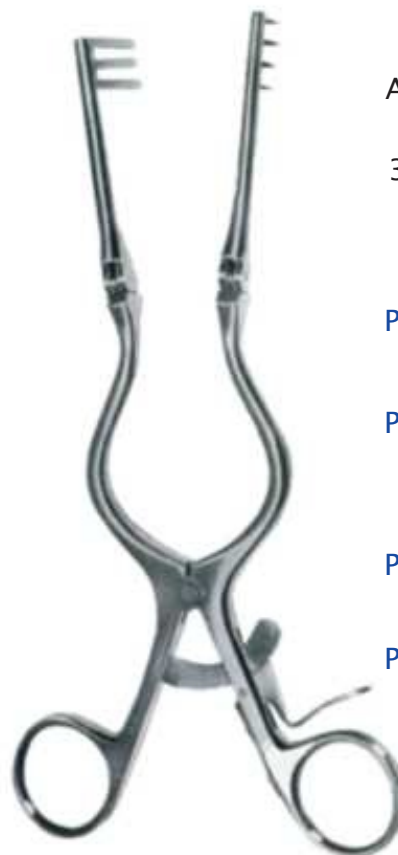

Adson Baby longo

3x4 dentes

afiado

20cm

PH-02.1020

26cm

PH-02.1026

cego

20cm

PH-02.1200

26cm

PH-02.1126



Adson

3x4 dentes curto

afiado

14cm

PH-02.1090

16cm

PH-02.1100

cego

14cm

PH-02.1091

16cm

PH-02.1101



Weitlaner

3x4 dentes reto

afiado

13cm

PH-02.1042

16,5cm

PH-02.1051

cego

13cm

PH-02.1043

16,5cm

PH-02.1052

## Afastadores / Retratores Auto-Estáticos / Auto-Retenção



Weitlaner 2x3 dentes  
reto

afiado

10,5cm

PH-02.1040

14cm

PH-02.1041

16,5cm

PH-02.1050

cego

10,5cm

PH-02.1045

14cm

PH-02.1046

16,5cm

PH-02.1055



Weitlaner 3x3 dentes  
meio curvo

afiado

13cm

PH-02.1044

16,5cm

PH-02.1047

cego

13cm

PH-02.1048

16,5cm

PH-02.1049



3x4 dentes

afiado

20cm

PH-02.1111

25cm

PH-02.1120

cego

20cm

PH-02.1112

25cm

PH-02.1121



5x6 dentes

afiado

25cm

PH-02.1122

cego

25cm

PH-02.1123



Afastadores / Retratores Auto-estático  
Auto-Retenção / Retrator de Mão



Caspar  
25cm



Gelpi Loktite com anel de proteção  
18cm  
PH-04.1270



Gelpi Perineal  
18cm  
PH-04.1275



Gelpi Poppen  
14cm  
PH-04.1280



Gelpi-Seiletz  
15cm  
PH-04.1285



Direito



Esquerdo

Markham-Meyerdung abertura 95mm  
17,8cm

Lâmina 25x51mm direito

PH-03.2551

Lâmina 25x51mm esquerdo

PH-03.2552

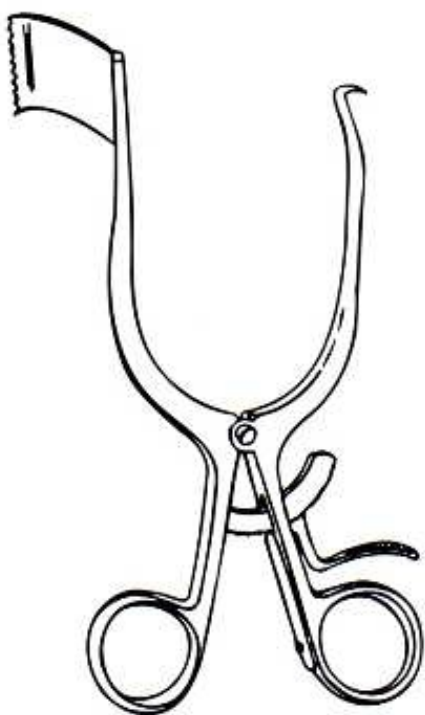

Williams  
esquerdo

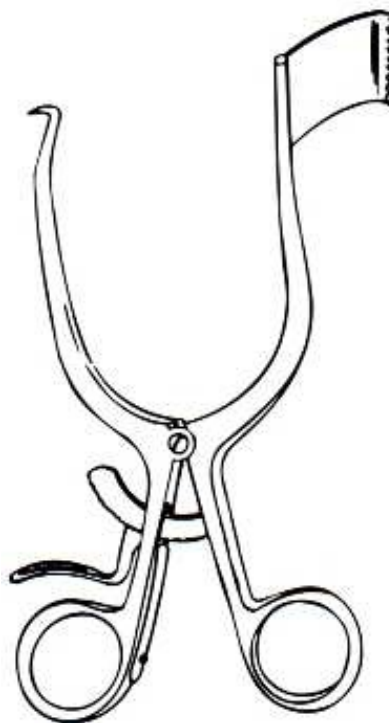

Williams  
direito

direito  
50x10mm  
PH-03.5010  
60x10mm  
PH-03.6010  
70x10mm  
PH-03.7010

esquerdo  
50x10mm  
PH-04.5010  
60x10mm  
PH-04.6010  
70x10mm  
PH-04.7010

direito  
50x20mm  
PH-03.5020  
60x20mm  
PH-03.6020  
70x20mm  
PH-03.7020

esquerdo  
50x20mm  
PH-04.5020  
60x20mm  
PH-04.6020  
70x20mm  
PH-04.7020

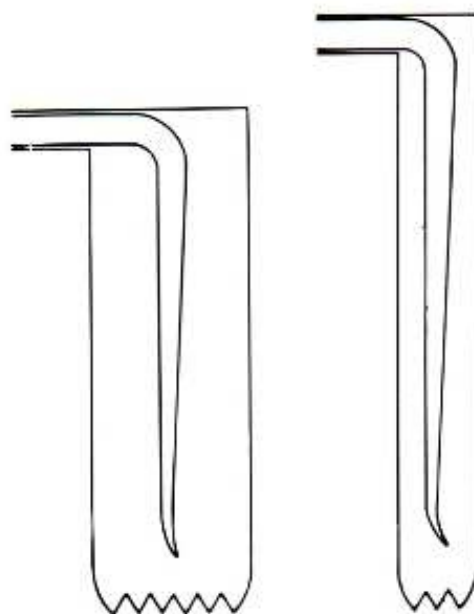

Lâmina 20mm

Lâmina 10mm



Jansen Mastoide 3x3 dentes  
abertura total 44mm  
10,2cm  
afiado  
PH-04.1240  
cego  
PH-04.1235



Jansen Schnitman 3x3 dentes  
abertura total 51mm  
10,6cm  
afiado  
PH-04.1239  
cego  
PH-04.1238



Jansen Scalp 4x4 dentes  
abertura total 76mm  
11,7cm  
afiado  
PH-04.1237  
cego  
PH-04.1236



Alm  
afiado  
70mm  
PH-04.1255  
100mm  
PH-04.1265  
cego  
70mm  
PH-04.1256  
100mm  
PH-04.1266



Meyerding  
abertura 9,5cm  
16,5cm  
Lâmina 25x41mm  
PH-04.2541  
Lâmina 25x51mm  
PH-04.2551  
Lâmina 25x57mm  
PH-04.2557

## Afastadores / Retratores Auto-Estático Auto-Retenção Coluna Lombar e Torácica



Gelpi Longo com garra 4x4 dentes, Retenção  
com Parafuso ou Cremalheira  
240mm

Afiados			Cegos		
Código	Angulo	Medida Gancho	Código	Angulo	Medida Gancho
PH-04.1297	60°	60mm	PH-04.1298	60°	60mm
PH-04.1305	60°	70mm	PH-04.1306	60°	70mm
PH-04.1313	60°	80mm	PH-04.1314	60°	80mm
PH-04.1321	60°	90mm	PH-04.1322	60°	90mm
PH-04.1299	90°	60mm	PH-04.1300	90°	60mm
PH-04.1307	90°	70mm	PH-04.1308	90°	70mm
PH-04.1315	90°	80mm	PH-04.1316	90°	80mm
PH-04.1323	90°	90mm	PH-04.1324	90°	90mm

Gelpi Extra-Longo com garra 4x4 dentes, Retenção  
com Parafuso ou Cremalheira  
290mm

Afiados			Cegos		
Código	Angulo	Medida Gancho	Código	Angulo	Medida Gancho
PH-04.1317	60°	60mm	PH-04.1318	60°	60mm
PH-04.1309	60°	70mm	PH-04.1310	60°	70mm
PH-04.1301	60°	80mm	PH-04.1302	60°	80mm
PH-04.1325	60°	90mm	PH-04.1326	60°	90mm
PH-04.1319	90°	60mm	PH-04.1320	90°	60mm
PH-04.1311	90°	70mm	PH-04.1312	90°	70mm
PH-04.1303	90°	80mm	PH-04.1304	90°	80mm
PH-04.1327	90°	90mm	PH-04.1328	90°	90mm

## Afastadores / Retratores Auto-Estático Auto-Retensão Coluna Lombar e Torácica



Angulado

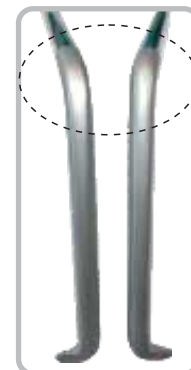

Gelpi extra-longo com gancho, retenção com parafuso ou cremalheira

24,0cm

29,0cm

Código	Angulo	Medida Gancho	Código	Angulo	Medida Gancho
PH-04.1290	60°	60mm	PH-04.1282	60°	60mm
PH-04.1274	60°	70mm	PH-04.1277	60°	70mm
PH-04.1279	60°	80mm	PH-04.1295	60°	80mm
PH-04.1284	60°	90mm	PH-04.1287	60°	90mm
PH-04.1291	90°	60mm	PH-04.1283	90°	60mm
PH-04.1276	90°	70mm	PH-04.1278	90°	70mm
PH-04.1281	90°	80mm	PH-04.1296	90°	80mm
PH-04.1286	90°	90mm	PH-04.1288	90°	90mm

Parafuso



Cremalheira



## Afastadores / Retratores Auto-Estático Auto-Retenção Coluna Lombar e Torácica



Encaixe rápido



Gelpi modificado com  
lâminas e gancho  
20,5cm

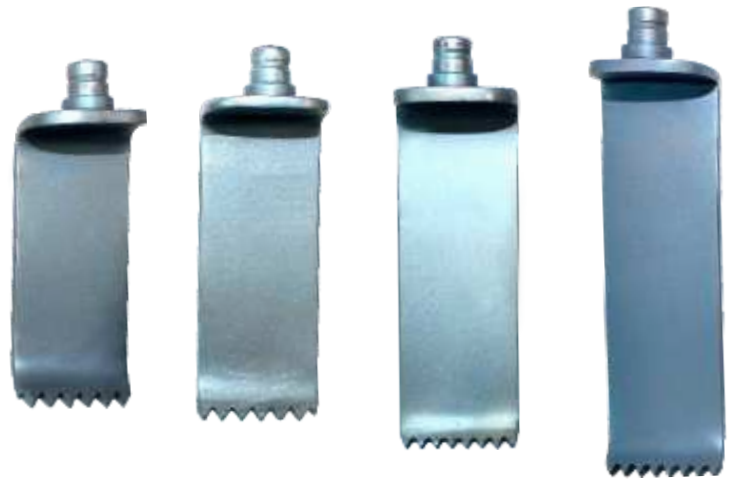

25x55mm

25x60mm

25x70mm

25x80mm

Kit afastador	Gancho	Lâmina
PH-07.1245	45mm	25x55mm
PH-07.1250	50mm	25x60mm
PH-07.1260	60mm	25x70mm
PH-07.1270	70mm	25x80mm

Cada kit corresponde a um tamanho de gancho e um tamanho de lâmina.

Venda lâminas avulsas	
PH-07.1255	25x55mm
PH-07.1247	25x60mm
PH-07.1248	25x70mm
PH-07.1280	25x80mm



Ejetor de lâminas  
PH-07.1254

Ejetor de lâminas acompanha o kit

## Afastadores / Retratores Auto-Estático Auto-Retensão Coluna Lombar e Torácica



25x55mm

25x60mm

25x70mm

25x80mm

Kit afastador	Gancho	Lâmina
PH-07.1246	45mm	25x55mm
PH-07.1251	50mm	25x60mm
PH-07.1261	60mm	25x70mm
PH-07.1271	70mm	25x80mm

Cada kit corresponde a um tamanho de gancho e um tamanho de lâmina.

Knighton modificado  
com lâmina, gancho  
e sistema de cremalheira  
19cm



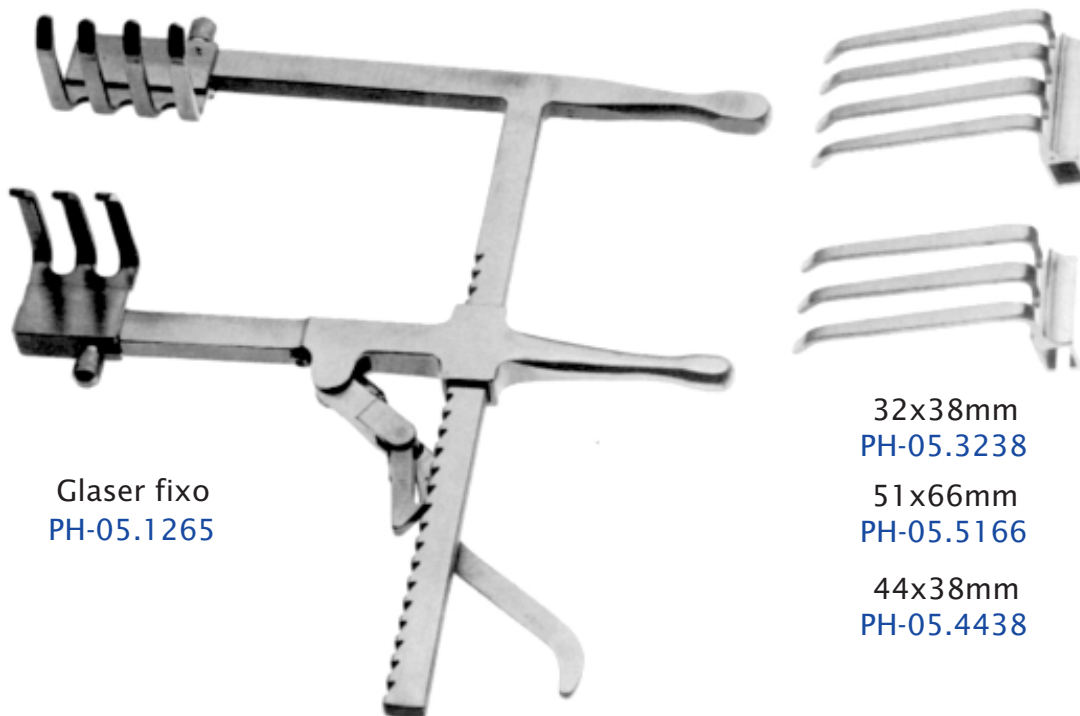

Glaser fixo  
PH-05.1265

32x38mm  
PH-05.3238

51x66mm  
PH-05.5166

44x38mm  
PH-05.4438

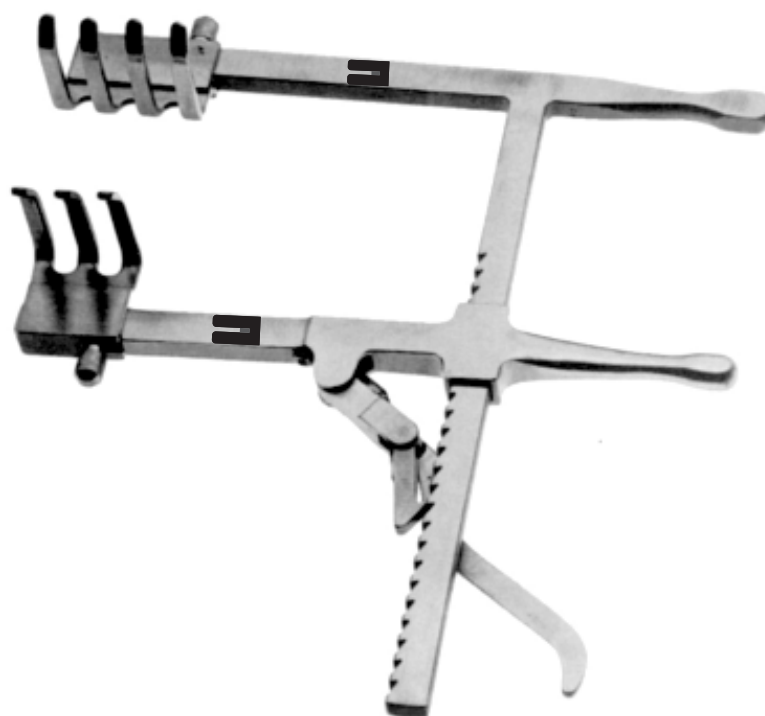

Glaser articulado  
PH-05.1266

## Kit

Abertura total ( 11,4cm )  
03 Lâminas (01 pequena, 01 média, 01 grande)

## Afastadores / Retratores de Mão de tecidos moles e raízes nervosas

Largura x Comprimento

3mmx70mm    3mmx100mm

PH-05.7003    PH-05.1003

5mmx70mm    5mmx100mm

PH-05.7005    PH-05.1005

7mmx70mm    7mmx100mm

PH-05.7007    PH-05.1007

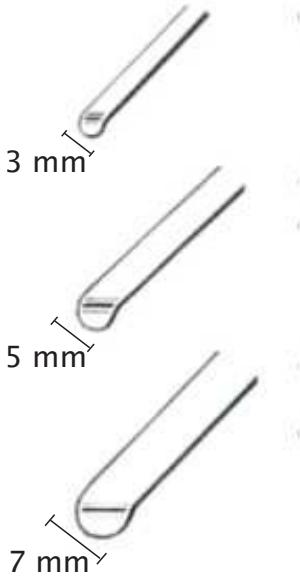

Love 210mm



Scoville reto  
23cm

PH-05.2307



Scoville meio angulado  
23cm

PH-05.2407



Scoville angulado  
23cm

PH-05.2507

## Afastadores / Retratores de Mão de tecidos moles e raízes nervosas



Army Naves  
11,4cm

Lâminas  
18mm  
PH-05.1118  
20mm  
PH-05.1120  
23mm  
PH-05.1123



Cushing  
19,7cm

Lâminas  
9,5x6,4mm  
PH-05.9564



Cushing  
24cm

10mm  
PH-24.1001  
12mm  
PH-24.1002  
14mm  
PH-24.1004  
16mm  
PH-24.1006

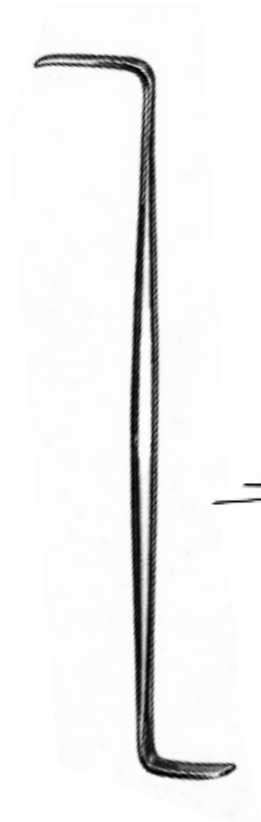

Davis  
14cm

19mm  
6mm  
PH-06.0176  
22mm  
8mm  
PH-06.0177



Holscher  
22cm

6mm  
13mm  
estreito 6mm  
PH-05.2206  
largo 13mm  
PH-05.2213

## Afastadores / Retratores de Mão de tecidos moles e raízes nervosas



Langenbeck-Green  
16cm



PH-06.1600



PH-06.1601



PH-06.1603



11x13mm  
PH-06.1602



16x6mm  
PH-06.1604



25x6mm  
PH-06.1605



Senn-Muller  
16cm

afiado  
PH-06.1391



cego  
PH-06.1392



Senn-Green  
15cm



10x6mm  
PH-06.1006



20x6mm  
PH-06.1061



Gil-Vernet  
24cm

17mm  
PH-06.2417

20mm  
PH-06.2420



Senn-Muller Baby  
16cm



afiado  
PH-06.1390



cego  
PH-06.1395

Afastador Taylor com  
cabo e lâmina  
longitudinal

25x76mm

PH-05.2576

25x102mm

PH-05.2502

32x76mm

PH-05.3276

32x102mm

PH-05.3102

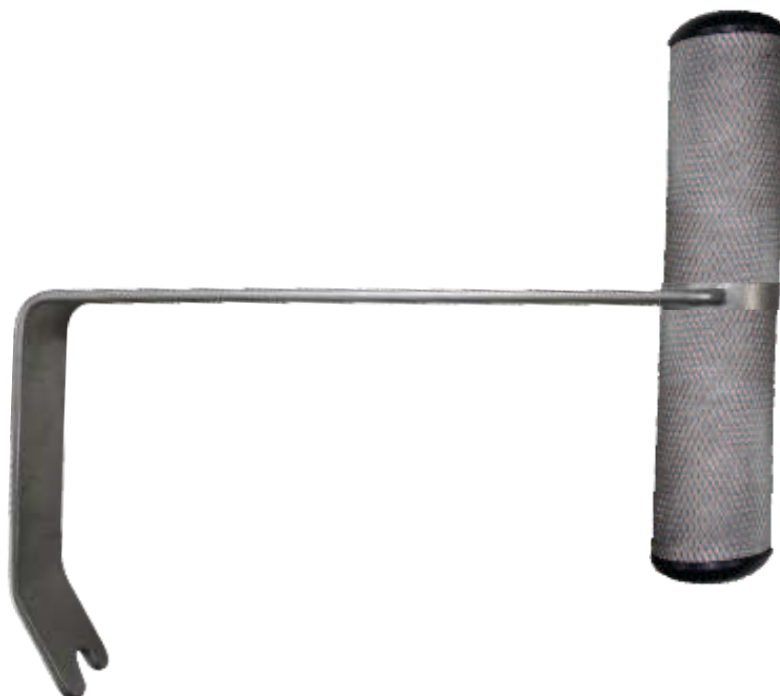

Comprimento do cabo até a curva da haste 184mm



Afastador Taylor com  
cabo e lâmina medial

25x76mm

PH-06.2577

25x102mm

PH-06.2503

32x76mm

PH-06.3277

32x102mm

PH-06.3103

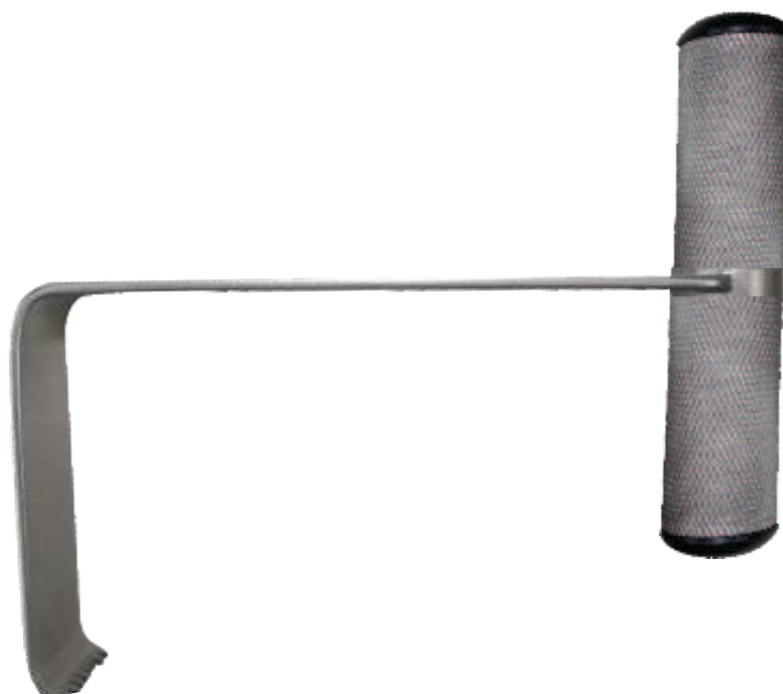

## Afastadores / Retratores Espinhal Retratores de Mão



Taylor  
18,4cm

15x90mm  
PH-06.1590  
20x90mm  
PH-06.2900  
25x76mm  
PH-06.2576  
25x102mm  
PH-06.2502  
30x76mm  
PH-06.3076  
32x76mm  
PH-06.3276  
32x102mm  
PH-06.3202  
40x76mm  
PH-06.4076

40x90mm  
PH-06.4090  
40x102mm  
PH-06.4002  
40x120mm  
PH-06.4020  
60x76mm  
PH-06.6076  
60x90mm  
PH-06.6090  
60x102mm  
PH-06.6010  
60x120mm  
PH-06.6020



Hibbs  
22cm  
25x75mm  
PH-06.2575  
24cm  
25x80mm  
PH-06.2580



Meyerding  
20cm  
50x16mm  
PH-06.1315  
220mm  
75x25mm  
PH-06.1320  
240mm  
90x50mm  
PH-06.1325

Farabeuf  
12cm  
PH-06.1201



Farabeuf  
15cm  
PH-06.1501



Farabeuf  
Baby  
7x100mm  
PH-06.1008

Infantil  
10x120mm  
PH-06.1009

Adulto  
13x125mm  
PH-06.1010

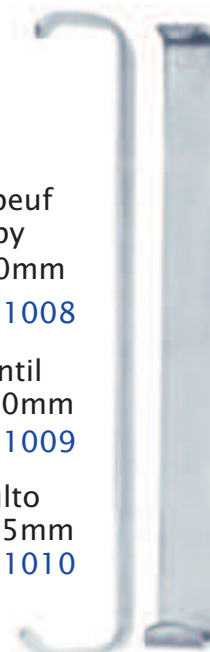

## Afastador / Retrator de Mão

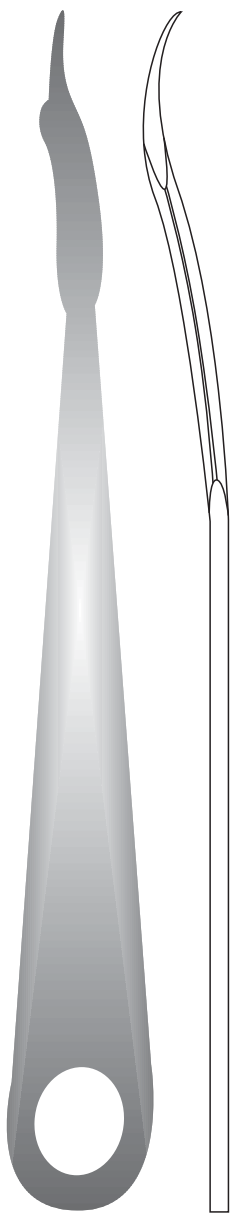

Afastador Hohmann 22cm  
lâmina 8mm ponta fina

**PH-06.0822**

Afastador Hohmann curvo  
22cm lâmina 8mm ponta fina

**PH-06.0823**

Afastador Hohmann meio curvo  
22cm lâmina 8mm ponta fina

**PH-06.0824**



Afastador Hohmann 22cm  
lâmina 18mm ponta fina

**PH-06.1822**

Afastador Hohmann curvo  
22cm lâmina 18mm ponta fina

**PH-06.1823**

Afastador Hohmann meio curvo  
22cm lâmina 18mm ponta fina

**PH-06.1824**

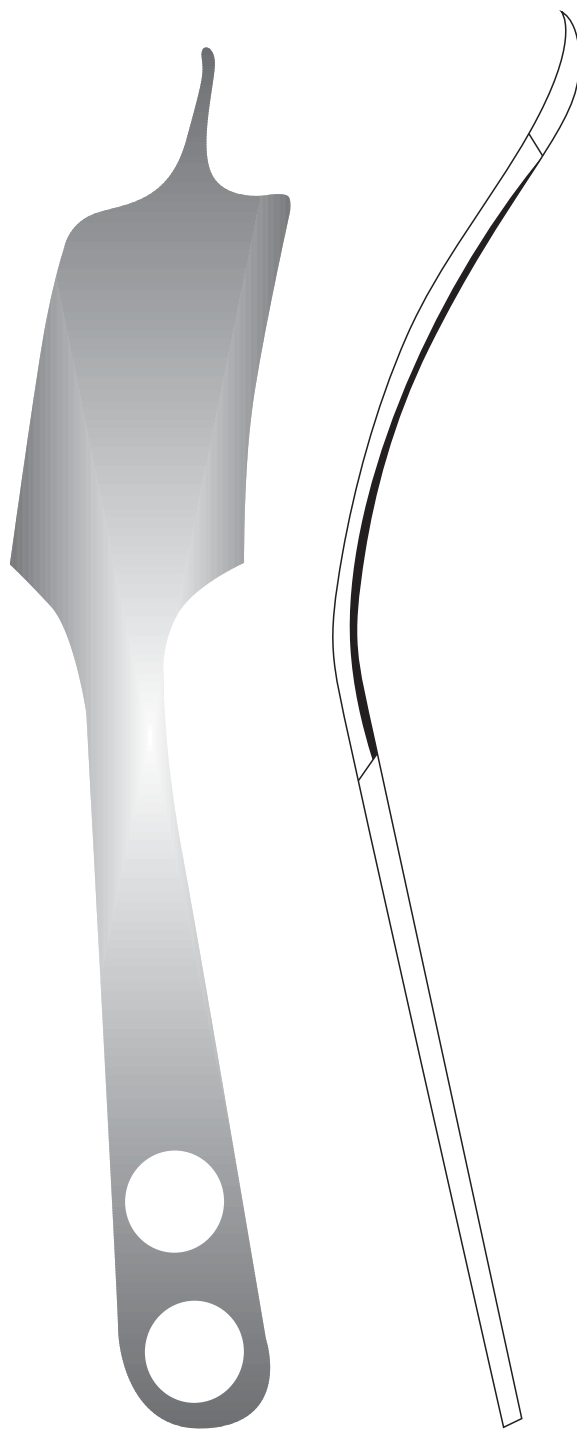

Afastador Hohmann 25cm  
lâmina 43mm ponta fina

**PH-06.4325**

Afastador Hohmann curvo  
25cm lâmina 43mm ponta fina

**PH-06.4326**

Afastador Hohmann meio curvo  
25cm lâmina 43mm ponta fina

**PH-06.4327**



Langenbeck  
25cm

### Largura x Comprimento da lâmina

10x30mm PH-06.1030	15x30mm PH-06.1530	20x30mm PH-06.2030	25x30mm PH-06.2530
10x35mm PH-06.1035	15x35mm PH-06.1535	20x35mm PH-06.2035	25x35mm PH-06.2535
10x40mm PH-06.1040	15x40mm PH-06.1540	20x40mm PH-06.2040	25x40mm PH-06.2540
10x45mm PH-06.1045	15x45mm PH-06.1545	20x45mm PH-06.2045	25x45mm PH-06.2545
10x50mm PH-06.1050	15x50mm PH-06.1550	20x50mm PH-06.2050	25x50mm PH-06.2550
10x55mm PH-06.1055	15x55mm PH-06.1555	20x55mm PH-06.2055	25x55mm PH-06.2555
10x60mm PH-06.1060	15x60mm PH-06.1560	20x60mm PH-06.2060	25x60mm PH-06.2560
10x70mm PH-06.1070	15x70mm PH-06.1570	20x70mm PH-06.2070	25x70mm PH-06.2570
30x30mm PH-06.3030	35x30mm PH-06.3530	40x30mm PH-06.4030	45x30mm PH-06.4530
30x35mm PH-06.3035	35x35mm PH-06.3535	40x35mm PH-06.4035	45x35mm PH-06.4535
30x40mm PH-06.3040	35x40mm PH-06.3540	40x40mm PH-06.4040	45x40mm PH-06.4540
30x45mm PH-06.3045	35x45mm PH-06.3545	40x45mm PH-06.4045	45x45mm PH-06.4545
30x50mm PH-06.3050	35x50mm PH-06.3550	40x50mm PH-06.4050	45x50mm PH-06.4550
30x55mm PH-06.3055	35x55mm PH-06.3555	40x55mm PH-06.4055	45x55mm PH-06.4555
30x60mm PH-06.3060	35x60mm PH-06.3560	40x60mm PH-06.4060	45x60mm PH-06.4560
30x70mm PH-06.3070	35x70mm PH-06.3570	40x70mm PH-06.4070	45x70mm PH-06.4570



## Afastador/Retrator para Via de Acesso Torácico Anterior

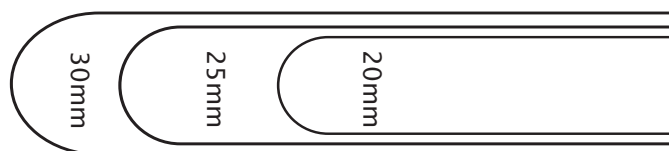
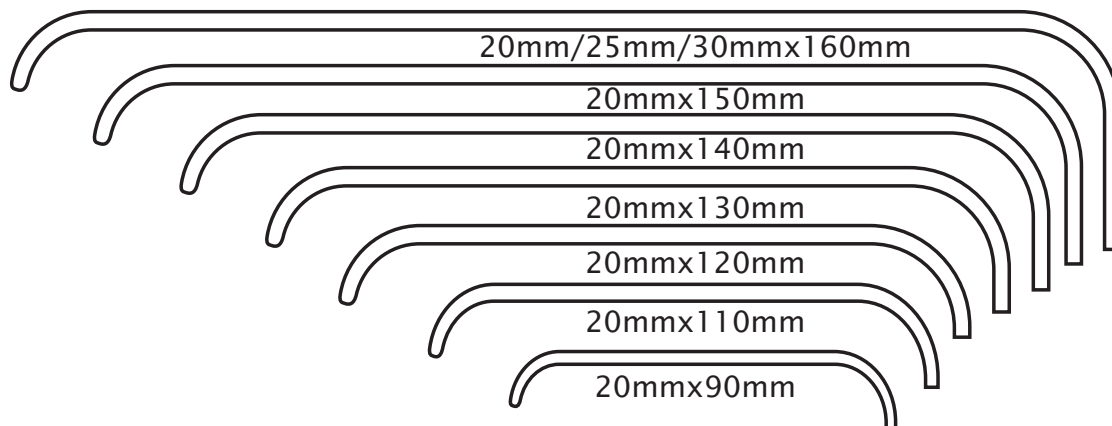

Langenbeck  
25cm

estreito	médio	largo
20mmx90mm PH-06.2090	25mmx100mm PH-06.2510	30mmx100mm PH-06.3010
20mmx110mm PH-06.2011	25mmx120mm PH-06.2520	30mmx120mm PH-06.3012
20mmx130mm PH-06.2013	25mmx140mm PH-06.2514	30mmx140mm PH-06.3014
20mmx150mm PH-06.2015	25mmx160mm PH-06.2516	30mmx160mm PH-06.3016



## Afastadores / Retratores Auto-Retenção / Hemilaminectomia



Afastador  
downing com cremalheira  
incluindo 03 ganchos e 03 lâminas  
PH-07.2000



Ganchos  
38mm  
PH-07.0138  
51mm  
PH-07.0651  
76mm  
PH-07.0751



Lâminas  
51x38mm  
PH-07.5138  
64x51mm  
PH-07.6451  
76x51mm  
PH-07.7651

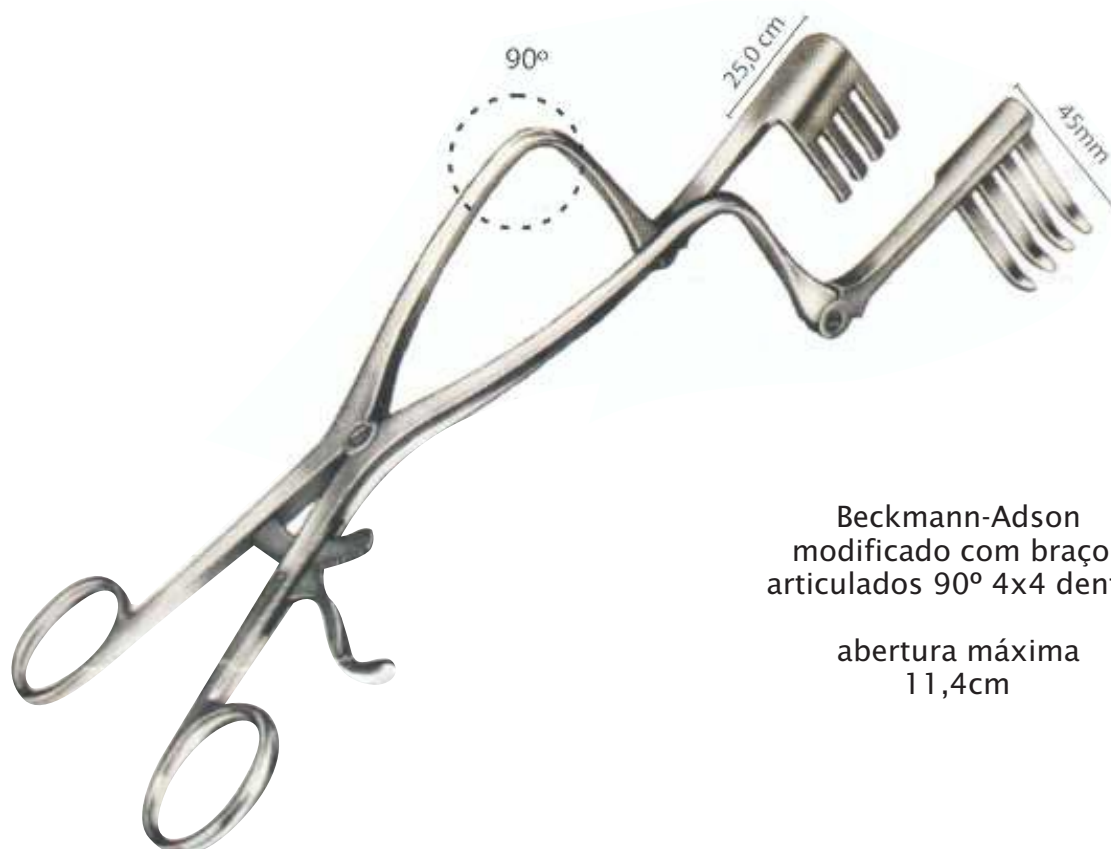

Beckmann-Adson  
modificado com braços  
articulados 90° 4x4 dentes

abertura máxima  
11,4cm

afiado  
PH-07.4525

cego  
PH-07.4526

## Afastadores / Retratores Auto-Retenção Hemilaminectomia

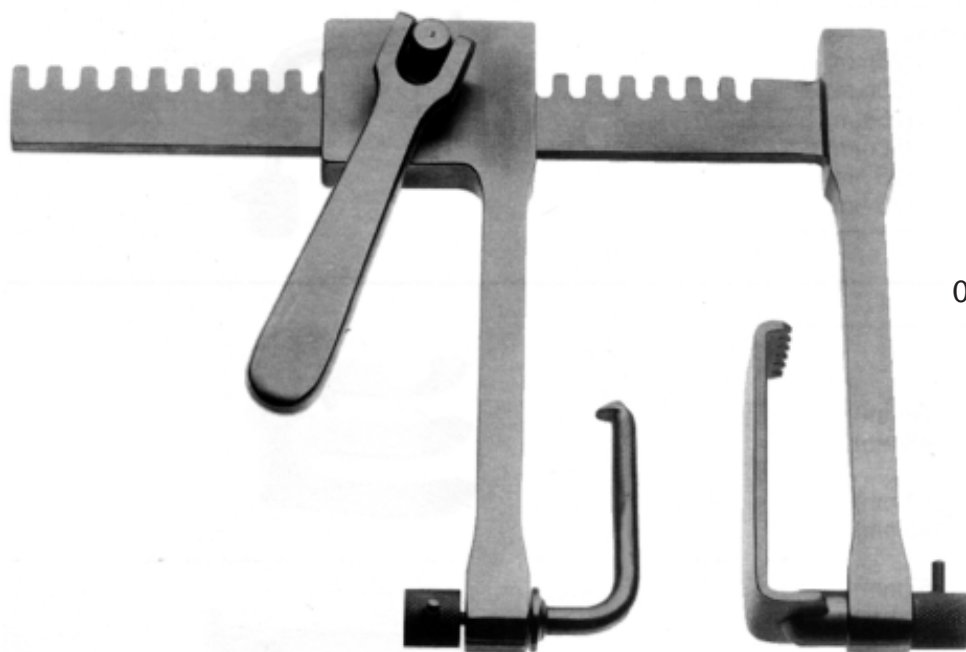

Valin  
abertura total 11,4cm  
01 gancho 51mm  
01 lâmina de 25mmx64mm  
[PH-07.1400](#)



Scoville com  
Cremalheira  
01 Gancho  
01 Lâmina  
[PH-07.1510](#)



Lâmina  
25x51 mm  
[PH-07.2551](#)  
51x89mm  
[PH-07.5189](#)  
25x82mm  
[PH-07.2582](#)

As lâminas e ganchos são intercambiáveis e opcionais para uso no chassi dos afastadores.

## Afastadores / Retratores Auto-Retenção Hemilaminectomia



Scoville-Haverfield  
braços articulados  
abertura máxima  
17,8cm  
PH-07.1530

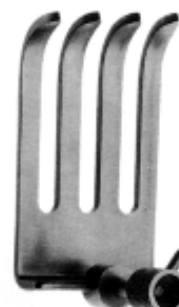

Lâminas opcionais  
4 Pinos

29x67mm  
PH-07.2967

25x89mm  
PH-07.2589

38x41mm  
PH-07.3841

44x67mm  
PH-07.4467



Lâmina Scoville

25x64mm  
PH-07.2564



Ganchos Scoville para  
hemilaminectomia  
profundidade

38mm  
PH-07.1538

51mm  
PH-07.1551

70mm  
PH-07.1570

76mm  
PH-07.1576

As lâminas e ganchos são intercambiáveis e opcionais para uso no chassi dos afastadores.

## Afastadores / Retratores Auto-Retenção Hemilaminectomia

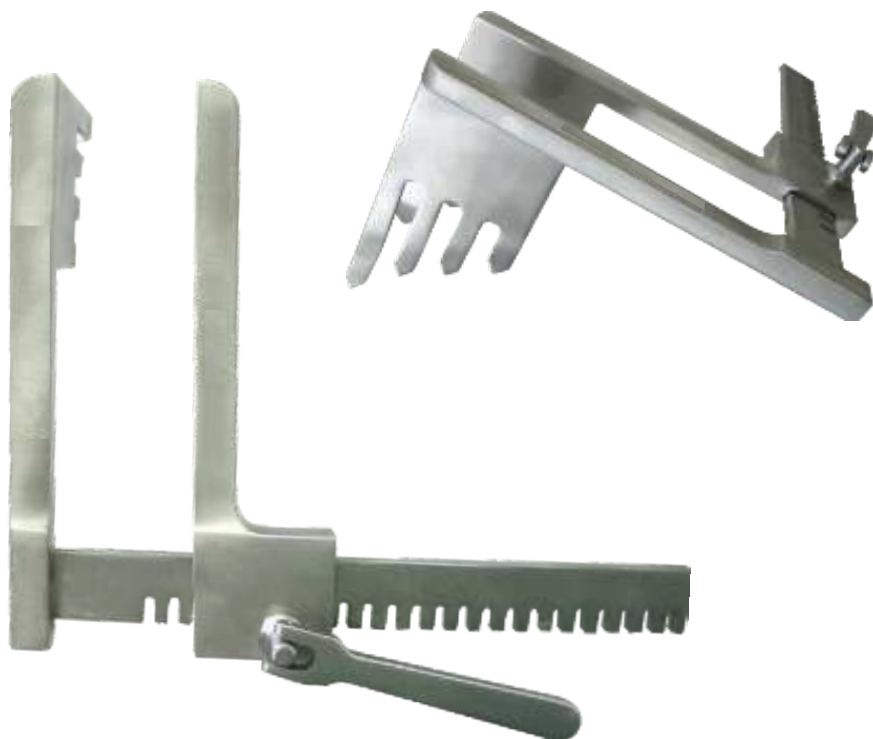

Afastador para  
coluna lombar  
abertura total  
17cm

lâminas fixas  
PH-08.1501



Afastador para  
coluna lombar articulado  
abertura total  
17cm

lâminas móveis  
PH-08.1502



### Lâminas

35x70mm PH-08.3570	50x90mm PH-08.5090
50x80mm PH-08.5080	50x100mm PH-08.5010

## Afastadores / Retratores Transversal e Longitudinal para Coluna Cervical / Lombar

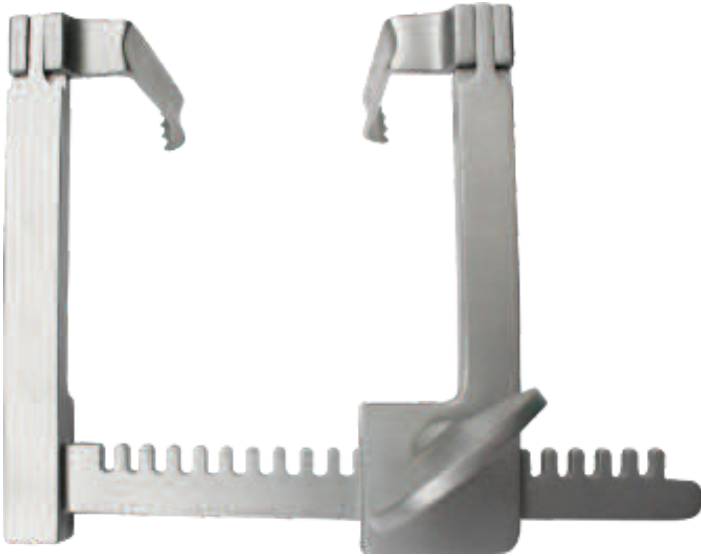

Magana  
PH-08.9000



Lâminas  
60x10mm  
com dente  
PH-08.6010  
sem dente  
PH-08.0611



Lâmina  
57x15mm  
PH-08.1602



Caspar Lombar  
16cm  
PH-08.1601

## Afastadores / Retratores Transversal e Longitudinal para Coluna Cervical

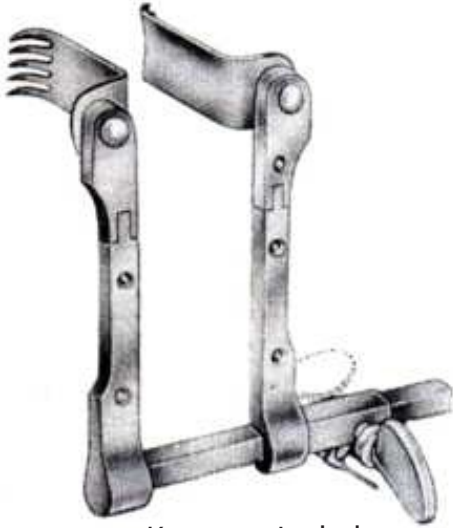

**Koros articulado**  
12cm  
com 2 pares de lâminas  
(medidas a definir)  
**PH-08.1697**

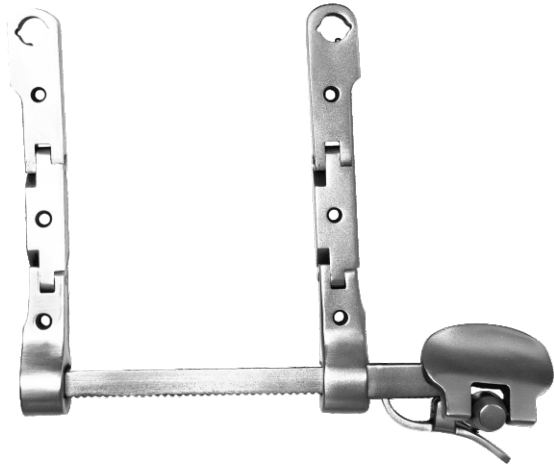

**Caspar Counter biarticulado**  
13cm  
com 3 pares de lâminas  
(medidas a definir)  
**PH-08.1705**

### Lâminas de encaixe rápido

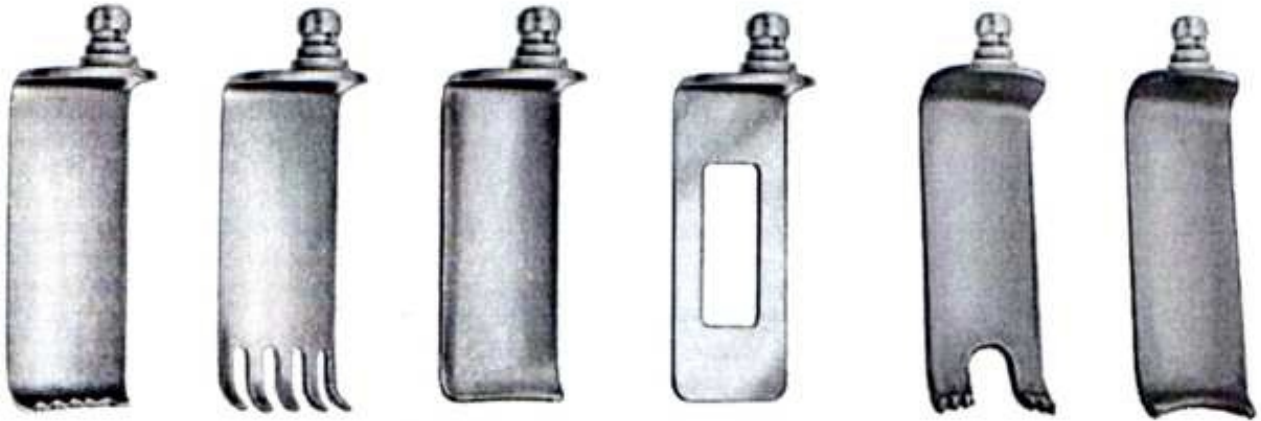

#### Lâminas Medial

23mmx45mm  
**PH-08.1682**  
23mmx50mm  
**PH-08.1683**  
23mmx55mm  
**PH-08.1684**  
23mmx60mm  
**PH-08.1685**  
23mmx65mm  
**PH-08.1686**  
23mmx70mm  
**PH-08.1687**

#### Lâminas Laterais

23mmx45mm  
**PH-08.1691**  
23mmx50mm  
**PH-08.1692**  
23mmx55mm  
**PH-08.1693**  
23mmx60mm  
**PH-08.1694**  
23mmx65mm  
**PH-08.1695**  
23mmx70mm  
**PH-08.1696**

#### Lâminas Cegas

23mmx45mm  
**PH-08.1600**  
23mmx50mm  
**PH-08.1700**  
23mmx55mm  
**PH-08.1701**  
23mmx60mm  
**PH-08.1702**  
23mmx65mm  
**PH-08.1703**  
23mmx70mm  
**PH-08.1704**

#### Lâmina Fenestrada para retirada de Enxerto Ósseo do ilíaco

25mmx50mm  
**PH-08.2550**  
25mmx60mm  
**PH-08.2560**

#### Lâminas Dissectomia

20mmx45mm  
**PH-08.1604**  
20mmx50mm  
**PH-08.1605**  
20mmx55mm  
**PH-08.1606**  
20mmx60mm  
**PH-08.1607**

#### Lâminas Longitudinal

20mmx45mm  
**PH-08.1612**  
20mmx50mm  
**PH-08.1613**  
20mmx55mm  
**PH-08.1614**  
20mmx60mm  
**PH-08.1615**



**Ejetor de lâminas**  
**PH-07.1254**

## Afastadores / Retratores Transversal e Longitudinal para Coluna Cervical



Retrator tipo espéculo  
com braços fixos

11cm

com 4 lâminas  
sem corte

23mmx45mm

23mmx50mm

23mmx55mm

23mmx60mm

PH-08.1698

Retrator tipo espéculo  
com braços articulados

15cm

com 4 lâminas  
sem corte

23mmx45mm

23mmx50mm

23mmx55mm

23mmx60mm

PH-08.1699



Lâminas  
mediais  
em titânio



Lâminas  
longitudinais  
em titânio



Lâminas  
mediais



Lâminas  
laterais



Lâminas  
longitudinais





Janetta  
conjunto completo incluindo  
1 afastador (1)  
1 lâmina curta pequena (4)  
2 barras/conector duplo (2)  
e simples (3)

**PH-08.1706**

- |  |  |
|--|--|
| 1. Apenas o Afastador<br><b>PH-08.1707</b>     | 5. Lâmina curta média<br><b>PH-08.1711</b>   |
| 2. Barra/conector duplo<br><b>PH-08.1708</b>   | 6. Lâmina curta grande<br><b>PH-08.1712</b>  |
| 3. Barra/conector simples<br><b>PH-08.1709</b> | 7. Lâmina longa pequena<br><b>PH-08.1713</b> |
| 4. Lâmina curta pequena<br><b>PH-08.1710</b>   | 8. Lâmina longa média<br><b>PH-08.1714</b>   |
|  | 9. Lâmina longa grande<br><b>PH-08.1715</b>  |



## Afastador / Retrator Cerebral Autostático Leyla-Yasargil



Leyla-Yasargil  
auto-estático duplo composto de:  
01 base para fixação craniana,  
02 braços flexíveis de aço inox,  
02 espátulas maleáveis  
[PH-09.1710](#)

Foto meramente ilustrativa em uma craniotomia.

## Afastador / Retrator Cerebral Autostático Leyla-Yasargil



Cabeçote para fixação dos  
braços do Leyla-Yasargil

PH-10.1760



Foto meramente  
ilustrativa suporte  
espátula



Espátulas medidas opcionais



Conjunto Completo Leyla-Yasargil composto de:

01 Cabeçote para fixação

dos braços Ley

02 Braços flexíveis em aço inox; 02 Espátulas maleáveis; 01 Haste / tirante tubo rígido bi-partido para sustentação constituído de 02 peças para facilitar esterilização e estocagem;

01 Cabeçote móvel fixador para mesa cirúrgica, regulável e acoplável a qualquer mesa cirúrgica.

PH-10.1763

## Acessórios e componentes

Base de fixação para  
montagem de 02 braços  
flexíveis Leyla-Yasargil  
no crânio duplo  
**PH-10.1745**



Base de fixação para montagem  
de 01 braço flexível Leyla-Yasargil  
no crânio simples  
**PH-10.1740**



Braço flexível  
de aço inox  
**PH-10.1735**



## Suporte de Mesa Cirúrgica para Afastador Retrator Cerebral Autostático Leyla-Yasargil



PH-10.1760

PH-10.1755

PH-10.1765

Conjunto completo do suporte de mesa cirúrgica para Leyla-Yasargil contendo: 01 Haste tirante tubo rígido bi-partido de sustentação, 01 cabeçote de fixação dos braços e 01 cabeçote móvel fixador para mesa cirúrgica regulável.

PH-10.1768



980mm

Haste/tirante tubo rígido bi-partido para sustentação constituído de 02 peças para facilitar esterilização e estocagem

PH-10.1755



Plataforma giratória e móvel para haste do tirante com 01 fixador para braço do Leyla-Yasargil

PH-10.1766

## Suporte de Mesa cirúrgica para Afastador Retrator Cerebral Autostático Leyla-Yasargil



Cabeçote móvel fixador  
para mesa cirúrgica,  
regulável e acoplável a  
qualquer mesa cirúrgica  
**PH-10.1765**

## Afastadores / Retratores de nervos e raízes



Love  
reto 5mm  
210mm  
PH-12.1906



Love  
angulado 45° 5mm  
210mm  
PH-12.1907



Love  
angulado 90° 5mm  
140mm  
PH-12.1908



Baioneta  
para raízes nervosas  
210mm  
PH-12.1909

## Afastadores / Retratores para coluna cervical



Cloward cervical articulado 254mm com 01 par de lâminas (escolher medida)    Cloward cervical articulado 171mm    Caspar cervical biarticulado 171mm

PH-13.1987

PH-13.1989

PH-13.1917

Kit completo com 3 pares de lâmina titânio

PH-13.1988

Kit completo com 3 pares de lâmina titânio

PH-13.1990

Kit completo com 3 pares de lâmina titânio

PH-13.1918



Lâminas medial

15x45mm  
PH-13.1945

15x50mm  
PH-13.1950

15x55mm  
PH-13.1955

15x60mm  
PH-13.1960



Lâminas cegas

15x45mm  
PH-13.2045

15x50mm  
PH-13.2050

15x55mm  
PH-13.2055

15x60mm  
PH-13.2060



## Afastadores / Retratores Expansor de Corpo Vertebral



INGE  
Expansor para corpo  
vertebral curto  
160mm  
PH-13.1961



INGE  
Expansor para corpo  
vertebral longo  
270mm  
PH-13.1962



Cloward  
150mm  
PH-13.1963



Cloward  
184mm  
PH-13.1964

Caspar Esquerdo



Guia de Broca do  
Distrator Esquerdo  
PH-15.2170



Guia do Parafuso  
Fixador do Corpo  
Vertebral  
PH-15.2180



Chassi Distrator  
Vertebral Esquerdo  
PH-15.2175



Parafuso Fixador do  
Corpo Vertebral

- 12mm  
PH-15.2112
- 14mm  
PH-15.2114
- 16mm  
PH-15.2116



Broca Twist Drill  
147mm

- Profundidade  
de perfuração 8mm  
PH-15.2200

## Caspar Direito



Guia de Broca do  
Distrator Direito  
PH-16.2210



Guia de Parafuso fixador  
do corpo vertebral  
PH-15.2180



Chassi Distrator  
Vertebral Direito  
PH-16.2215



Parafuso Fixador do  
Corpo Vertebral

12mm  
PH-15.2112  
14mm  
PH-15.2114  
16mm  
PH-15.2116



Broca Twist Drill  
147mm  
Profundidade  
de perfuração 8mm  
PH-15.2200

Chassi Distrator com guia  
de broca cervical Caspar  
PH-16.2220



### Distrator cervical caspar



Kit completo contendo:

- 01 Distrator de corpo vertebral
- 03 Impactores de enxerto ósseo
- 01 Colocador de enxerto
- 01 Dissecador de corpo vertebral
- 01 Guia de broca do distrator
- 06 Parafusos fixadores do corpo vertebral (12mm, 14mm e 16mm)
- 01 Guia do parafuso fixador do corpo vertebral

PH-16.2221



Acessórios distrator cervical caspar



Kit impactador de enxerto ósseo  
PH-16.2211

3mm  
PH-16.2203

5mm  
PH-16.2205

8mm  
PH-16.2208



Colocador de enxerto ósseo  
210mm  
Ponta 15mm  
PH-16.2212



Dissector corpo vertebral largo  
PH-16.2213

## Afastador / Espéculo Lombar para Microdissectomia



50mm  
PH-17.2250

55mm  
PH-17.2255

60mm  
PH-17.2260

65mm  
PH-17.2265

70mm  
PH-17.2270

75mm  
PH-17.2275

Imagem meramente  
ilustrativa



## Afastador / Espéculo Lombar para cirurgia Microdissectomia



50mm  
PH-17.2350

55mm  
PH-17.2355

60mm  
PH-17.2360

65mm  
PH-17.2365

70mm  
PH-17.2370

75mm  
PH-17.2375

Imagem meramente  
ilustrativa





Ejetor de lâminas  
PH-07.1254



Kit Completo Caspar inverso  
03 lâminas de titânio (escolher tamanhos)  
01 ejedor de lâminas  
03 espéculos (escolher tamanhos)  
e 03 lâminas em aço inox de medidas correspondentes aos espéculos  
PH-18.2244



Afastador/Retrator  
Caspar inverso  
PH-18.2243



Código	Comprimento
PH-18.2245	45mm
PH-18.2250	50mm
PH-18.2255	55mm
PH-18.2260	60mm
PH-18.2265	65mm
PH-18.2207	70mm





Afastador/Retrator Sofield  
kit completo com 6 peças  
PH-19.4530

### Tamanhos/Medidas

45x35x150  
PH-19.4535

85x60x180  
PH-19.8560

60x45x160  
PH-19.6045

100x65x190  
PH-19.0065

65x55x170  
PH-19.6555

115x75x200  
PH-19.1575



Broca/fresa automática Acra-cut  
Auto-travante para perfuração e trepanação  
70mm



ø9mm infantil/pediátrica

PH-20.2909

ø14mm Adulto

PH-20.1429

ø17mm Adulto

PH-20.1729



Extensão cerebelar de Hudson  
102mm

PH-20.2910



Broca perfuradora de Cushing  
102mm

ø9mm

PH-20.2911

ø13mm

PH-20.2912

ø16mm

PH-20.2913



Broca de rocha regulável  
102mm

ø9mm

PH-20.2914

ø13mm

PH-20.2916

ø11mm

PH-20.2915

ø16mm

PH-20.2917

Broca de Hudson  
102mm



ø9mm

PH-20.2918



ø11mm

PH-20.2919

ø14mm

PH-20.2920



ø9mm

PH-20.2921

ø16mm

PH-20.2922



ø20mm

PH-20.2923

ø22mm

PH-20.2924



Broca de Mackenzie  
102mm

ø13mm

PH-20.2925

ø16mm

PH-20.2926

## Brocas de Perfuração Brocas de uso Manual / Trépano / Trefina

Suporte para Broca Twist Drill  
PH-14.0484



Trépano manual de Hudson  
248mm  
PH-20.2480



Broca Twist Drill  
70mm

2,0mm  
PH-23.2902

2,5mm  
PH-23.2925

3,0mm  
PH-23.2903



Trefina D'Errico  
regulável

25mm  
PH-23.2937

38mm  
PH-23.2938

51mm  
PH-23.2951

65mm  
PH-23.2965

Fabricamos sob encomenda medidas especiais

Ponta de aspiração/tubo de sucção Frazier com mandril semi-maleável,  
pontas atraumáticas, com anel ou sem anel

medidas/milímetros

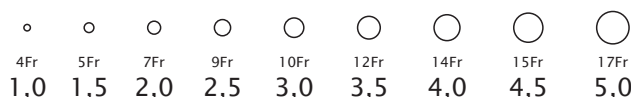

Comprimento x Diâmetro ø

PH-24.8010	80mmx1,0mm	PH-24.9010	90mmx1,0mm	PH-24.1010	100mmx1,0mm
PH-24.8015	80mmx1,5mm	PH-24.9015	90mmx1,5mm	PH-24.1015	100mmx1,5mm
PH-24.8020	80mmx2,0mm	PH-24.9020	90mmx2,0mm	PH-24.1020	100mmx2,0mm
PH-24.8025	80mmx2,5mm	PH-24.9025	90mmx2,5mm	PH-24.1025	100mmx2,5mm
PH-24.8030	80mmx3,0mm	PH-24.9030	90mmx3,0mm	PH-24.1030	100mmx3,0mm
PH-24.8035	80mmx3,5mm	PH-24.9035	90mmx3,5mm	PH-24.1035	100mmx3,5mm
PH-24.8040	80mmx4,0mm	PH-24.9040	90mmx4,0mm	PH-24.1040	100mmx4,0mm
PH-24.8045	80mmx4,5mm	PH-24.9045	90mmx4,5mm	PH-24.1045	100mmx4,5mm
PH-24.8050	80mmx5,0mm	PH-24.9050	90mmx5,0mm	PH-24.1050	100mmx5,0mm
PH-24.1110	110mmx1,0mm	PH-24.1210	120mmx1,0mm	PH-24.1310	130mmx1,0mm
PH-24.1115	110mmx1,5mm	PH-24.1215	120mmx1,5mm	PH-24.1315	130mmx1,5mm
PH-24.1120	110mmx2,0mm	PH-24.1220	120mmx2,0mm	PH-24.1320	130mmx2,0mm
PH-24.1125	110mmx2,5mm	PH-24.1225	120mmx2,5mm	PH-24.1325	130mmx2,5mm
PH-24.1130	110mmx3,0mm	PH-24.1230	120mmx3,0mm	PH-24.1330	130mmx3,0mm
PH-24.1135	110mmx3,5mm	PH-24.1235	120mmx3,5mm	PH-24.1335	130mmx3,5mm
PH-24.1140	110mmx4,0mm	PH-24.1240	120mmx4,0mm	PH-24.1340	130mmx4,0mm
PH-24.1145	110mmx4,5mm	PH-24.1245	120mmx4,5mm	PH-24.1345	130mmx4,5mm
PH-24.1150	110mmx5,0mm	PH-24.1250	120mmx5,0mm	PH-24.1350	130mmx5,0mm
PH-24.1410	140mmx1,0mm	PH-24.1510	150mmx1,0mm	PH-24.1610	160mmx1,0mm
PH-24.1415	140mm x1,5mm	PH-24.1515	150mmx1,5mm	PH-24.1615	160mmx1,5mm
PH-24.1420	140mmx2,0mm	PH-24.1520	150mmx2,0mm	PH-24.1620	160mmx2,0mm
PH-24.1425	140mmx2,5mm	PH-24.1525	150mmx2,5mm	PH-24.1625	160mmx2,5mm
PH-24.1430	140mmx3,0mm	PH-24.1530	150mmx3,0mm	PH-24.1630	160mmx3,0mm
PH-24.1435	140mmx3,5mm	PH-24.1535	150mmx3,5mm	PH-24.1635	160mmx3,5mm
PH-24.1440	140mmx4,0mm	PH-24.1540	150mmx4,0mm	PH-24.1640	160mmx4,0mm
PH-24.1445	140mmx4,5mm	PH-24.1545	150mmx4,5mm	PH-24.1645	160mmx4,5mm
PH-24.1450	140mmx5,0mm	PH-24.1550	150mmx5,0mm	PH-24.1650	160mmx5,0mm

PH-24.1710 170mmx1,0mm  
PH-24.1715 170mmx1,5mm  
PH-24.1720 170mmx2,0mm  
PH-24.1725 170mmx2,5mm  
PH-24.1730 170mmx3,0mm  
PH-24.1735 170mmx3,5mm  
PH-24.1740 170mmx4,0mm  
PH-24.1745 170mmx4,5mm  
PH-24.1750 170mmx5,0mm

PH-24.1810 180mmx1,0mm  
PH-24.1815 180mmx1,5mm  
PH-24.1820 180mmx2,0mm  
PH-24.1825 180mmx2,5mm  
PH-24.1830 180mmx3,0mm  
PH-24.1835 180mmx3,5mm  
PH-24.1840 180mmx4,0mm  
PH-24.1845 180mmx4,5mm  
PH-24.1850 180mmx5,0mm

PH-24.1910 190mmx1,0mm  
PH-24.1915 190mmx1,5mm  
PH-24.1920 190mmx2,0mm  
PH-24.1925 190mmx2,5mm  
PH-24.1930 190mmx3,0mm  
PH-24.1935 190mmx3,5mm  
PH-24.1940 190mmx4,0mm  
PH-24.1945 190mmx4,5mm  
PH-24.1950 190mmx5,0mm

PH-24.2010 200mmx1,0mm  
PH-24.2015 200mmx1,5mm  
PH-24.2020 200mmx2,0mm  
PH-24.2025 200mmx2,5mm  
PH-24.2030 200mmx3,0mm  
PH-24.2035 200mmx3,5mm  
PH-24.2040 200mmx4,0mm  
PH-24.2045 200mmx4,5mm  
PH-24.2050 200mmx5,0mm

PH-24.2110 210mmx1,0mm  
PH-24.2115 210mmx1,5mm  
PH-24.2120 210mmx2,0mm  
PH-24.2125 210mmx2,5mm  
PH-24.2130 210mmx3,0mm  
PH-24.2135 210mmx3,5mm  
PH-24.2140 210mmx4,0mm  
PH-24.2145 210mmx4,5mm  
PH-24.2150 210mmx5,0mm

PH-24.2210 220mmx1,0mm  
PH-24.2215 220mmx1,5mm  
PH-24.2220 220mmx2,0mm  
PH-24.2225 220mmx2,5mm  
PH-24.2230 220mmx3,0mm  
PH-24.2235 220mmx3,5mm  
PH-24.2240 220mmx4,0mm  
PH-24.2245 220mmx4,5mm  
PH-24.2250 220mmx5,0mm



Aspirador/afastador  
angulado para coluna

ø2,0mm  
PH-18.2680  
ø2,5mm  
PH-18.2681  
ø3,0mm  
PH-18.2682  
ø3,5mm  
PH-18.2683  
ø4,0mm  
PH-18.2684



Aspirador/afastador  
reto para coluna

ø3,5mm  
PH-18.2685  
ø4,0mm  
PH-18.2686  
ø4,5mm  
PH-18.2687



Afastador/descolador  
para Duramater  
PH-18.2688

## Aspirador / Afastador / Descolador para Crânio e Coluna Cânulas de Aspiração / Pontas para Aspiração Tubo de Sucção

Ponta de aspiração/tubo de sucção com orifício gota d'água semi-maleável,  
pontas atraumáticas para crânio e coluna.

medidas/milímetros

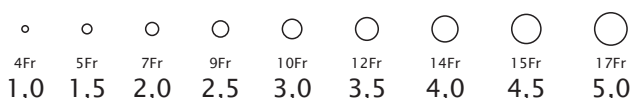

Comprimento x Diâmetro ø

PH-24.8011	80mmx1,0mm	PH-24.9011	90mmx1,0mm	PH-24.1011	100mmx1,0mm
PH-24.8016	80mmx1,5mm	PH-24.9016	90mmx1,5mm	PH-24.1016	100mmx1,5mm
PH-24.8021	80mmx2,0mm	PH-24.9021	90mmx2,0mm	PH-24.1021	100mmx2,0mm
PH-24.8026	80mmx2,5mm	PH-24.9026	90mmx2,5mm	PH-24.1026	100mmx2,5mm
PH-24.8031	80mmx3,0mm	PH-24.9031	90mmx3,0mm	PH-24.1031	100mmx3,0mm
PH-24.8036	80mmx3,5mm	PH-24.9036	90mmx3,5mm	PH-24.1036	100mmx3,5mm
PH-24.8041	80mmx4,0mm	PH-24.9041	90mmx4,0mm	PH-24.1041	100mmx4,0mm
PH-24.8046	80mmx4,5mm	PH-24.9046	90mmx4,5mm	PH-24.1046	100mmx4,5mm
PH-24.8051	80mmx5,0mm	PH-24.9051	90mmx5,0mm	PH-24.1051	100mmx5,0mm
PH-24.1111	110mmx1,0mm	PH-24.1211	120mmx1,0mm	PH-24.1311	130mmx1,0mm
PH-24.1116	110mmx1,5mm	PH-24.1216	120mmx1,5mm	PH-24.1316	130mmx1,5mm
PH-24.1121	110mmx2,0mm	PH-24.1221	120mmx2,0mm	PH-24.1321	130mmx2,0mm
PH-24.1126	110mmx2,5mm	PH-24.1226	120mmx2,5mm	PH-24.1326	130mmx2,5mm
PH-24.1131	110mmx3,0mm	PH-24.1231	120mmx3,0mm	PH-24.1331	130mmx3,0mm
PH-24.1136	110mmx3,5mm	PH-24.1236	120mmx3,5mm	PH-24.1336	130mmx3,5mm
PH-24.1141	110mmx4,0mm	PH-24.1241	120mmx4,0mm	PH-24.1341	130mmx4,0mm
PH-24.1146	110mmx4,5mm	PH-24.1246	120mmx4,5mm	PH-24.1346	130mmx4,5mm
PH-24.1151	110mmx5,0mm	PH-24.1251	120mmx5,0mm	PH-24.1351	130mmx5,0mm
PH-24.1411	140mmx1,0mm	PH-24.1511	150mmx1,0mm	PH-24.1611	160mmx1,0mm
PH-24.1416	140mmx1,5mm	PH-24.1516	150mmx1,5mm	PH-24.1616	160mmx1,5mm
PH-24.1421	140mmx2,0mm	PH-24.1521	150mmx2,0mm	PH-24.1621	160mmx2,0mm
PH-24.1426	140mmx2,5mm	PH-24.1526	150mmx2,5mm	PH-24.1626	160mmx2,5mm
PH-24.1431	140mmx3,0mm	PH-24.1531	150mmx3,0mm	PH-24.1631	160mmx3,0mm
PH-24.1436	140mmx3,5mm	PH-24.1536	150mmx3,5mm	PH-24.1636	160mmx3,5mm
PH-24.1441	140mmx4,0mm	PH-24.1541	150mmx4,0mm	PH-24.1641	160mmx4,0mm
PH-24.1446	140mmx4,5mm	PH-24.1546	150mmx4,5mm	PH-24.1646	160mmx4,5mm
PH-24.1451	140mmx5,0mm	PH-24.1551	150mmx5,0mm	PH-24.1651	160mmx5,0mm
PH-24.1711	170mmx1,0mm	PH-24.1811	180mmx1,0mm	PH-24.1911	190mmx1,0mm
PH-24.1716	170mmx1,5mm	PH-24.1816	180mmx1,5mm	PH-24.1916	190mmx1,5mm
PH-24.1721	170mmx2,0mm	PH-24.1821	180mmx2,0mm	PH-24.1921	190mmx2,0mm
PH-24.1726	170mmx2,5mm	PH-24.1826	180mmx2,5mm	PH-24.1926	190mmx2,5mm
PH-24.1731	170mmx3,0mm	PH-24.1831	180mmx3,0mm	PH-24.1931	190mmx3,0mm
PH-24.1736	170mmx3,5mm	PH-24.1836	180mmx3,5mm	PH-24.1936	190mmx3,5mm
PH-24.1741	170mmx4,0mm	PH-24.1841	180mmx4,0mm	PH-24.1941	190mmx4,0mm
PH-24.1746	170mmx4,5mm	PH-24.1846	180mmx4,5mm	PH-24.1946	190mmx4,5mm
PH-24.1751	170mmx5,0mm	PH-24.1851	180mmx5,0mm	PH-24.1951	190mmx5,0mm

Cânulas de Aspiração / Pontas para Aspiração  
Tubo de Sucção / Aspirador Cânula de Sucção Lombar



Adson com mandril  
comprimento x diâmetro ø

- 2,0x190mm  
PH-25.1920
- 2,5x190mm  
PH-25.1925
- 3,0x190mm  
PH-25.1930
- 3,5x190mm  
PH-25.1935
- 4,0x190mm  
PH-25.1940
- 4,5x190mm  
PH-25.1945
- 5x190mm  
PH-25.1950



Aspirador/Retrator Williams  
para micro cirurgia lombar

152mm  
ø5mm  
PH-25.2235

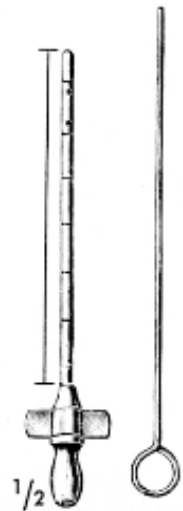

- Frazier graduada 100mm ø1,5mm PH-25.1015
- Frazier graduada 100mm ø2,0mm PH-25.1020
- Frazier graduada 100mm ø2,5mm PH-25.1025
- Frazier graduada 100mm ø3,0mm PH-25.1030

Cânula ventricular de Frazier com mandril e aba graduada  
70mm  
ø2,0mm PH-25.1040  
ø2,5mm PH-25.1045

## Cabos para Lâmina de Bisturi Convencional



Curto  
lâmina 3  
130mm  
PH-25.1210



Longo/Reto  
lâmina 3  
210mm  
PH-25.2103

Longo/angulado  
lâmina 3  
PH-25.2003

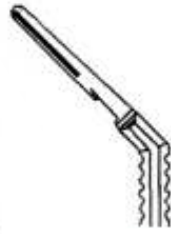

Curto  
lâmina 4  
130mm  
PH-25.1404



Longo/Reto  
lâmina 4  
210mm  
PH-25.2104

Longo/angulado  
lâmina 4  
PH-25.2004





## Cabos para Lâmina de Bisturi Convencional / Baioneta



125mm  
curto  
lâmina 7k  
PH-25.1207



160mm  
longo  
lâmina 7  
PH-25.1607



270mm  
reto  
longo  
PH-25.0027



340mm  
baioneta longo  
corte vertical  
PH-25.0034



200mm  
baioneta  
corte vertical  
PH-14.0901

200mm  
baioneta  
corte horizontal  
PH-25.2010

## Cinzel Goivas Osteótomos para Osso

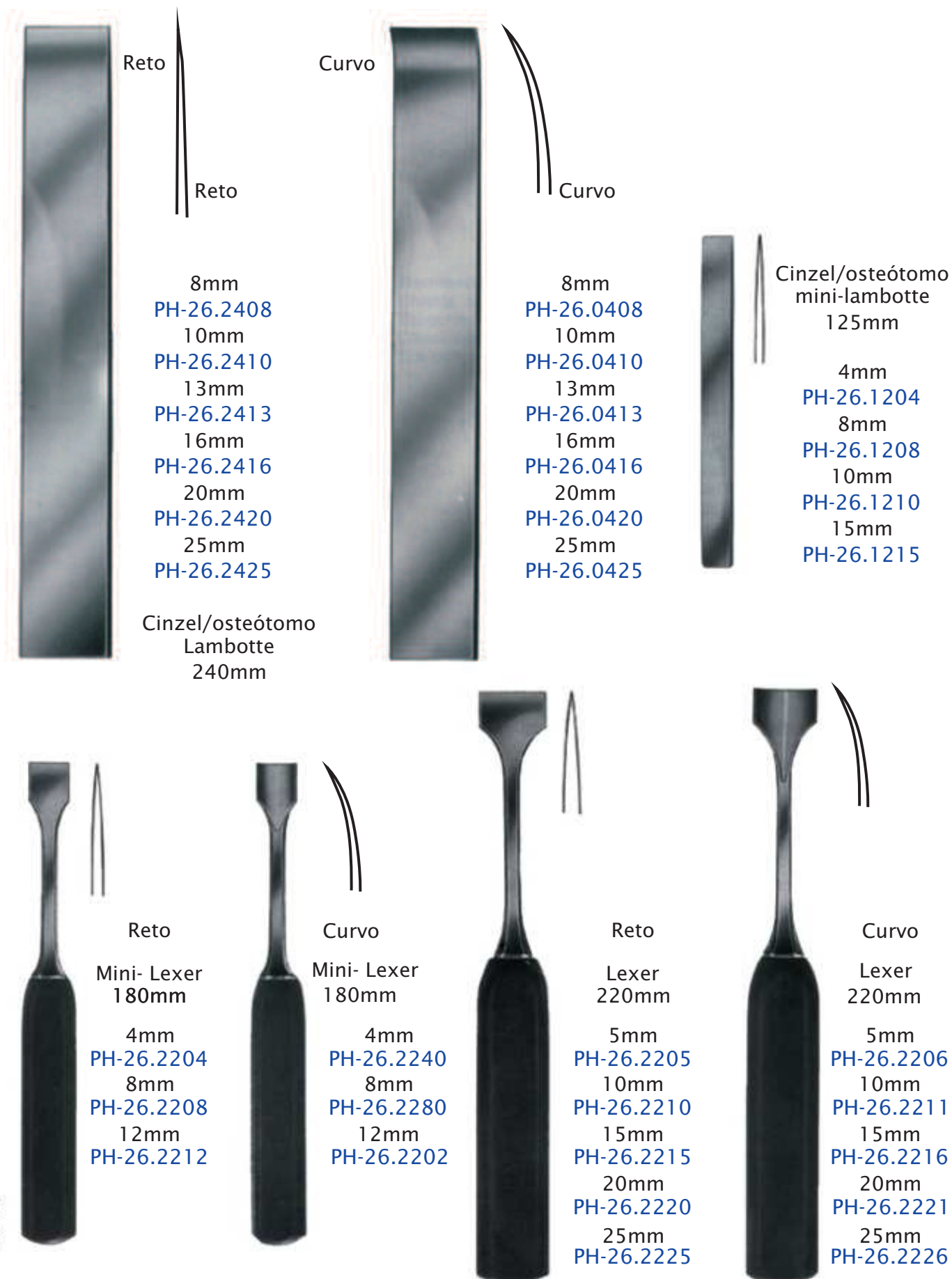

## Cinzel Goivas Osteótomos para Osso

### Stille



6mm	PH-26.2060	PH-27.2060	PH-28.2060	PH-29.2060	PH-30.2060
8mm	PH-26.2080	PH-27.2080	PH-28.2080	PH-29.2080	PH-30.2080
10mm	PH-26.2010	PH-27.2010	PH-28.2010	PH-29.2010	PH-30.2010
12mm	PH-26.2012	PH-27.2012	PH-28.2012	PH-29.2012	PH-30.2012
15mm	PH-26.2015	PH-27.2015	PH-28.2015	PH-29.2015	PH-30.2015
20mm	PH-26.2020	PH-27.2020	PH-28.2020	PH-29.2020	PH-30.2020
25mm	PH-26.2025	PH-27.2025	PH-28.2025	PH-29.2025	PH-30.2025
30mm	PH-26.2030	PH-27.2030	PH-28.2030	PH-29.2030	PH-30.2030

### Hibbs 240mm



6mm	PH-31.2460	PH-32.2460	PH-33.2460	PH-34.2460	PH-35.2460
9mm	PH-31.2490	PH-32.2490	PH-33.2490	PH-34.2490	PH-35.2490
13mm	PH-31.2413	PH-32.2413	PH-33.2413	PH-34.2413	PH-35.2413
16mm	PH-31.2416	PH-32.2416	PH-33.2416	PH-34.2416	PH-35.2416
19mm	PH-31.2419	PH-32.2419	PH-33.2419	PH-34.2419	PH-35.2419
25mm	PH-31.2425	PH-32.2425	PH-33.2425	PH-34.2425	PH-35.2425
32mm	PH-31.2432	PH-32.2432	PH-33.2432	PH-34.2432	PH-35.2432

## Cinzel para Osso / Goivas Osteótomos Para Osso



Smith-Petersen  
200mm



**Reto**  
16mm  
PH-46.2016  
19mm  
PH-46.2019  
25mm  
PH-46.2500  
30mm  
PH-46.2030



**Curvo**  
16mm  
PH-46.2017  
19mm  
PH-46.2020  
25mm  
PH-46.2026  
30mm  
PH-46.2034



Cinzel de Killian  
Claus canulado  
185mm  
PH-25.2018



Cloward  
240mm

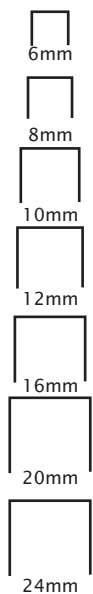

PH-46.2406  
PH-46.0824  
PH-46.2410  
PH-46.2412  
PH-46.2416  
PH-46.2420  
PH-46.2424



PH-46.2460  
PH-46.2480  
PH-46.2401  
PH-46.2421  
PH-46.2461  
PH-46.2402  
PH-46.2442



**Reto**  
5mm  
PH-46.2050  
8mm  
PH-46.2080



**Curvo**  
5mm  
PH-46.2051  
8mm  
PH-46.2081

Cinzel Hoke  
200mm

## Cinzel / Instrumentos Nasais Transfenoidal



Freer  
160mm  
PH-26.1640



Freer  
160mm  
PH-26.1641



Freer  
160mm  
PH-26.1660



Ballenger  
160mm  
PH-26.1642



Killian  
160mm  
PH-26.1643



Killian-Claus  
160mm  
PH-26.1644



4mm  
PH-26.1840



7mm  
PH-26.1870



9mm  
PH-26.1890



12mm  
PH-26.1812

Cottle  
180mm



Cottle  
180mm  
PH-26.1813



Cottle  
160mm  
PH-26.1618



reto  
4mm  
PH-26.1805  
6mm  
PH-26.1806  
8mm  
PH-26.1808  
10mm  
PH-26.1810  
12mm  
PH-26.1818

Cottle  
180mm



curvo  
4mm  
PH-26.1804  
7mm  
PH-26.1807  
9mm  
PH-26.1809  
12mm  
PH-26.1218

## Curetas de Fusão Espinhal Curetas para Osso



Caspar  
230mm



Cureta reta  
3,6mm  
PH-39.2536



Cureta reta  
4,4mm  
PH-39.2544



Cureta reta  
5,2mm  
PH-39.2552



Cureta reta  
6,0mm  
PH-39.2560



Caspar  
230mm



Cureta angulada  
3,6mm  
PH-39.2561



Cureta angulada  
4,4mm  
PH-39.2562



Cureta angulada  
5,2mm  
PH-39.2563



Cureta angulada  
6,0mm  
PH-39.2564



Caspar  
ângulo reverso  
230mm

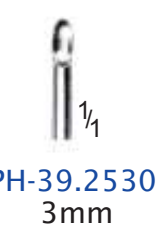

PH-39.2530  
3mm

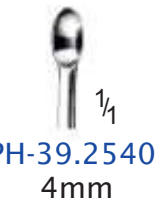

PH-39.2540  
4mm

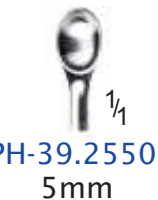

PH-39.2550  
5mm

### Ponta Concha Oval



Cureta de Simon  
240mm

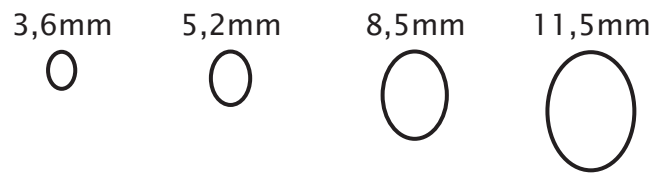
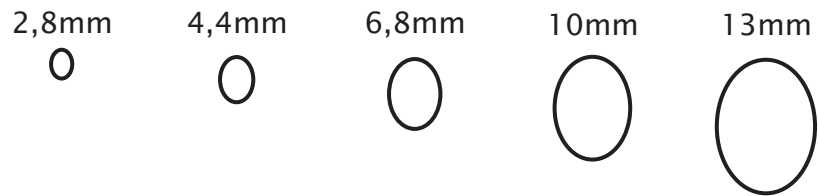

ponta reta



ponta angulada

Figura	Reta	Referência	Angulada	Referência
0000	2,8mm	PH-39.2428	2,8mm	PH-39.2417
000	3,6mm	PH-39.2436	3,6mm	PH-39.2418
00	4,4mm	PH-39.2444	4,4mm	PH-39.2419
0	5,2mm	PH-39.2452	5,2mm	PH-39.2420
1	6,8mm	PH-39.2468	6,8mm	PH-39.2421
2	8,5mm	PH-39.2485	8,5mm	PH-39.2422
3	10,0mm	PH-39.2410	10,0mm	PH-39.2423
4	11,5mm	PH-39.2411	11,5mm	PH-39.2424
5	13,0mm	PH-39.2413	13,0mm	PH-39.2425

## Curetas de Fusão Espinhal Curetas para Osso





## Curetas de Fusão Espinhal Curetas para Osso

Ponta concha redonda



Volkmann  
170mm



Figura	Reta	Referência	Angulada	Referência
0000	2,8mm	PH-39.1775	2,8mm	PH-39.1785
000	3,6mm	PH-39.1776	3,6mm	PH-39.1786
00	4,4mm	PH-39.1777	4,4mm	PH-39.1787
0	5,2mm	PH-39.1778	5,2mm	PH-39.1788
1	6,8mm	PH-39.1779	6,8mm	PH-39.1789
2	8,5mm	PH-39.1780	8,5mm	PH-39.1790
3	10,0mm	PH-39.1781	10,0mm	PH-39.1791
4	11,5mm	PH-39.1782	11,5mm	PH-39.1792



Volkmann  
270mm





Figura	Reta	Referência
000	3,6mm	PH-39.2701
00	4,4mm	PH-39.2702
0	5,2mm	PH-39.2703
1	6,8mm	PH-39.2704
2	8,5mm	PH-39.2705
3	10,0mm	PH-39.2706
4	11,5mm	PH-39.2707

## Curetas de Fusão Espinhal Curetas para Osso

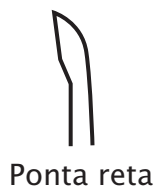

  
Ponta ângulo  
reverso

Epstein  
200mm



  
reta

Spinal  
200mm



  
angulada

Spinal  
200mm

Figura	Epstein Ângulo Reverso	Referência	Spinal Reta	Referência	Spinal Angulada	Referência
000	3,6mm	<a href="#">PH-39.2001</a>	3,6mm	<a href="#">PH-39.2010</a>	3,6mm	<a href="#">PH-39.2019</a>
00	4,4mm	<a href="#">PH-39.2002</a>	4,4mm	<a href="#">PH-39.2011</a>	4,4mm	<a href="#">PH-39.2020</a>
0	5,2mm	<a href="#">PH-39.2003</a>	5,2mm	<a href="#">PH-39.2012</a>	5,2mm	<a href="#">PH-39.2021</a>
1	6,8mm	<a href="#">PH-39.2004</a>	6,8mm	<a href="#">PH-39.2013</a>	6,8mm	<a href="#">PH-39.2022</a>
2	8,5mm	<a href="#">PH-39.2005</a>	8,5mm	<a href="#">PH-39.2014</a>	8,5mm	<a href="#">PH-39.2023</a>
3	10,0mm	<a href="#">PH-39.2006</a>	10,0mm	<a href="#">PH-39.2015</a>	10,0mm	<a href="#">PH-39.2024</a>
4	11,5mm	<a href="#">PH-39.2007</a>	11,5mm	<a href="#">PH-39.2016</a>	11,5mm	<a href="#">PH-39.2025</a>
5	13,0mm	<a href="#">PH-39.2008</a>	13,0mm	<a href="#">PH-39.2017</a>	13,0mm	<a href="#">PH-39.2026</a>

## Curetas Especiais / Via Lateral Cirurgia Tóraco Lombor Transforaminal



Spinal reta  
modelo Sisco  
230mm



Reta

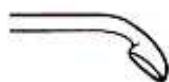

Angulada 40°



Angulada 90°



Angulo reverso

Fig.

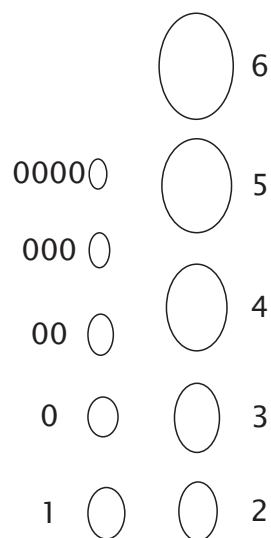

Medidas

Comprimento x Largura	
0000	2,3x3,5mm
000	2,8x3,9mm
00	3,0x4,6mm
0	3,3x5,0mm
1	4,1x6,9mm
2	5,0x7,5mm
3	5,5x8,4mm
4	7,5x10,9mm
5	8,8x12,5mm
6	9,9x14,5mm

Figura	Reta	Angulada 40°	Angulada 90°	Ang. Reverso p/ Cima
0000	PH-39.2325	PH-39.2335	PH-39.2345	PH-39.2359
000	PH-39.2326	PH-39.2336	PH-39.2346	PH-39.2360
00	PH-39.2327	PH-39.2337	PH-39.2347	PH-39.2361
0	PH-39.2328	PH-39.2338	PH-39.2348	PH-39.2362
1	PH-39.2329	PH-39.2339	PH-39.2349	PH-39.2363
2	PH-39.2330	PH-39.2340	PH-39.2350	PH-39.2364
3	PH-39.2331	PH-39.2341	PH-39.2355	PH-39.2365
4	PH-39.2332	PH-39.2342	PH-39.2356	PH-39.2366
5	PH-39.2333	PH-39.2343	PH-39.2357	PH-39.2367
6	PH-39.2334	PH-39.2344	PH-39.2358	PH-39.2368

## Curetas de Fusão Espinhal Curetas para Osso



Fig. 00  
3,0x4,6mm  
PH-39.1701



Fig. 0  
3,3x5,0mm  
PH-39.1702



Fig. 1  
4,1x6,9mm  
PH-39.1703



Fig. 2  
5,0x7,5mm  
PH-39.1704  
Ponta Oval



Fig. 00  
3,0x3,0mm  
PH-39.1705



Fig. 0  
3,3x3,5mm  
PH-39.1706



Fig. 1  
4,1x4,0mm  
PH-39.1707



Fig. 2  
5,0x5,0mm  
PH-39.1708  
Ponta Redonda



Fig. 000 2,8x3,9mm  
PH-39.2101



Fig. 00 3,0x4,6mm  
PH-39.2102



Fig. 0 3,3x5,0mm  
PH-39.2103



Fig. 1 4,1x6,9mm  
PH-39.2104



Fig. 2 5,0x7,5mm  
PH-39.2105



Fig. 3 5,5x8,4mm  
PH-39.2106





Fig. 4 7,5x10,9mm  
PH-39.2107

Ponta reta

Willinger  
170mm



Ponta  
redonda

Ponta  
oval

Spinal  
ponta dupla  
210mm

## Curetas Especiais / Via Lateral Cirurgia Tóraco Lombor Transforaminal



Spinal  
em Baioneta  
Modelo Sisco  
230mm



Fig.

0000 ○

000 ○

00 ○

0 ○

Medidas

Comprimento x Largura	
0000	2,3x3,5mm
000	2,8x3,9mm
00	3,0x4,6mm
0	3,3x5,0mm



Spinal  
em curva  
Modelo Sisco  
200mm

Figura	Reta	Angulada 40°	Angulada 90°	Ang. Reverso p/ Cima	Ang. Reverso p/ Baixo
0000	PH-39.2369	PH-39.2373	PH-39.2377	PH-39.2381	PH-39.2385
000	PH-39.2370	PH-39.2374	PH-39.2378	PH-39.2382	PH-39.2386
00	PH-39.2371	PH-39.2375	PH-39.2379	PH-39.2383	PH-39.2387
0	PH-39.2372	PH-39.2376	PH-39.2380	PH-39.2384	PH-39.2388



Spinal Reta  
230mm

Fig.

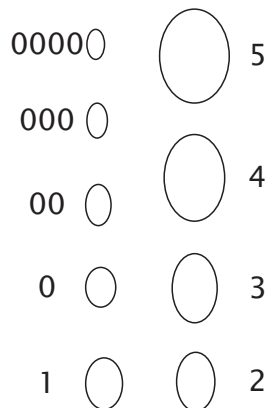

Medidas

Comprimento x Largura	
0000	2,3x3,5mm
000	2,8x3,9mm
00	3,0x4,6mm
0	3,3x5,0mm
1	4,1x6,9mm
2	5,0x7,5mm
3	5,5x8,4mm
4	7,5x10,9mm
5	8,8x12,5mm

Figura	Reta	Angulada 40°
0000	PH-49.2442	PH-39.4035
000	PH-39.2839	PH-39.4039
00	PH-39.3046	PH-39.4046
0	PH-39.3350	PH-39.4050
1	PH-39.4169	PH-39.4069
2	PH-39.5075	PH-39.4075
3	PH-39.5584	PH-39.4084
4	PH-39.7510	PH-39.4010
5	PH-39.8812	PH-39.4012

## Curetas Fenestradas



em forma  
4mmx8mm  
PH-39.2548



em forma  
5mmx8mm  
PH-39.2558



Caspar reta  
ponta semi-angulada  
250mm

com dente  com dente  
4mmx8mm 5mmX8mm  
PH-39.2549 PH-39.4559



em forma  
3mmx7mm  
PH-39.2737



em forma  
4 mmx7mm  
PH-39.2747



Caspar angulada  
ponta fortemente angulada  
270mm

com dente  com dente  
3mmx7mm 4mmx7mm  
PH-39.2738 PH-39.2748

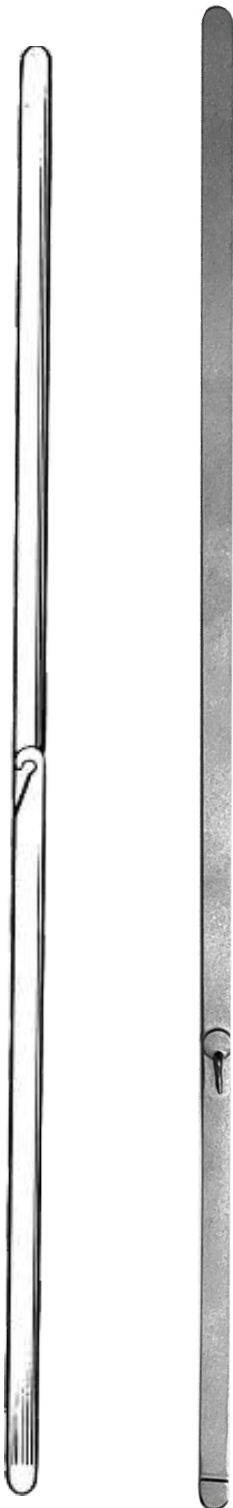

duplo  
PH-41.0279  
279mm

simples  
PH-41.3050  
305mm

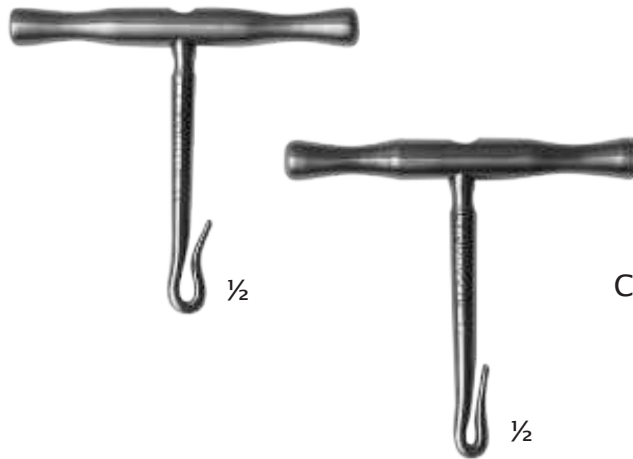

Cabo de serra de  
Gigli 51 mm  
(PAR)  
PH-41.5101

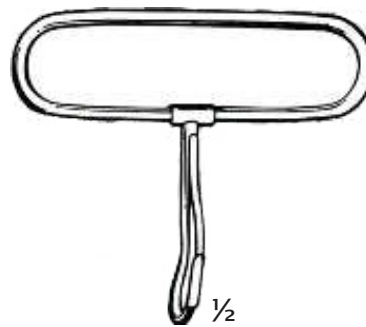

Cabo de serra de Gigli  
modelo Strully Gigli com  
dispositivo de travamento  
PH-41.8001



Serra de Gigli  
em aço inox  
300mm  
PH-41.0300  
400mm  
PH-41.0400  
500mm  
PH-41.0500



condutor Guia de Serra de Gigli  
modelo de Martel maleável



## Descoladores / Elevadores Periosteio Instrumentos para Cirurgia de Coluna e Quadril

Descolador de Cobb  
31,5mm

Lâmina  
cega 10mm  
PH-42.2710

Lâmina  
cega 15mm  
PH-42.2715

Lâmina  
cega 20mm  
PH-42.2720

Lâmina  
cega 22mm  
PH-42.2831

Lâmina  
cega 25mm  
PH-42.2725

Lâmina  
cega 30mm  
PH-42.2730

Lâmina  
cega 32mm  
PH-42.2832

Lâmina  
cega 35mm  
PH-42.2735



Lâmina cortante  
10mm  
PH-42.2742

Lâmina cortante  
15mm  
PH-42.2743

Lâmina cortante  
20mm  
PH-42.2744

Lâmina cortante  
22mm  
PH-42.2833

Lâmina cortante  
25mm  
PH-42.2745

Lâmina cortante  
30mm  
PH-42.2746

Lâmina cortante  
32mm  
PH-42.2834

Lâmina cortante  
35mm  
PH-42.2747

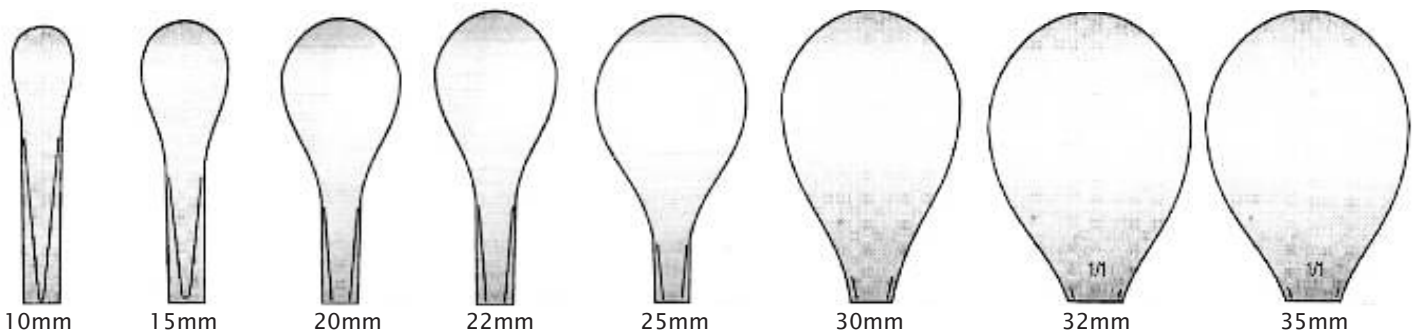



Descolador  
Cobb reto estreito  
280mm

PH-42.2840



Descolador  
Cobb curvo suave  
280mm

5mm  
PH-42.2841

10mm  
PH-42.2842

15mm  
PH-42.2843



Descolador  
Cobb curvo forte  
280mm

5mm  
PH-42.2844

10mm  
PH-42.2845

15mm  
PH-42.2846



Descolador  
Cobb curvo reverso  
280mm

PH-42.2847

## Descoladores / Elevadores Periósteo Instrumentos para Cirurgia de Coluna e Quadril





Descolador  
Lexer 279mm

semi curvo

10mm  
PH-42.2731

15mm  
PH-42.2732

20mm  
PH-42.2733

25mm  
PH-42.2734

30mm  
PH-42.2703



Descolador  
Lexer curvo  
250mm

5mm  
PH-42.2543

10mm  
PH-42.2544

15mm  
PH-42.2545

Descolador  
Lexer reto  
250mm

5mm  
PH-42.2540

10mm  
PH-42.2541

15mm  
PH-42.2542



Descolador Lexer  
280mm

5mm  
PH-42.2837

10mm  
PH-42.2838

15mm  
PH-42.2839

## Descoladores / Elevadores Periosteos Instrumentos para Cirurgia de Coluna e Quadril

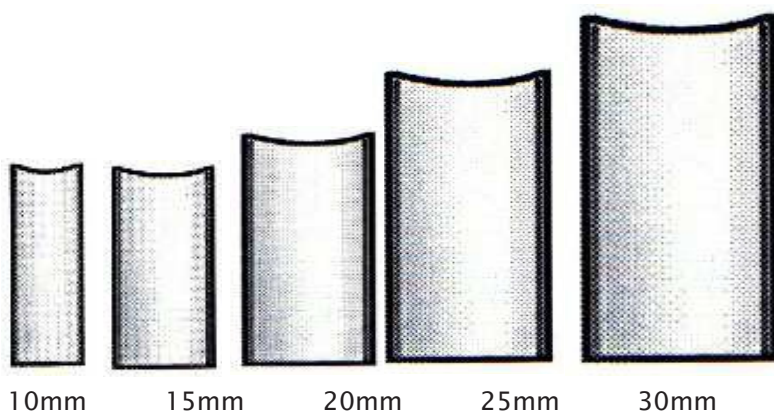

Descolador  
Lexer fortemente curvo  
285mm

10mm  
PH-42.2810

15mm  
PH-42.2815

20mm  
PH-42.2820

25mm  
PH-42.2825

30mm  
PH-42.2830

1/2



Descolador Lexer curvo  
275mm

9mm  
PH-42.2709

16mm  
PH-42.2716

20mm  
PH-42.2741

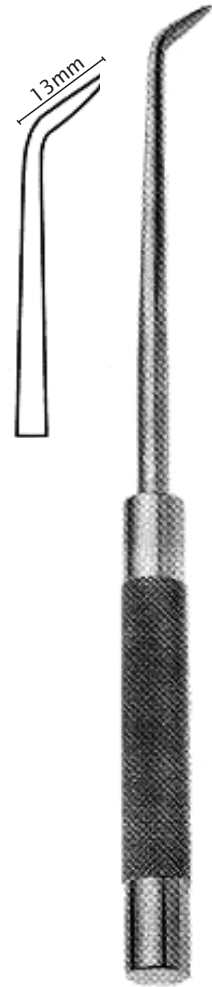

Osteótomo Spinal  
Annular 220mm  
PH-60.2201



Osteótomo spinal  
241mm

reto	curvo
6mm PH-60.2406	6mm PH-60.2460
8mm PH-60.2408	8mm PH-60.2480
10mm PH-60.2410	10mm PH-60.2401
15mm PH-60.2415	15mm PH-60.2405
20mm PH-60.2420	20mm PH-60.2402

## Descoladores / Elevadores Extra Longo



Descolador Karlin  
340mm

10mm  
PH-42.3310

15mm  
PH-42.3315

20mm  
PH-42.3320

25mm  
PH-42.3325

30mm  
PH-42.3330

35mm  
PH-42.3335

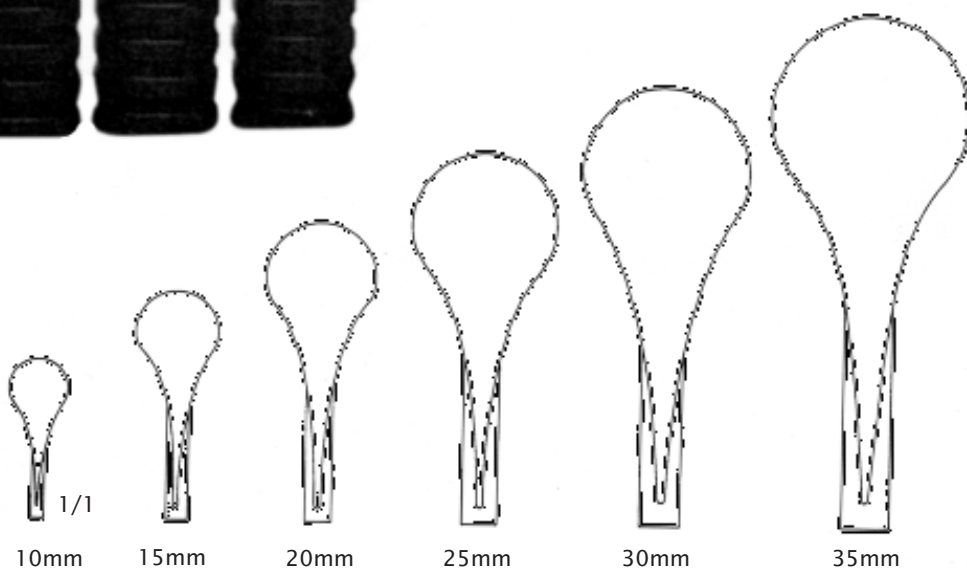

10mm

15mm

20mm

25mm

30mm

35mm

Adson reto  
165mm  
ponta quadrada 8mm  
mod. 1

PH-43.1608



Adson cuvo  
165mm  
ponta semi afiada 6mm  
mod. 2

PH-43.1606



Adson curvo  
165mm  
ponta romba 6mm  
mod. 3

PH-43.1607



Adson reto  
165mm  
ponta reta 8mm  
mod. 4

PH-43.1609



Cushing reto  
216mm  
ponta redonda afiada 6mm

PH-43.2106



Cushing  
191mm  
ponta redonda afiada 6mm

PH-43.1906





Cushing Little Joker  
152mm  
ponta estreita 6mm  
**PH-44.1526**



Cushing Little Joker  
191mm  
ponta estreita 6mm  
**PH-44.1916**



Cushing  
184mm  
ponta arredondada 16mm  
**PH-44.1841**



Cushing  
184mm  
ponta reta 16mm  
**PH-44.1842**



Elevador periósteo forte  
203mm  
lâmina 5mm  
**PH-44.2035**



Elevador periósteo forte  
203mm  
largura lâmina 12mm  
**PH-44.2012**



Elevador Periósteo Forte  
203mm  
lâmina 6,4mm  
**PH-44.2064**



## Descoladores / Dissectores Elevadores para Duramater / Cinzel



Freer  
210mm  
PH-43.2101



Freer  
222mm  
PH-43.2201



Freer  
195mm  
PH-54.1553  
230mm  
PH-54.2300



Davis  
240mm  
PH-43.2405



afiado/agudo  
cortante  
210mm  
PH-43.2204

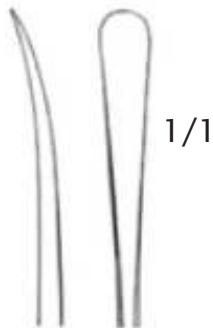

cego/rombo  
220mm  
PH-43.2202



Woodson  
250mm  
PH-43.2501

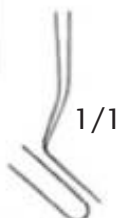
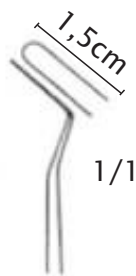

Yasargil  
195mm  
PH-54.1955



230mm  
PH-54.2301



## Descoladores / Dissectores Elevadores para Duramater / Cinzel



Milligan  
210mm  
PH-43.2104



Olivercrona  
180mm  
PH-43.1802



Olivercrona  
195mm  
PH-43.1951  
240mm  
PH-43.2406



Olivercrona  
195mm  
PH-43.1952  
230mm  
PH-43.1954

Olivercrona  
240mm  
PH-43.2404



Olivercrona longo  
290mm  
PH-43.2901



Olivercrona  
240mm



suavemente  
curvo



fortemente  
curvo

suavemente curvo  
PH-43.2403

fortemente curvo  
PH-43.2402



Descolador/Afastador  
para duramater coluna  
225mm

PH-43.2689



## Descoladores / Dissectores Elevadores para Duramater / Cinzel

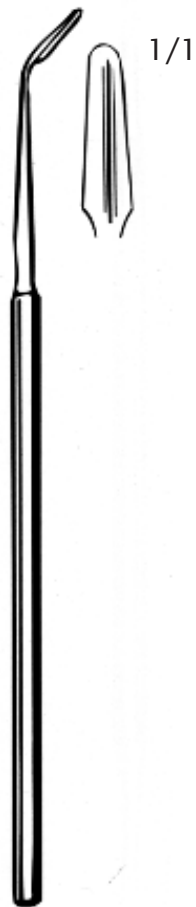

Frazier  
165mm  
PH-43.1610



165mm

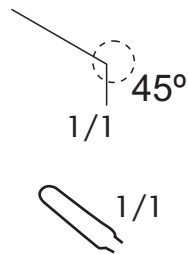

Hoehn  
PH-43.1613

1/1

Hoehn  
PH-43.1614

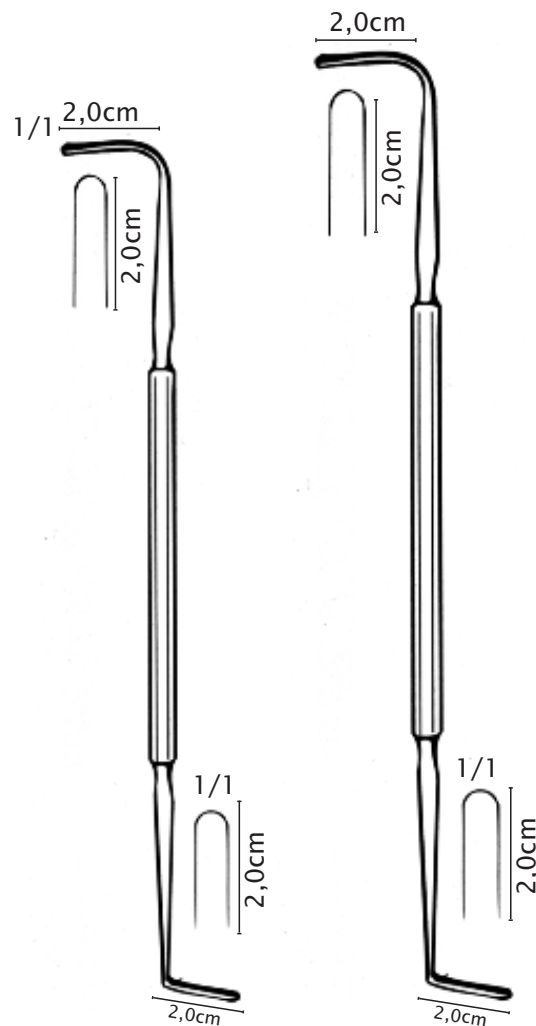

Prof. Gusmão  
180mm  
PH-43.1801

Prof. Gusmão  
240mm  
PH-43.2401



Lempert  
curvo  
180mm  
PH-54.1801



Lempert  
meio curvo  
180mm  
PH-54.1802

## Descoladores / Dissectores Elevadores para Duramater e Periosteio



1/1

Sachs  
210mm  
PH-43.2102



1/1

Sachs  
210mm  
PH-43.2103



1/1

Sachs  
210mm  
PH-43.2105  
237mm  
PH-43.2370



François  
200mm  
PH-43.2001

Elevador crego periosteal ponta romba  
200mm



PH-60.2000

8mm  
PH-60.2000



PH-60.2001

8mm  
PH-60.2001

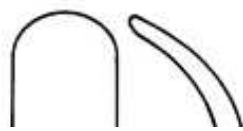

PH-60.2002

14mm  
PH-60.2002





Tonnis  
250mm  
PH-43.2502

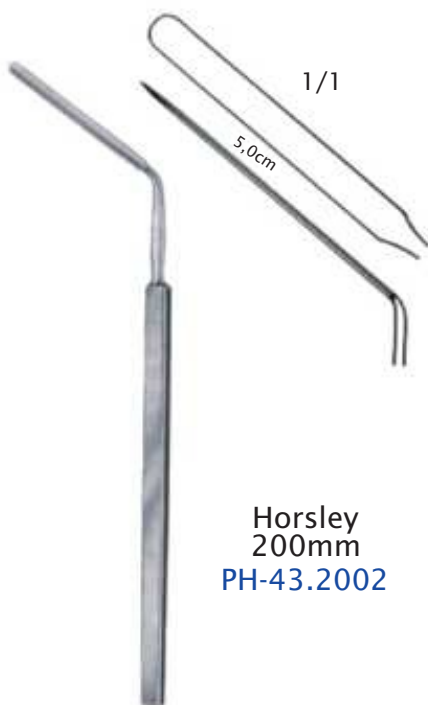

Horsley  
200mm  
PH-43.2002



Love-Adson  
160mm  
PH-43.1615



1/1  
cortante



1  
Penfield's n° 1  
203mm  
PH-43.2031



2  
cureta em concha afiada  
Penfield's n° 2  
197mm  
PH-43.1972



3  
cureta em concha afiada  
Penfield's n°3  
197mm  
PH-43.1973



4  
ponta curva suave cega  
Penfield's n°4  
197mm  
PH-43.2904



5  
Penfield's n°5  
290mm  
PH-43.2905

afiada/cortante

afiada/cortante

afiada/cortante



Espéculo Mathieu  
Trivalve  
ø15xø18x70mm  
PH-26.1600





Cottle  
150mm



75mm  
PH-36.1575



95mm  
PH-36.1595



Espéculo nasal  
150mm

80mm  
PH-38.8081

90mm  
PH-38.9091

100mm  
PH-38.1001



Killian  
150mm

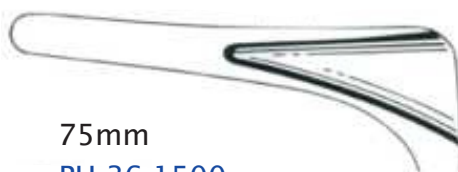

75mm  
PH-36.1500



95mm  
PH-36.1505



Espéculo nasal delicado com  
acesso endoscópico

70mm  
PH-38.7010  
80mm  
PH-38.9010  
100mm  
PH-38.1010



Espéculo nasal  
delicado

70mm  
PH-38.7070  
80mm  
PH-38.8080  
90mm  
PH-38.9090  
100mm  
PH-38.1000



Espéculo de  
Cushing

70mm  
PH-38.7015  
90mm  
PH-38.9015



## Espátulas Maleáveis Cerebrais / Facas Giratórias Instrumentos Nasais / Elevadores de Septo



Espátula  
180mm

7x9mm  
PH-12.0709  
11x13mm  
PH-12.1113  
15x18mm  
PH-12.1518  
18x22mm  
PH-12.1802



Espátula  
180mm

6mm  
PH-12.1806  
8mm  
PH-12.1808  
10mm  
PH-12.1810  
12mm  
PH-12.1812  
14mm  
PH-12.1814  
16mm  
PH-12.1816  
18mm  
PH-12.1818  
20mm  
PH-12.1820  
22mm  
PH-12.1822  
24mm  
PH-12.1824



Espátula  
200mm

14mm  
PH-12.2014  
18mm  
PH-12.2018  
20mm  
PH-12.2020



Faca Giratória  
Ballenger reta  
200mm

3mm  
PH-53.2003  
4mm  
PH-53.2004  
5mm  
PH-53.2005



Faca Giratória  
Ballenger Baioneta  
200mm

3mm  
PH-53.2007  
4mm  
PH-53.2008  
5mm  
PH-53.2009

## Ganchos para Nervo

Adson 197mm  
profundidade 5mm 0,9mm  
PH-47.1975



Cushing  
190mm

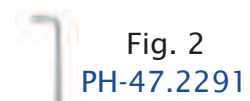
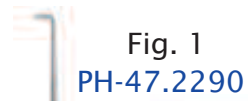

Cushing  
280mm

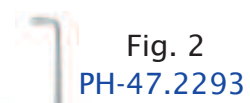
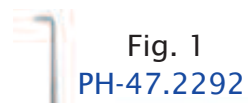

Dandy 219mm  
ponta 3,0x1,5mm  
PH-47.2190



Graham 178mm  
ponta 4,0x1,0mm  
PH-47.1780



Hoer 222mm  
ponta 7,0x1,0mm  
PH-47.2220



Malis 184mm ponta com bola



3mm  
PH-47.1843

Malis 184mm ponta sem bola



3mm  
PH-47.1834

## Ganchos Sonda Ganchos para Nervos



 Cushing  
 140mm ø2mm  
 PH-47.1402

 Frazier  
 127mm ø2mm  
 PH-47.1272

 Lahey 157mm  
 PH-47.1570

 Crile 200mm  
 PH-47.2001

 Gillies 180mm  
 PH-47.1802

Ganchos sonda para exploração  
de raízes nervosas isoladas  
250mm



## Goivas Ósseas Dupla Ação



Cizalha  
Stille-Liston

reta  
230mm  
PH-46.2670

curva  
230mm  
PH-46.2671

angulada 90°  
270mm  
PH-46.2672

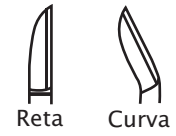
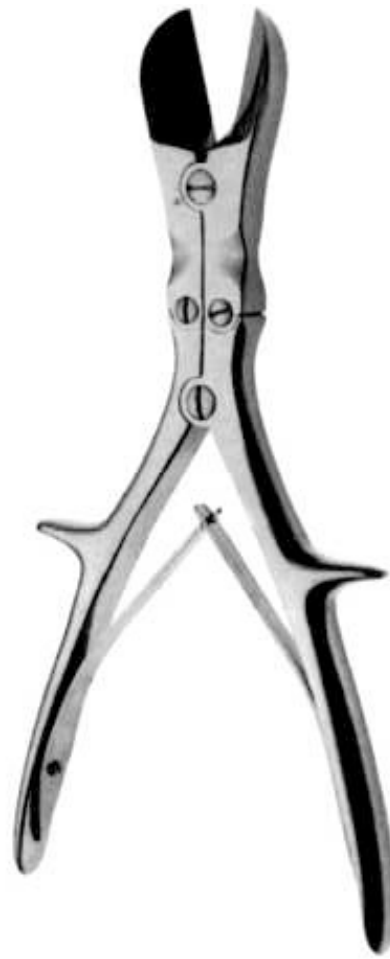

Cizalha  
Liston

reta  
270mm  
PH-46.2700

curva  
230mm  
PH-46.2300



240mm

Cizalha  
Semb  
PH-46.2426



250mm

Cizalha  
Liston-Key  
(Horsley)  
PH-46.2674

## Goivas Ósseas Simples Ação



1/1  boca/mandíbula  
8mm

Adson cranial  
203mm  
PH-46.2038

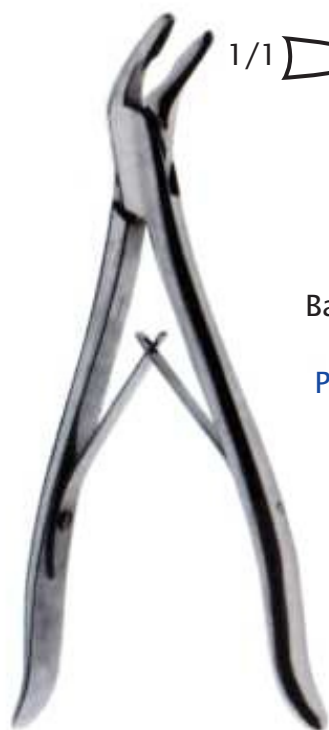

1/1  boca/mandíbula  
5mm

Bacon cranial  
197mm  
PH-46.1975



Sybert  
360mm  
PH-46.3600

## Goivas Ósseas Dupla Ação



Semb  
265mm  
curva  
PH-46.2650

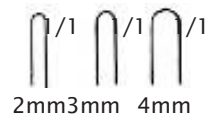

Echlin  
230mm  
angulada  
2mm  
PH-46.2302  
3mm  
PH-46.2303  
4mm  
PH-46.2304



Largura da mandíbula  
mordedura

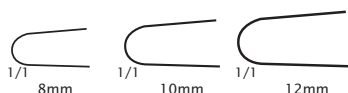

Stille-Luer  
229mm

reta  
8mm  
PH-46.2108  
10mm  
PH-46.2110  
12mm  
PH-46.2112

curva  
8mm  
PH-46.2180  
10mm  
PH-46.2101



Largura da mandíbula  
mordedura

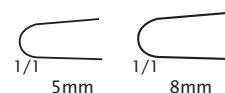

Stille  
229mm

angulada  
5mm  
PH-46.2295  
angulada  
8mm  
PH-46.2298

## Goivas Ósseas Simples Ação



Olivercrona  
200mm  
PH-46.2039

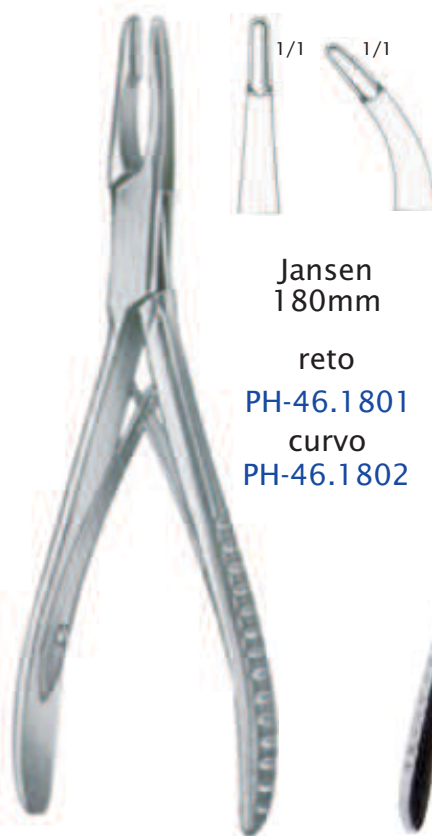

Jansen  
180mm  
reto  
PH-46.1801  
curvo  
PH-46.1802

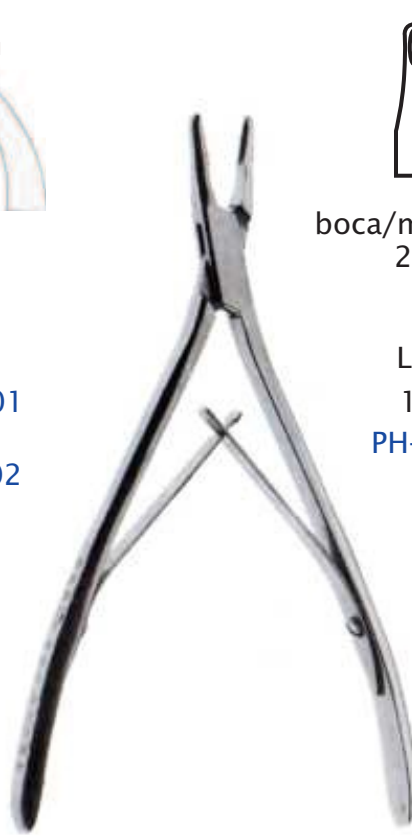

boca/mandíbula  
2mm

Lempert  
156mm  
PH-46.1562



Jansen Baioneta  
180mm  
PH-46.1803



Luer  
170mm  
reto  
PH-46.1701  
curvo  
PH-46.1702



## Goivas Ósseas Dupla Ação



Bohler  
corte/mandíbula 3mm  
150mm



Ruskin  
184mm

Sicard  
225mm  
PH-46.2250





Pinça goiva angular Indian  
corte/mandíbula 4mm  
180mm

PH-46.1510

## Goivas Ósseas Dupla Ação



reta

PH-46.1850



curva

PH-46.1851

Ruskin-Liston  
185mm



curva

PH-46.2329

Stille-Ruskin  
229mm



0<sup>1</sup>/1

Largura da  
mandíbula  
mordedura  
3mm

PH-46.3683

Dale  
280mm

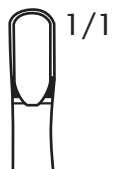

1/1

3mm

PH-46.2330

6mm

PH-46.2340

8mm

PH-46.2380

Leksell  
229mm

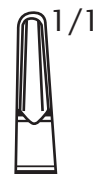

1/1

PH-46.2293

Frykholm  
229mm

## Goivas Ósseas Dupla Ação



Marquardt  
203mm  
curva  
PH-46.2096



Fulton  
242mm



reta  
PH-46.2407



curva acentuada  
PH-46.2409



levemente curva  
PH-46.2408



Smith-Petersen  
240mm



3mm  
PH-46.2403



4mm  
PH-46.2404



5mm  
PH-46.2405



3mm  
PH-46.2430



4mm  
PH-46.2440



5mm  
PH-46.2450



Beyer  
178mm



3mm  
PH-46.1783

## Goivas Ósseas Simples Ação e Dupla Ação



1/1  
Adson  
200mm  
PH-46.2025

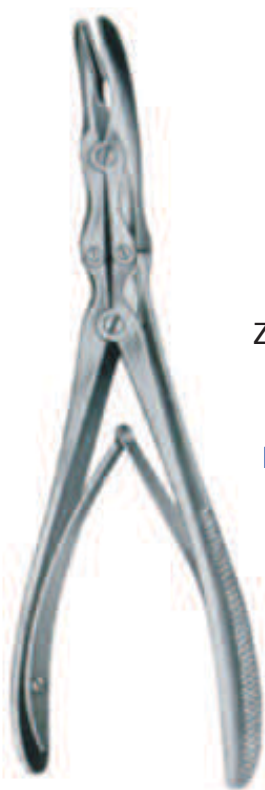

1/1  
4mm  
Zaufal-Jansen  
180mm  
curva  
PH-46.1740

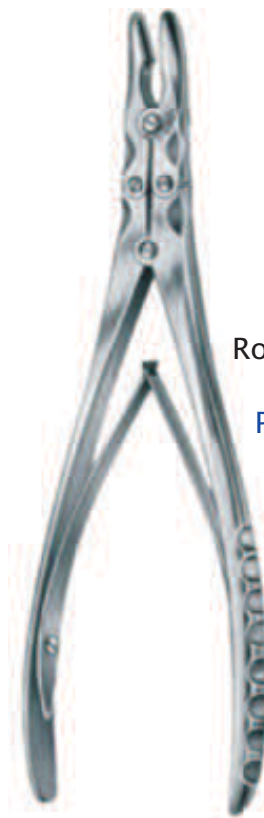

Rottgen-Ruskin  
240mm  
PH-46.2400



Mayfield  
170mm  
PH-46.1735



Kleinert-Kutz  
150mm

1/1  
2mm  
PH-46.1520



1/1  
3mm  
PH-46.1530

abertura regulável  
0,0 à 13,5cm

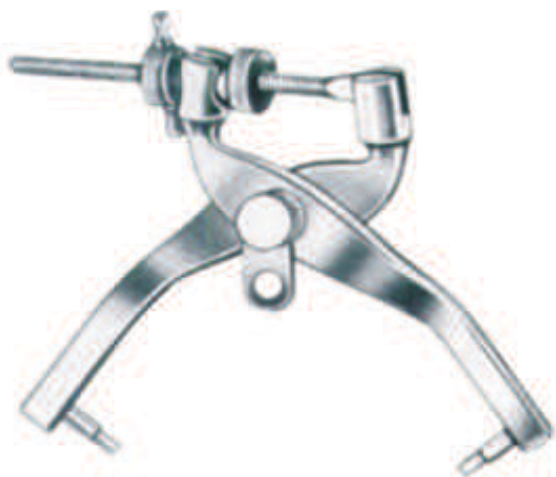

Trator Crutchfield  
pequeno (infantil)  
abertura máxima  
210mm  
PH-48.6270

abertura regulável  
15,0cm



Trator Crutchfield  
médio (adulto)  
abertura máxima  
240mm  
PH-48.6273

### Pontas para Crutchfield

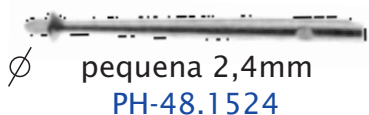

pequena 2,4mm  
PH-48.1524



grande 3mm  
PH-48.1530



Trator Gardner-Wells  
abertura máxima 159mm  
com porcas de ajustes e  
gancho para tração cervical  
PH-48.1590

## Martelos Cirúrgicos

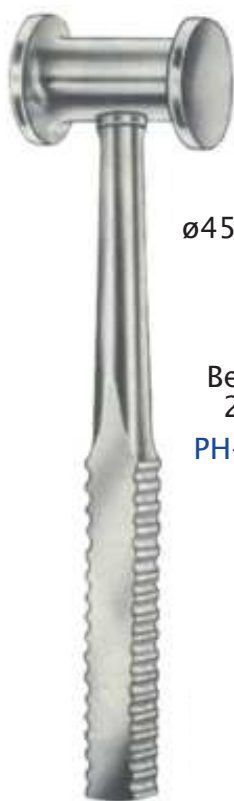

ø45mm

Bergmann  
240mm  
PH-49.2445

ø30mm

ø42mm



Bergmann  
240mm  
30mmx42mm  
PH-49.2430



Ø22mm  
Parsch  
180mm  
PH-49.1822



Lucae  
190mm  
Ø19mm  
PH-49.1919  
Ø25mm  
PH-49.1925

## Martelos Cirúrgicos

Martelo peso leve  
com lado em aço e outro  
revestido em nylon



255mm  
450g  
PH-49.2554  
900g  
PH-49.2559



ø25mm  
18,0cm  
PH-49.1814



320g  
Ø26mm

Mead  
170mm  
PH-49.1726



140g  
Ø27mm

Hajek  
215mm  
PH-49.2127



220g  
Ø30mm

Collin  
200mm  
PH-49.2030



Ø50mm

Martelo Poliacetal  
200mm

PH-49.2020





Conjunto para Osteotomia  
PH-07.4533

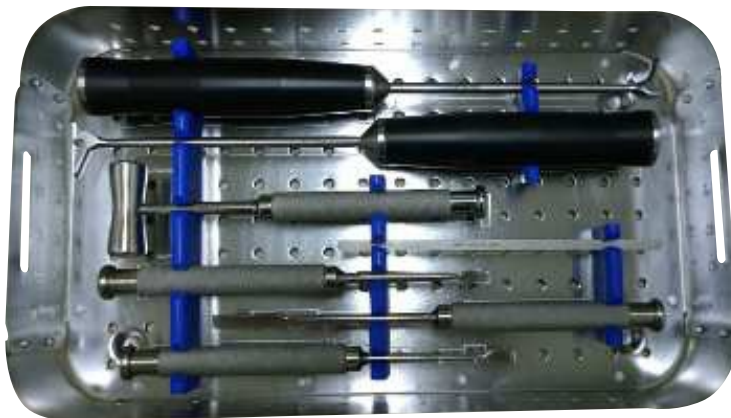

Impactor de muro posterior  
3CO delicado  
PH-07.4528

Impactor de muro  
posterior 3CO  
PH-07.4529

Cinzel de Cloward para  
osteotomia 6,0mm  
PH-46.2406

Espátula para  
osteotomia 6,0mm  
PH-07.4531

Martelo para osteotomia  
PH-07.4530

Cinzel de Cloward para  
osteotomia 8,0mm  
PH-46.2480

Impactor Gutter lateral  
PH-07.4532

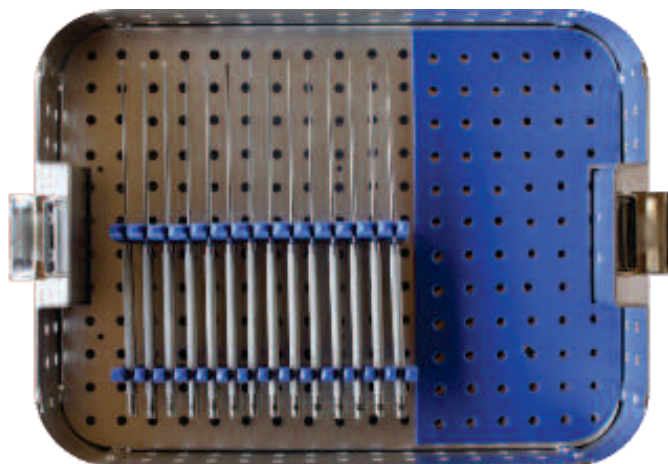

Instrumentos micro cirúrgicos Rhoton-Yasargil  
estojo completo contendo 19 microdissectores

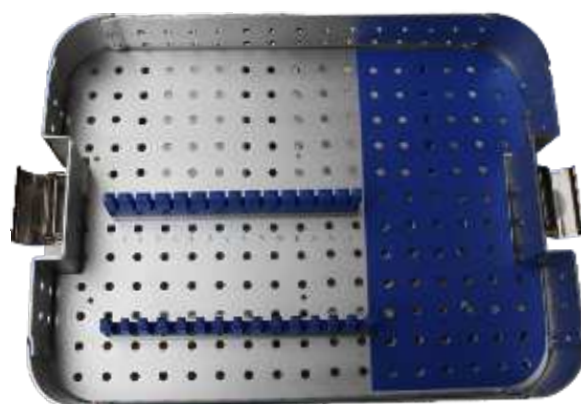

Estojo para microdissectores  
PH-50.1817

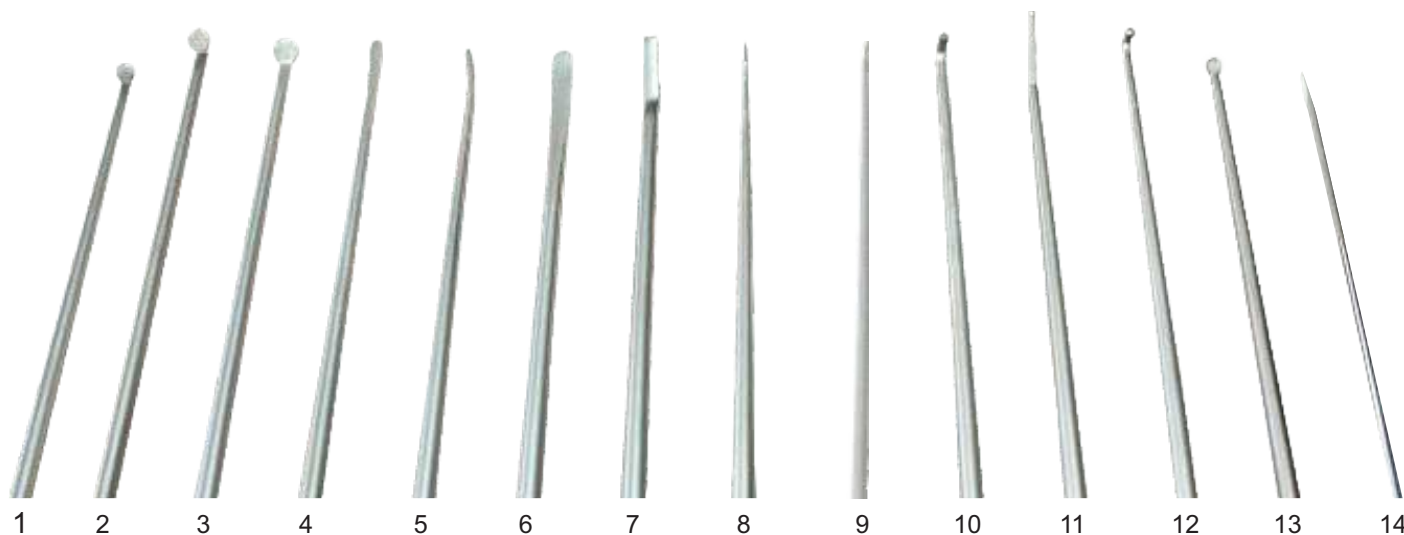

**PH-50.1801** Micro raspador cortante lâmina redonda pequeno 2mm

**PH-50.1802** Micro raspador cortante lâmina redonda médio 2,5mm

**PH-50.1803** Micro raspador cortante lâmina redonda grande 3mm

**PH-50.1804** Micro espátula pequena 1,5mm

**PH-50.1805** Micro espátula média 2,0mm

**PH-50.1806** Micro espátula grande 2,5mm

**PH-50.1807** Micro espátula angulada cortante

**PH-50.1808** Micro ganho afiado/agudo 90°

**PH-50.1809** Micro gancho cego/rombo Angulado 40°

**PH-50.1810** Micro dissector angulado 90° rombo

**PH-50.1811** Micro dissector angulado 40° com bolinha

**PH-50.1812** Micro dissector angulado 90° com bolinha

**PH-50.1813** Micro cureta reta Ø 2.0mm

**PH-50.1814** Micro bisturi reto  
Faquinha para arachnóide

**PH-50.1815** Micro dissector modelo gota reto

**PH-22.2905** Micro Dissector modelo gota angulado 40° 8mm

**PH-22.2901** Micro Dissector modelo gota angulado 90° 3mm

**PH-42.2836** Micro dissector modelo gota angulado 40° 4mm

**PH-42.2835** Micro dissector modelo gota angulado 90° 5mm

## Micro Dissectores Yasargil



PH-50.1801



PH-50.1802



PH-50.1803



PH-50.1804



PH-50.1805



PH-50.1806



PH-50.1807



PH-50.1808



PH-50.1809



PH-50.1810



PH-50.1811



PH-50.1812



PH-50.1813



PH-50.1814



PH-50.1815

(opcional, não incluso no kit de Rhoton)



200mm

1/4



PH-42.2836



PH-22.2901



PH-22.2905



PH-42.2835

## Micro Porta/Porta Agulha com Wídia

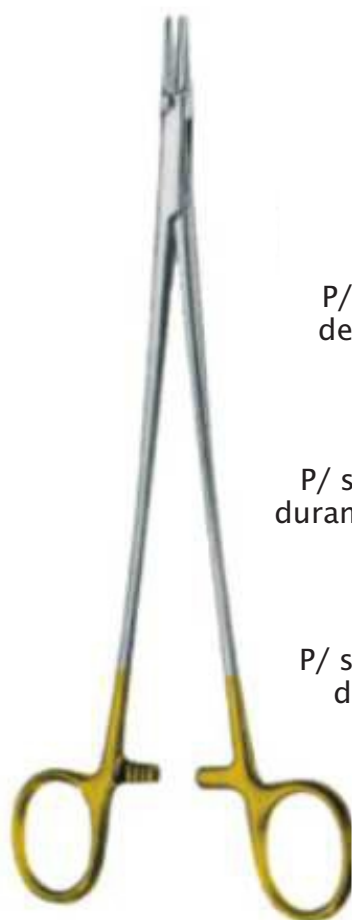

Porta agulha  
com ponta de micro e wídia



P/ suturas delicadas  
de duramater/crânio

160mm  
PH-51.1601

P/ suturas delicadas de  
duramater/medula cervical

180mm  
PH-51.1804

P/ suturas delicadas de  
duramater/lombar

200mm  
PH-51.2000

reto com wídia  
185mm

PH-51.1801

reto sem wídia  
185mm

PH-51.1802

curvo sem wídia  
185mm

PH-51.1803

reto com wídia  
229mm

PH-51.2291

reto sem wídia  
229mm

PH-51.2004

curvo sem wídia  
229mm

PH-51.2293

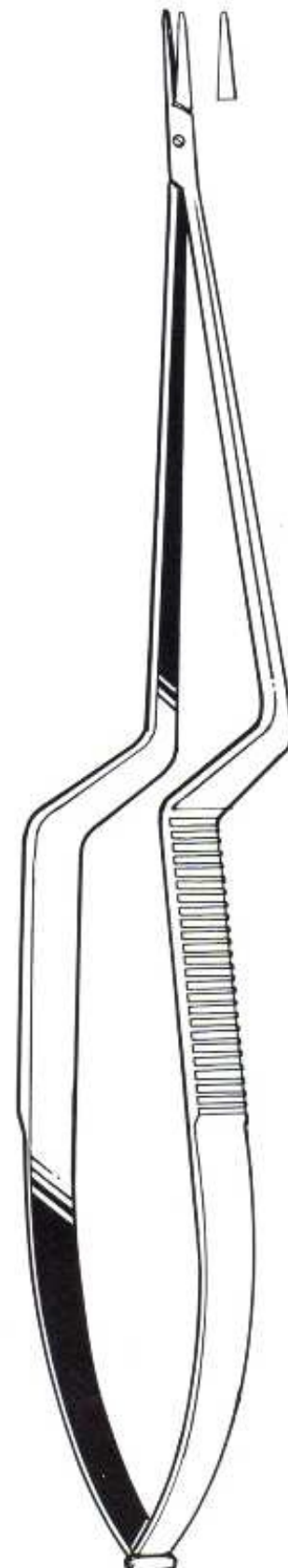

Jacobson em baioneta

## Micro Tesouras em Baioneta



Mallis  
em baioneta curta  
180mm

Lâmina reta  
PH-52.1801

Lâmina suavemente curva  
PH-52.1802



Mallis  
em baioneta média  
200mm

Lâmina reta  
PH-52.2001

Lâmina suavemente curva  
PH-52.2002



Mallis  
em baioneta longa  
220mm

Lâmina reta  
PH-52.2201

Lâmina suavemente curva  
PH-52.2202



Mallis  
em baioneta extra-longa  
240mm

Lâmina reta  
PH-52.2401

Lâmina suavemente curva  
PH-52.2402

## Micro Tesouras em Baioneta



1/1  
Yasargil  
165mm

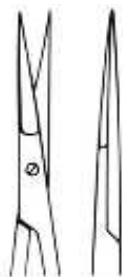

reta  
165mm  
PH-52.1603

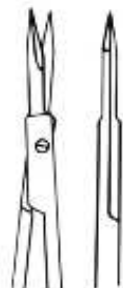

micro ponta  
reta 165mm  
PH-52.1605

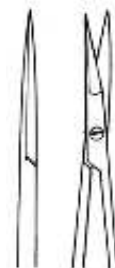

ponta reta fina  
165mm  
PH-52.1606

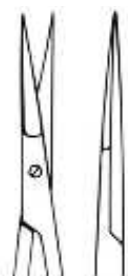

ponta reta  
165mm  
PH-52.1607



ponta curva  
165mm  
PH-52.1608



ponta curva  
fina 165mm  
PH-52.1609



ponta curva  
extra-fina  
165mm  
PH-52.1610

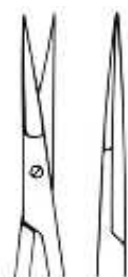

ponta reta  
extra-fina  
165mm  
PH-52.1611

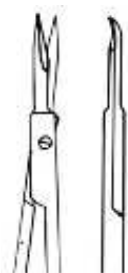

micro ponta  
curva  
165mm  
PH-52.1612



ponta curva  
arredondada  
165mm  
PH-52.1613

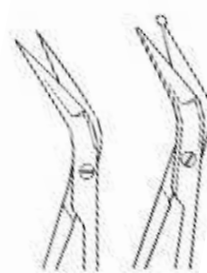

angulada 45°  
165mm  
sem proteção  
PH-52.1614  
com proteção  
PH-52.1615



Yasargil  
180mm

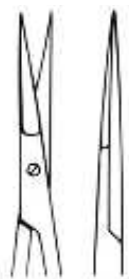

reta  
180mm  
PH-52.0118

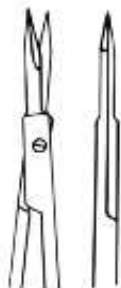

micro ponta  
reta 180mm  
PH-52.1803

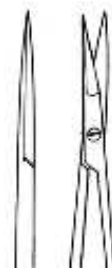

ponta reta fina  
180mm  
PH-52.1804

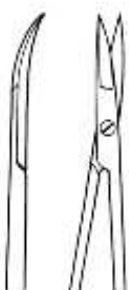

curva  
180mm  
PH-52.0218



ponta curva  
fina  
180mm  
PH-52.1807



ponta curva  
extra-fina  
180mm  
PH-52.1808

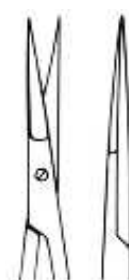

ponta reta  
extra-fina  
180mm  
PH-52.1809



micro ponta  
curva  
180mm  
PH-52.1810



ponta curva  
arredondada  
180mm  
PH-52.1811

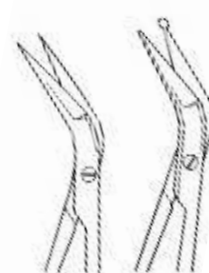

angulada 45°  
180mm  
sem proteção  
PH-52.1812  
com proteção  
PH-52.1813



Yasargil  
200mm

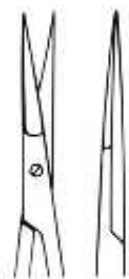

reta  
200mm  
PH-52.2005



micro ponta reta  
200mm  
PH-52.2003

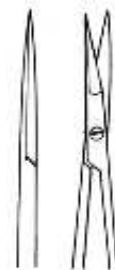

ponta reta fina  
200mm  
PH-52.2004



ponta curva  
200mm  
PH-52.2006



ponta curva fina  
200mm  
PH-52.2007



ponta curva extra fina  
200mm  
PH-52.2008

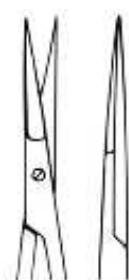

ponta reta  
extra-fina  
200mm  
PH-52.2009

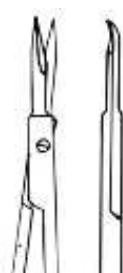

micro ponta  
curva  
200mm  
PH-52.2010



ponta curva  
arredondada  
200mm  
PH-52.2011

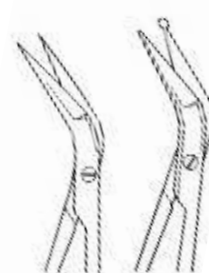

angulada 45°  
200mm  
sem proteção  
PH-52.2012  
com proteção  
PH-52.2013





1/1  
Yasargil  
225mm

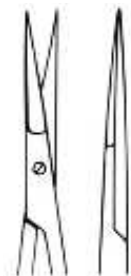

ponta reta  
225mm  
PH-52.2205

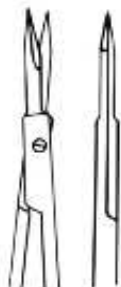

micro ponta reta  
225mm  
PH-52.2203

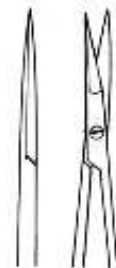

ponta reta fina  
225mm  
PH-52.2204

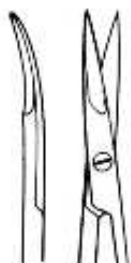

ponta curva  
225mm  
PH-52.2206

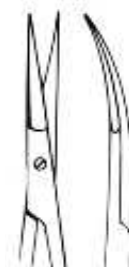

ponta curva fina  
225mm  
PH-52.2207



ponta curva extra fina  
225mm  
PH-52.2208

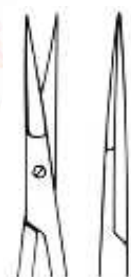

ponta reta  
extra-fina  
225mm  
PH-52.2209

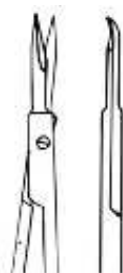

micro ponta  
curva  
225mm  
PH-52.2210



ponta curva  
arredondada  
225mm  
PH-52.2211

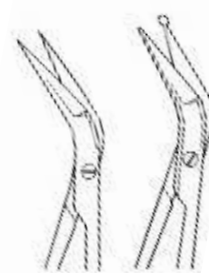

angulada 45°  
sem proteção  
225mm  
PH-52.2212  
com proteção  
225mm  
PH-52.2213

## Micro Tesouras em Baioneta / Reta



Jacobson  
190mm



curva  
PH-52.1901



angulada  
PH-52.1902



reta  
PH-52.1903



micro ponta reta  
PH-52.1904



micro ponta angulada  
PH-52.1905



Jacobson  
180mm



curva  
PH-52.1819



angulada  
PH-52.1820



reta  
PH-52.1821

## Micro Tesoura Retas



Potts-Smith  
reta  
185mm  
PH-52.1851



Potts-Smith  
curva  
185mm  
PH-52.1852



Potts-Smith  
angulada  
185mm  
PH-52.1853



Potts-Smith  
230mm  
PH-52.2300

## Micro Tesouras em Baioneta / Reta

Vannas  
160mm



reta  
PH-52.1616



curva  
PH-52.1617



Vannas  
160mm



micro ponta  
reta  
PH-52.1618



micro ponta  
curva  
PH-52.1619

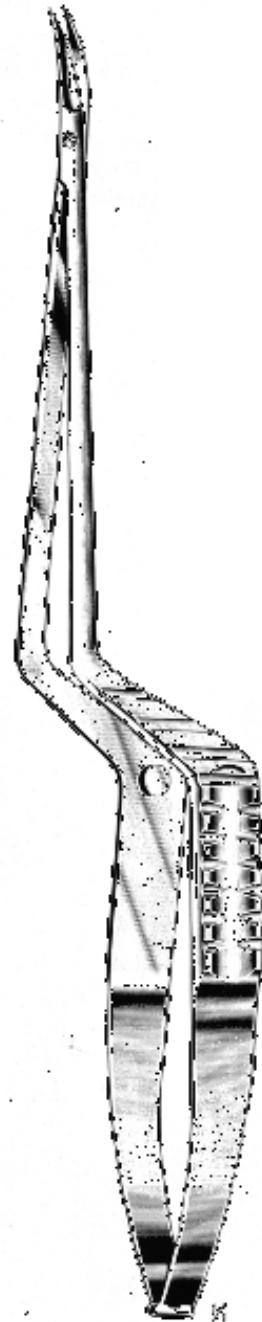

Vannas



reta  
160mm  
PH-52.1620



curva  
160mm  
PH-52.1621



Reta  
180mm  
PH-52.0018



curva  
180mm  
PH-52.0019



Micro tesoura vascular  
60° degree

180mm  
PH-59.0018

200mm  
PH-59.0020

230mm  
PH-59.0023



Micro tesoura vascular  
cuva direita 130° lateral

160mm  
PH-59.0016

185mm  
PH-59.0185

200mm  
PH-59.0120



## Pinça para Tumores



Yasargil  
220mm



3mm  
PH-53.2207



5mm  
PH-53.2208



serrilha  
3mm  
PH-53.2209

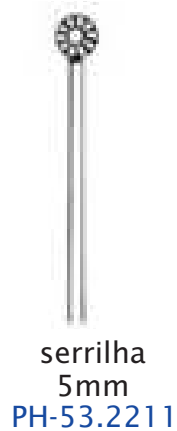

serrilha  
5mm  
PH-53.2211



dente  
3mm  
PH-53.2212



dente  
5mm  
PH-53.2213



Yasargil  
200mm



0.6mm  
PH-54.0600



0.9mm  
PH-54.0900



1x2 dentes micro  
180mm  
PH-54.1800

## Pinça para Tumores



3mm  
PH-53.2201

5mm  
PH-53.2202

7mm  
PH-53.2200

serrilha  
3mm  
PH-53.2203

serrilha  
7mm  
PH-53.2214

dente  
3mm  
PH-53.2204

dente  
5mm  
PH-53.2205

dente  
7mm  
PH-53.2206

Hunt-Yasargil  
220mm



angulada para cima/esquerdo

Ø3mm PH-54.2303    Ø4mm PH-54.2304    Ø5mm PH-54.2305

angulada para baixo/direita

Ø3mm PH-54.2330    Ø4mm PH-54.2340    Ø5mm PH-54.2350

Yasargil Samii  
230mm

## Pinças Micro-Cirúrgicas Delicadas



Yasargil  
185mm



ponta reta  
1,0mm

PH-55.1807



ponta angulada  
0,6mm extra-fina

PH-55.1808



reta  
ponta 1,0mm

PH-55.2290



angulada  
ponta 0,6mm  
Extra-fina

PH-55.2291



Yasargil  
229mm





Lazar reta  
ponta 0,2mm  
110mm  
PH-55.1102



Lazar reta  
ponta 0,15mm  
110mm  
PH-55.1105



Lazar curva  
ponta 0,2mm  
115mm  
PH-55.1152



Lazar reta  
ponta 0,3mm  
125mm  
PH-55.1253



Lazar  
ponta 0,5mm  
155mm  
PH-55.1555



Lazar  
ponta 0,8mm  
155mm  
PH-55.1558



Lazar  
ponta 0,5mm  
185mm  
PH-55.1855



Lazar  
ponta 0,8mm  
185mm  
PH-55.1858

## Pinças Micro-Cirúrgicas Delicadas



Micro-Adson  
serrilhada  
120mm  
PH-55.1201



Adson  
serrilhada  
120mm  
PH-55.1202

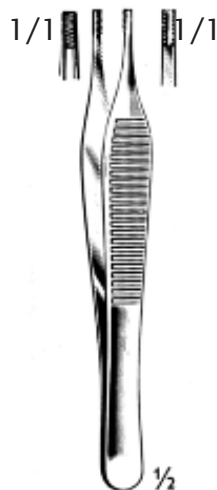

Adson Brown  
9x9 micro dentes  
120mm  
PH-55.1255



Semken  
125mm  
PH-55.1254

150mm  
PH-55.1550

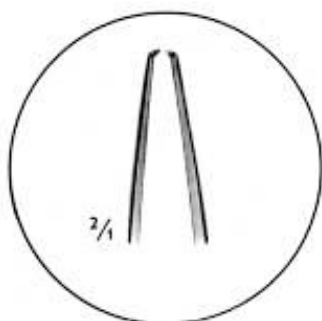

1x2 dentes micro  
120mm  
PH-55.1212

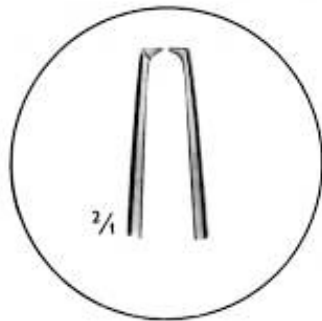

1x2 dentes micro  
150mm  
PH-55.1501

1x2 dentes  
120mm  
PH-55.1213

1x2 dentes  
150mm  
PH-55.1502

1x2 dentes com widia  
120mm  
PH-55.1214

1x2 dentes com widia  
150mm  
PH-55.1503



Semken  
1x2 Dentes  
125mm  
PH-55.1256

1x2 dentes  
150mm  
PH-55.1551



Semken  
2x3 dentes  
125mm  
PH-55.1223

Adson

## Pinças Micro-Cirúrgicas Delicadas



Gerald reta  
serrilhada  
180mm  
PH-55.1801



Gerald curva  
serrilhada  
180mm  
PH-55.1802



Gerald reta  
1x2 dentes  
180mm  
PH-55.1804



Gerald curva  
1x2 dentes  
180mm  
PH-55.1805  
200mm  
PH-55.1811



Taylor curva  
1x2 dentes  
175mm  
PH-55.1750



Potts-Smith  
serrilhada  
180mm  
PH-55.1803



Potts-Smith  
1x2 dentes  
180mm  
PH-55.1806  
200mm  
PH-55.1820



Cushing reto  
1x2 dentes  
180mm  
PH-55.1809



Cushing curva  
1x2 dentes  
180mm  
PH-55.1810



Jansen Gruenwald  
serrilhada  
210mm  
PH-55.2110  
1x2 dentes  
PH-55.2111



Lucae serrilhada  
140mm  
PH-55.1401  
180mm  
PH-55.1800  
210mm  
PH-55.2100

## Pinças para Tumores

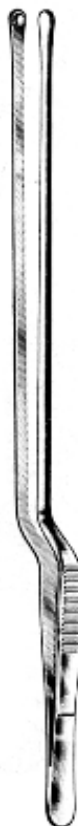

Pinça Adson  
215mm  
PH-53.2150



Pinça Adson  
230mm  
PH-53.2301



Pinça Wilde  
angulada

140mm  
PH-37.1401

180mm  
PH-37.1802



Pinça Jansen  
baioneta

160mm  
PH-37.1616

180mm  
PH-37.1818

200mm  
PH-37.2020

## Pinças para Hérnia de disco Pinças para Remoção de Tecido Mole

Roedores para disco intervertebral



4x8mm



6x10mm



6x12mm

Pinça Love Ferris-Smith  
180mm

4,0mmx8,0mm

PH-56.4080

6,0mmx10mm

PH-56.6010

6,0mmx12mm

PH-56.6012



ø6mm

Pinça Oldberg

178mm

PH-56.1780



### Roedores para disco intervertebral

Pinça Wilde intervertebral reta  
140mm

5,0mm

PH-56.5015

5,5mm

PH-56.5515

6,0mm

PH-56.6015



Pinça Hoen intervertebral  
reta fenestrada  
140mm

4,0mmx12mm

PH-56.4012

## Pinças para Hérnia de disco / Pinças para Remoção de Tecido Mole

### Roedores para disco intervertebral

comprimento eixo/haste

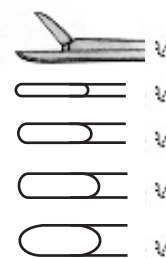

Nome	Medida
Delicate	1x10mm
Cushing	2x10mm
Gruenwald	3x10mm
Spurling	4x10mm
Schlesinger	5x10mm
Cloward	6x10mm



Pinça Love



Largura da boca mandíbula

eixo/haste 140mm

Largura da boca mandíbula

eixo/haste 140mm



1,0mm PH-56.1431  
2,0mm PH-56.1401  
3,0mm PH-56.1402  
4,0mm PH-56.1403  
5,0mm PH-56.1404  
6,0mm PH-56.1405



1,0mm PH-56.1434  
2,0mm PH-56.1416  
3,0mm PH-56.1417  
4,0mm PH-56.1418  
5,0mm PH-56.1419  
6,0mm PH-56.1420



1,0mm PH-56.1432  
2,0mm PH-56.1406  
3,0mm PH-56.1407  
4,0mm PH-56.1408  
5,0mm PH-56.1409  
6,0mm PH-56.1410



1,0mm PH-56.1435  
2,0mm PH-56.1421  
3,0mm PH-56.1422  
4,0mm PH-56.1423  
5,0mm PH-56.1424  
6,0mm PH-56.1425



1,0mm PH-56.1433  
2,0mm PH-56.1411  
3,0mm PH-56.1412  
4,0mm PH-56.1413  
5,0mm PH-56.1414  
6,0mm PH-56.1415



1,0mm PH-56.1436  
2,0mm PH-56.1426  
3,0mm PH-56.1427  
4,0mm PH-56.1428  
5,0mm PH-56.1429  
6,0mm PH-56.1430

## Roedores para disco intervertebral

comprimento eixo/haste

Nome	Medida
Delicate	1x10mm
Cushing	2x10mm
Gruenwald	3x10mm
Spurling	4x10mm
Schlesinger	5x10mm
Cloward	6x10mm

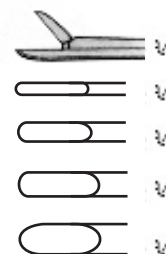

Pinça Love



Largura da boca mandíbula eixo/haste 155mm

Largura da boca mandíbula eixo/haste 155mm



- 1,0mm PH-44.1581
- 2,0mm PH-44.1551
- 3,0mm PH-44.1552
- 4,0mm PH-44.1553
- 5,0mm PH-44.1554
- 6,0mm PH-44.1555



- 1,0mm PH-44.1584
- 2,0mm PH-44.1566
- 3,0mm PH-44.1567
- 4,0mm PH-44.1568
- 5,0mm PH-44.1569
- 6,0mm PH-44.1570



- 1,0mm PH-44.1582
- 2,0mm PH-44.1556
- 3,0mm PH-44.1557
- 4,0mm PH-44.1558
- 5,0mm PH-44.1559
- 6,0mm PH-44.1560



- 1,0mm PH-44.1585
- 2,0mm PH-44.1571
- 3,0mm PH-44.1572
- 4,0mm PH-44.1573
- 5,0mm PH-44.1574
- 6,0mm PH-44.1575



- 1,0mm PH-44.1583
- 2,0mm PH-44.1561
- 3,0mm PH-44.1562
- 4,0mm PH-44.1563
- 5,0mm PH-44.1564
- 6,0mm PH-44.1565



- 1,0mm PH-44.1586
- 2,0mm PH-44.1576
- 3,0mm PH-44.1577
- 4,0mm PH-44.1578
- 5,0mm PH-44.1579
- 6,0mm PH-44.1580



## Pinças para Hérnia de disco / Pinças para Remoção de Tecido Mole

### Roedores para disco intervertebral

comprimento eixo/haste

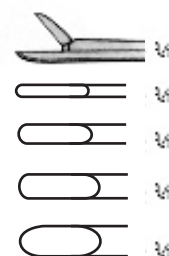

Nome	Medida
Delicate	1x10mm
Cushing	2x10mm
Gruenwald	3x10mm
Spurling	4x10mm
Schlesinger	5x10mm
Cloward	6x10mm



Pinça Love



Largura da boca mandíbula eixo/haste 178mm



Largura da boca mandíbula eixo/haste 178mm

	1,0mm	PH-56.1731
	2,0mm	PH-56.1701
	3,0mm	PH-56.1702
	4,0mm	PH-56.1703
	5,0mm	PH-56.1704
	6,0mm	PH-56.1705

	1,0mm	PH-56.1734
	2,0mm	PH-56.1716
	3,0mm	PH-56.1717
	4,0mm	PH-56.1718
	5,0mm	PH-56.1719
	6,0mm	PH-56.1720

	1,0mm	PH-56.1732
	2,0mm	PH-56.1706
	3,0mm	PH-56.1707
	4,0mm	PH-56.1708
	5,0mm	PH-56.1709
	6,0mm	PH-56.1710

	1,0mm	PH-56.1735
	2,0mm	PH-56.1721
	3,0mm	PH-56.1722
	4,0mm	PH-56.1723
	5,0mm	PH-56.1724
	6,0mm	PH-56.1725

	1,0mm	PH-56.1733
	2,0mm	PH-56.1711
	3,0mm	PH-56.1712
	4,0mm	PH-56.1713
	5,0mm	PH-56.1714
	6,0mm	PH-56.1715

	1,0mm	PH-56.1736
	2,0mm	PH-56.1726
	3,0mm	PH-56.1727
	4,0mm	PH-56.1728
	5,0mm	PH-56.1729
	6,0mm	PH-56.1730

## Roedores para disco intervertebral

comprimento eixo/haste

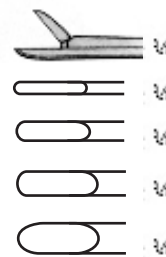

Nome	Medida
Delicate	1x10mm
Cushing	2x10mm
Gruenwald	3x10mm
Spurling	4x10mm
Schlesinger	5x10mm
Cloward	6x10mm



Pinça Love



Largura da boca mandíbula eixo/haste 203mm



Largura da boca mandíbula eixo/haste 203mm



- 1,0mm PH-56.2061
- 2,0mm PH-56.2031
- 3,0mm PH-56.2032
- 4,0mm PH-56.2033
- 5,0mm PH-56.2034
- 6,0mm PH-56.2035



- 1,0mm PH-56.2064
- 2,0mm PH-56.2046
- 3,0mm PH-56.2047
- 4,0mm PH-56.2048
- 5,0mm PH-56.2049
- 6,0mm PH-56.2050



- 1,0mm PH-56.2062
- 2,0mm PH-56.2036
- 3,0mm PH-56.2037
- 4,0mm PH-56.2038
- 5,0mm PH-56.2039
- 6,0mm PH-56.2040



- 1,0mm PH-56.2065
- 2,0mm PH-56.2051
- 3,0mm PH-56.2052
- 4,0mm PH-56.2053
- 5,0mm PH-56.2054
- 6,0mm PH-56.2055



- 1,0mm PH-56.2063
- 2,0mm PH-56.2041
- 3,0mm PH-56.2042
- 4,0mm PH-56.2043
- 5,0mm PH-56.2044
- 6,0mm PH-56.2045



- 1,0mm PH-56.2066
- 2,0mm PH-56.2056
- 3,0mm PH-56.2057
- 4,0mm PH-56.2058
- 5,0mm PH-56.2059
- 6,0mm PH-56.2060

## Pinças para Hérnia de disco / Pinças para Remoção de Tecido Mole

### Roedores para disco intervertebral

comprimento  
eixo/haste

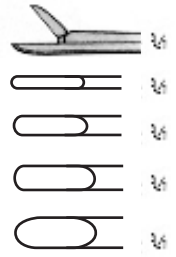

Nome	Medida
Delicate	1x10mm
Cushing	2x10mm
Gruenwald	3x10mm
Spurling	4x10mm
Schlesinger	5x10mm
Cloward	6x10mm



Pinça Love



mandíbula 229mm



mandíbula 229mm



- 1,0mm PH-56.2295
- 2,0mm PH-56.1801
- 3,0mm PH-56.1802
- 4,0mm PH-56.1803
- 5,0mm PH-56.1804
- 6,0mm PH-56.1805



- 1,0mm PH-56.2298
- 2,0mm PH-56.2280
- 3,0mm PH-56.2281
- 4,0mm PH-56.2282
- 5,0mm PH-56.2283
- 6,0mm PH-56.2284



- 1,0mm PH-56.2296
- 2,0mm PH-56.1806
- 3,0mm PH-56.1807
- 4,0mm PH-56.1808
- 5,0mm PH-56.1809
- 6,0mm PH-56.1810



- 1,0mm PH-56.2299
- 2,0mm PH-56.2285
- 3,0mm PH-56.2286
- 4,0mm PH-56.2287
- 5,0mm PH-56.2288
- 6,0mm PH-56.2289



- 1,0mm PH-56.2297
- 2,0mm PH-56.1811
- 3,0mm PH-56.1812
- 4,0mm PH-56.1813
- 5,0mm PH-56.1814
- 6,0mm PH-56.1815



- 1,0mm PH-56.2300
- 2,0mm PH-56.2290
- 3,0mm PH-56.2291
- 4,0mm PH-56.2292
- 5,0mm PH-56.2293
- 6,0mm PH-56.2294

## Roedores para disco intervertebral tamanhos especiais

comprimento  
eixo/haste

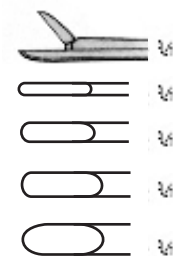

Nome	Medida
Delicate	1x10mm
Cushing	2x10mm
Gruenwald	3x10mm
Spurling	4x10mm
Schlesinger	5x10mm
Cloward	6x10mm



Largura da boca  
mandíbula eixo/haste  
279mm

Largura da boca  
mandíbula eixo/haste  
279mm



2,0mm PH-56.2785  
3,0mm PH-56.2786  
4,0mm PH-56.2787  
5,0mm PH-56.2788  
6,0mm PH-56.2789



2,0mm PH-56.2710  
3,0mm PH-56.2711  
4,0mm PH-56.2712  
5,0mm PH-56.2713  
6,0mm PH-56.2714



2,0mm PH-56.2790  
3,0mm PH-56.2791  
4,0mm PH-56.2792  
5,0mm PH-56.2793  
6,0mm PH-56.2794



2,0mm PH-56.2715  
3,0mm PH-56.2716  
4,0mm PH-56.2717  
5,0mm PH-56.2718  
6,0mm PH-56.2719



2,0mm PH-56.2795  
3,0mm PH-56.2796  
4,0mm PH-56.2797  
5,0mm PH-56.2798  
6,0mm PH-56.2799



2,0mm PH-56.2720  
3,0mm PH-56.2721  
4,0mm PH-56.2722  
5,0mm PH-56.2723  
6,0mm PH-56.2724

## Pinças para Hérnia de disco / Pinças para Remoção de Tecido Mole

Roedores para disco intervertebral  
tamanhos especiais

comprimento  
eixo/haste

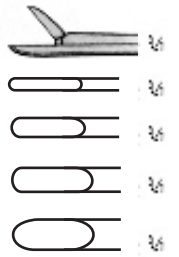

Nome	Medida
Delicate	1x10mm
Cushing	2x10mm
Gruenwald	3x10mm
Spurling	4x10mm
Schlesinger	5x10mm
Cloward	6x10mm



Pinça Love



Largura da boca mandíbula	eixo/haste
2,0mm	305mm
3,0mm	PH-56.3050
4,0mm	PH-56.3051
5,0mm	PH-56.3052
6,0mm	PH-56.3053
	PH-56.3054



Largura da boca mandíbula	eixo/haste
2,0mm	305mm
3,0mm	PH-56.3010
4,0mm	PH-56.3011
5,0mm	PH-56.3012
6,0mm	PH-56.3013
	PH-56.3014



2,0mm	PH-56.3055
3,0mm	PH-56.3056
4,0mm	PH-56.3057
5,0mm	PH-56.3058
6,0mm	PH-56.3059



2,0mm	PH-56.3015
3,0mm	PH-56.3016
4,0mm	PH-56.3017
5,0mm	PH-56.3018
6,0mm	PH-56.3019



2,0mm	PH-56.3060
3,0mm	PH-56.3061
4,0mm	PH-56.3062
5,0mm	PH-56.3063
6,0mm	PH-56.3064



2,0mm	PH-56.3020
3,0mm	PH-56.3021
4,0mm	PH-56.3022
5,0mm	PH-56.3023
6,0mm	PH-56.3024

## Passador de Cateter



Neonatal  
315mm  
PH-41.3150

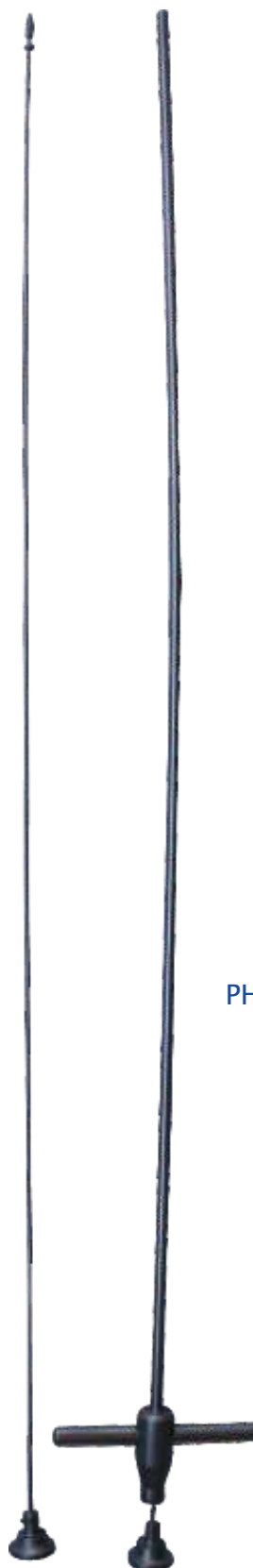

Infantil  
400mm  
PH-41.3140

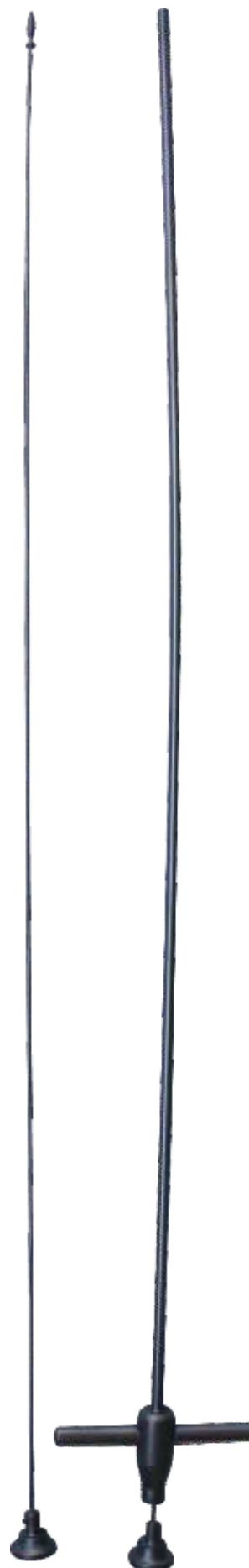

Adulto  
60,0cm  
PH-41.3160  
65,0cm  
PH-14.0617  
70,0cm  
PH-14.0618  
80,0cm  
PH-14.0446  
90,0cm  
PH-14.0447

## Pinças para Laminectomia Pinça Kerrison

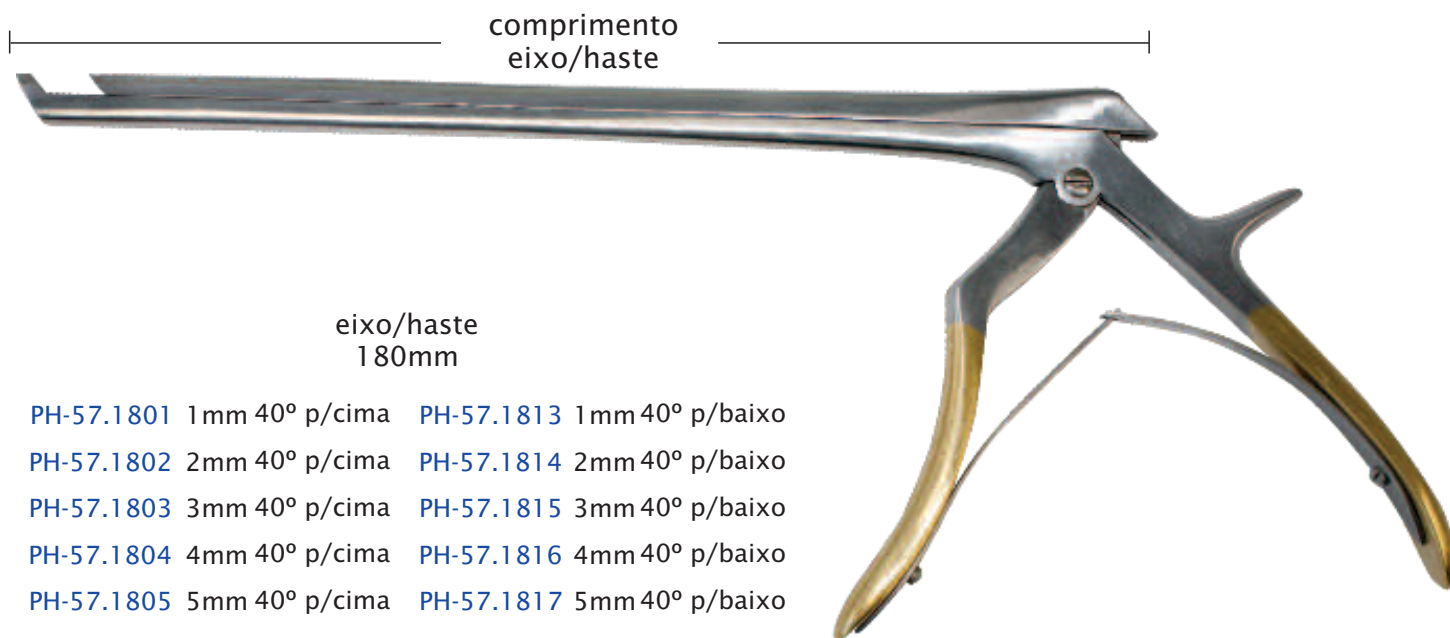

eixo/haste  
180mm

- |                           |                            |
|---------------------------|----------------------------|
| PH-57.1801 1mm 40° p/cima | PH-57.1813 1mm 40° p/baixo |
| PH-57.1802 2mm 40° p/cima | PH-57.1814 2mm 40° p/baixo |
| PH-57.1803 3mm 40° p/cima | PH-57.1815 3mm 40° p/baixo |
| PH-57.1804 4mm 40° p/cima | PH-57.1816 4mm 40° p/baixo |
| PH-57.1805 5mm 40° p/cima | PH-57.1817 5mm 40° p/baixo |

- |                           |                            |
|---------------------------|----------------------------|
| PH-57.1807 1mm 90° p/cima | PH-57.1819 1mm 90° p/baixo |
| PH-57.1808 2mm 90° p/cima | PH-57.1820 2mm 90° p/baixo |
| PH-57.1809 3mm 90° p/cima | PH-57.1821 3mm 90° p/baixo |
| PH-57.1810 4mm 90° p/cima | PH-57.1822 4mm 90° p/baixo |
| PH-57.1811 5mm 90° p/cima | PH-57.1823 5mm 90° p/baixo |

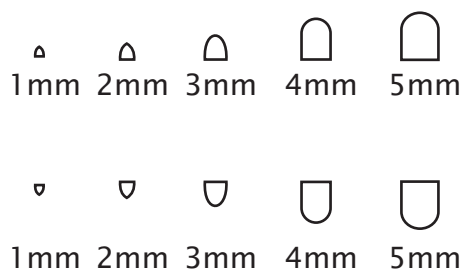

eixo/haste  
203mm

- |                           |                            |                           |                            |
|---------------------------|----------------------------|---------------------------|----------------------------|
| PH-57.2001 1mm 40° p/cima | PH-57.2013 1mm 40° p/baixo | PH-57.2301 1mm 40° p/cima | PH-57.2313 1mm 40° p/baixo |
| PH-57.2002 2mm 40° p/cima | PH-57.2014 2mm 40° p/baixo | PH-57.2302 2mm 40° p/cima | PH-57.2314 2mm 40° p/baixo |
| PH-57.2003 3mm 40° p/cima | PH-57.2015 3mm 40° p/baixo | PH-57.2303 3mm 40° p/cima | PH-57.2315 3mm 40° p/baixo |
| PH-57.2004 4mm 40° p/cima | PH-57.2016 4mm 40° p/baixo | PH-57.2304 4mm 40° p/cima | PH-57.2316 4mm 40° p/baixo |
| PH-57.2005 5mm 40° p/cima | PH-57.2017 5mm 40° p/baixo | PH-57.2305 5mm 40° p/cima | PH-57.2317 5mm 40° p/baixo |
| PH-57.2006 6mm 40° p/cima | PH-57.2018 6mm 40° p/baixo | PH-57.2306 6mm 40° p/cima | PH-57.2318 6mm 40° p/baixo |
| PH-57.2007 1mm 90° p/cima | PH-57.2019 1mm 90° p/baixo | PH-57.2307 1mm 90° p/cima | PH-57.2319 1mm 90° p/baixo |
| PH-57.2008 2mm 90° p/cima | PH-57.2020 2mm 90° p/baixo | PH-57.2308 2mm 90° p/cima | PH-57.2320 2mm 90° p/baixo |
| PH-57.2009 3mm 90° p/cima | PH-57.2021 3mm 90° p/baixo | PH-57.2309 3mm 90° p/cima | PH-57.2321 3mm 90° p/baixo |
| PH-57.2010 4mm 90° p/cima | PH-57.2022 4mm 90° p/baixo | PH-57.2310 4mm 90° p/cima | PH-57.2322 4mm 90° p/baixo |
| PH-57.2011 5mm 90° p/cima | PH-57.2023 5mm 90° p/baixo | PH-57.2311 5mm 90° p/cima | PH-57.2323 5mm 90° p/baixo |

eixo/haste  
230mm

## Pinças para Laminectomia Pinça Kerrison

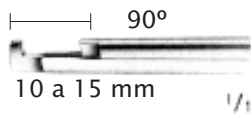

- 90° p/cima
- 1mm
- PH-57.1825
- 2mm
- PH-57.1826
- 3mm
- PH-57.1827
- 4mm
- PH-57.1828
- 5mm
- PH-57.1829

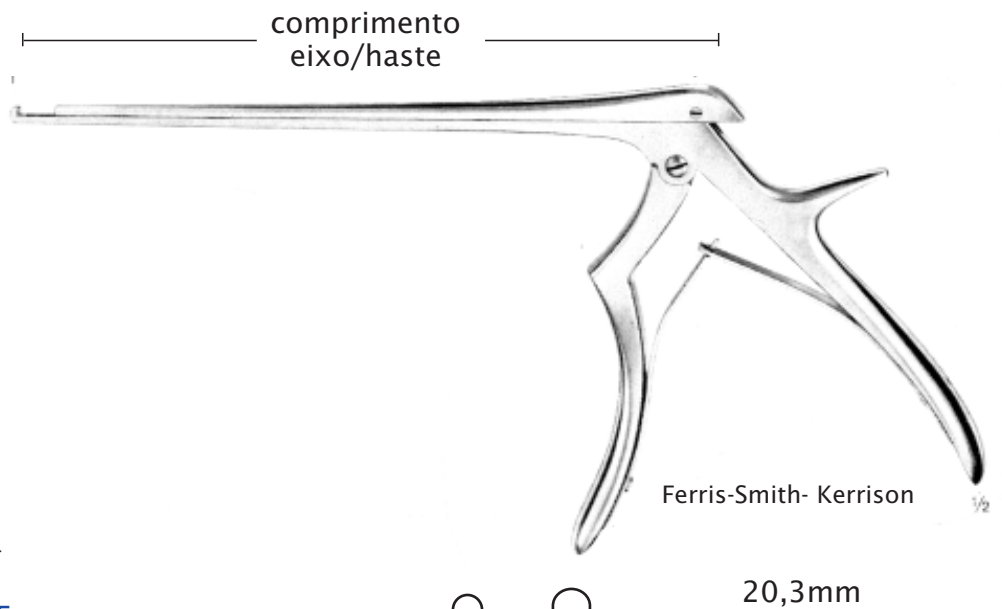
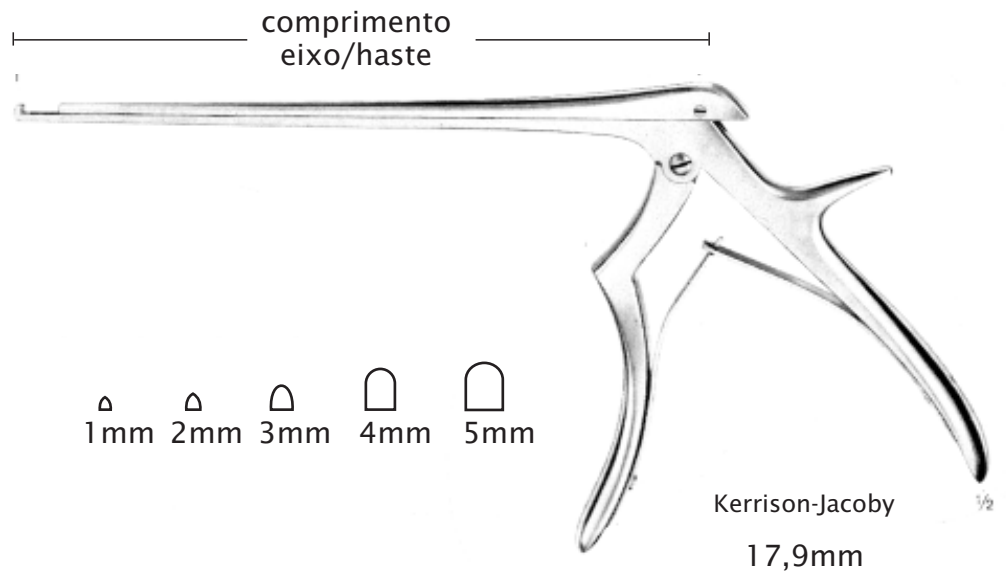

- |            |            |
|------------|------------|
| 40° p/cima | 90° p/cima |
| 1mm        | 1mm        |
| PH-57.1830 | PH-57.1835 |
| 2mm        | 2mm        |
| PH-57.1831 | PH-57.1836 |
| 3mm        | 3mm        |
| PH-57.1832 | PH-57.1837 |
| 4mm        | 4mm        |
| PH-57.1833 | PH-57.1838 |
| 5mm        | 5mm        |
| PH-57.1834 | PH-57.1839 |

- |     |     |     |     |     |
|-----|-----|-----|-----|-----|
| 1mm | 2mm | 3mm | 4mm | 5mm |
| 1mm | 2mm | 3mm | 4mm | 5mm |



Tamanhos especiais

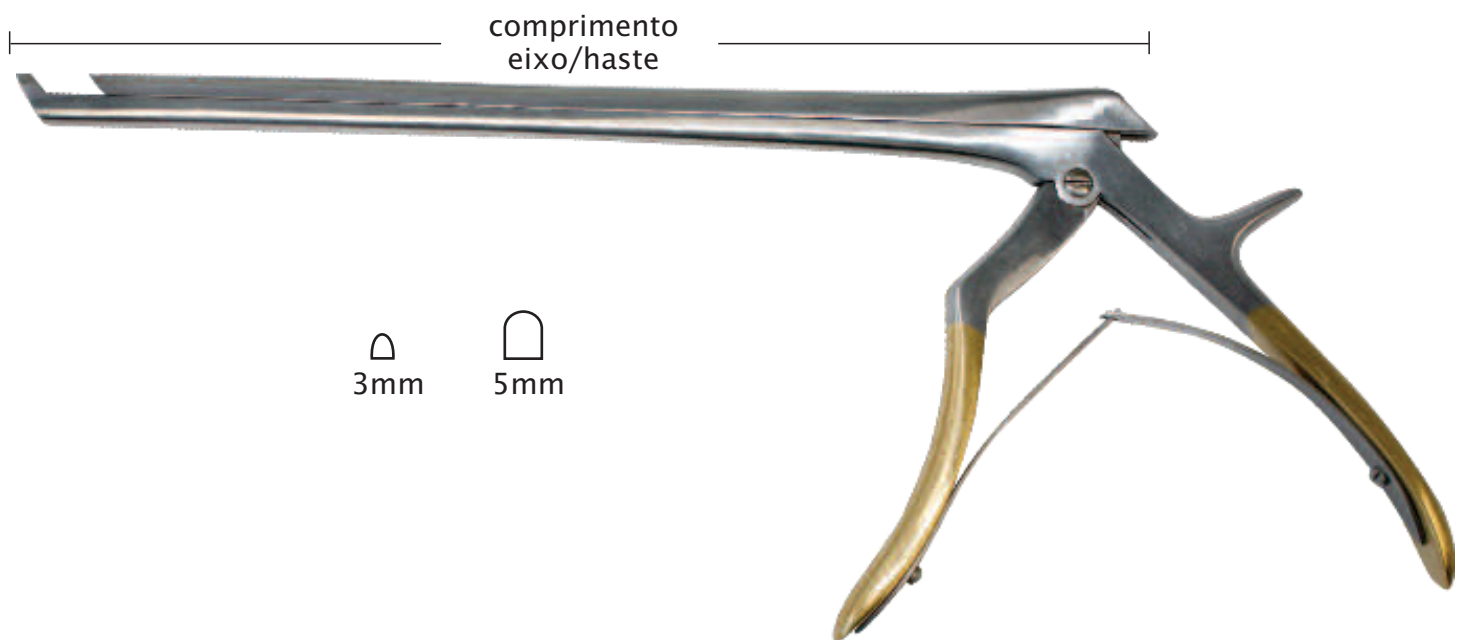

comprimento  
eixo/haste

3mm

5mm

eixo/haste  
279mm

PH-57.2703 3mm 40° p/cima

PH-57.2705 5mm 40° p/cima

eixo/haste  
300mm

PH-57.3003 3mm 40° p/cima

PH-57.3005 5mm 40° p/cima

## Pinça para Laminectomia Saca Bocados



2mm  
PH-57.1840

3mm  
PH-57.1841

4mm  
PH-57.1842

5mm  
PH-57.1843

Kerrison-Black  
sistema de desmontagem para  
facilitação de limpeza  
180mm



1mm  
PH-62.1821

2mm  
PH-62.1822

3mm  
PH-62.1823

4mm  
PH-62.1824

5mm  
PH-62.1825

Kerrison para cima 180mm

## Tesouras Neuro Cirúrgicas



Tesoura Frazier  
para duramater  
170mm  
PH-58.1710



Tesoura Strully  
para duramater  
203mm  
PH-58.2030



Tesoura Taylor  
para duramater  
146mm  
PH-58.1460

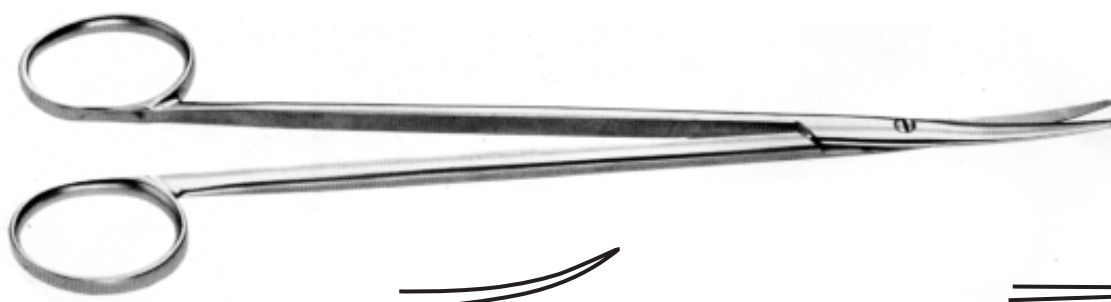

Tesoura  
Metzenbaum

curva  
200mm  
PH-58.2000

curva  
180mm  
PH-58.1801

reta  
200mm  
PH-58.2001

reta  
180mm  
PH-58.1800

## Rugina / Descolador de Periósteo Elevadores Duramater

PH-44.2110 10mm

PH-44.2115 15mm

PH-44.2120 20mm

PH-44.2125 25mm

PH-44.1945 5,0mm

PH-44.1918 17,0mm

PH-44.2066 6,0mm

PH-44.1835 3,5mm

PH-44.2003 3,5mm

PH-44.1740 4,0mm

PH-44.2305 5,0mm

PH-44.2067

PH-44.2150



Lambotte  
210mm



Cushing  
194mm



Langenbeck  
191mm



Langenbeck estreito  
206mm



Elevador Malis titânio reto  
184mm



Elevador Malis titânio baioneta  
203mm



Presbyterian  
178mm



2,0cm

2,0cm 1/1



Cohen  
230mm



Elevador de duramater  
tipo Fujita  
200mm



Elevador de duramater  
tipo Fujita  
215mm

## Trefina para Biópsia e Trocater



Trefina de biópsia óssea  
com trocater  
tipo cureta 165mm  
Ø10,0mm

PH-61.1602

Ø8,0mm

PH-61.1601



Instrumental ideal para  
coleta óssea de biópsia coluna.

PH-14.0619



Trocater com mandril  
ponta aguda ø4mm  
130mm

PH-61.1300

## Cadeira para Neurocirurgia

---



Cadeira para  
cirurgião  
PH-80.0001





- Desenvolvido em modernos parâmetros para cirurgia de coluna
- Radiopaco em 360°, permitindo raio-X em AP/Perfil Oblíquo
- Ajustes laterais para liberar o abdômem, evitando compressões através da regulação manual.
- Compatível com RX/TC, arco cirúrgico.
- Preciso, de fácil manejo e transporte.

PHR-5000

## Halo Vest



pequeno  
PH-75.6650

médio  
PH-75.6655

grande  
PH-75.6660



espátula  
PH-75.6665



chave  
PH-75.6670

Indicado nos traumatismos e imobilização da coluna cervical e torácica. Ajustável ao tamanho do paciente e confeccionado em alumínio revestido em teflon, fecho velcro, polipropileno, titânio e forrado com pele de ovinho gerando mais segurança e conforto ao paciente.



## Curetas Especiais / Via Lateral Cirurgia Tóraco Lombar Transforaminal



curva 35°  
R. 30mm  
ø 9,5 mm

cureta  
concha curva  
lateral à direita  
335mm

**PH-39.3095**



cureta  
concha curva  
lateral à esquerda  
335mm

**PH-39.3096**



cureta vista  
costas e frente



cureta vista  
costas



7 dentes cortantes  
curva 35°  
R. 30mm  
ø 8,5 mm

cureta  
concha dentada  
lateral à direita  
335mm

**PH-39.3085**



cureta  
concha dentada  
lateral à esquerda  
335mm

**PH-39.3086**



curva lateral  
esquerda  
9,5x18mm

Cureta Scoville extra longa  
para ruptura de disco  
curva lateral direita  
335mm  
PH-31.3350



curva lateral  
direita  
9,5x18mm

Cureta Scoville extra longa  
para ruptura de disco  
curva lateral esquerda  
335mm  
PH-31.3351



1/1



reta  
5,0x7,5mm  
PH-31.5370



ângulo reverso  
5,0x7,5mm  
PH-31.5375



angulada  
5,0x7,5mm  
PH-31.5380

Cureta Scoville  
para ruptura de disco  
254mm



230mm

**PH-43.2345**  
Dissector reto  
ponta curva  
4,5mm

**PH-43.2346**  
Dissector  
em baioneta  
curvo p/baixo  
4,5mm

**PH-43.2320**  
Dissector  
em baioneta  
curvo p/baixo  
2mm

**PH-43.2321**  
Impulsor  
para  
sutura

**PH-43.2010**  
Micro dissector  
reto ponta curva  
1mm

210mm  
**PH-43.2011**  
Micro dissector  
em baioneta  
curvo p/ cima  
1mm

**PH-43.2012**  
Micro dissector  
em baioneta  
curvo p/ baixo  
1mm







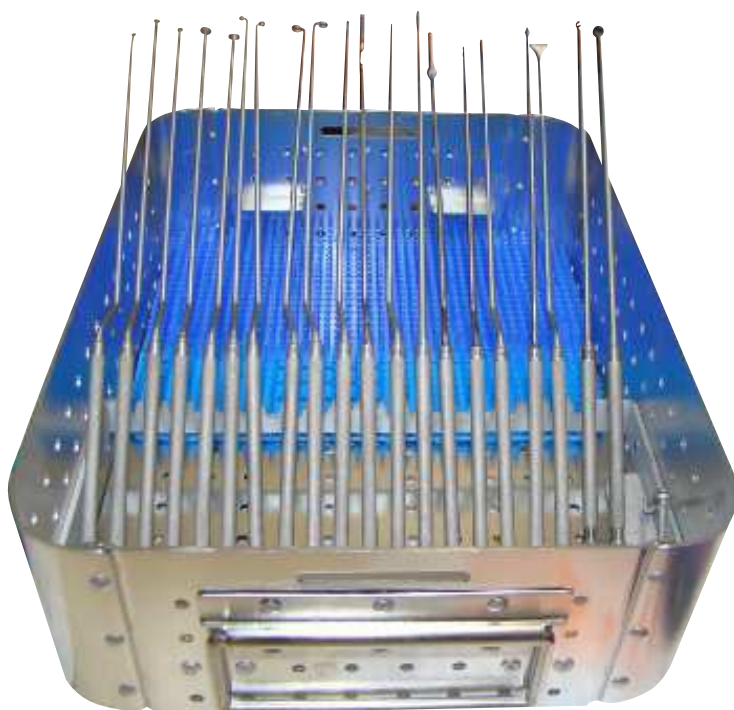



Somente estojo  
PH-58.2499

Estojo completo contendo  
20 instrumentos cirúrgicos  
via endoscopia hipófise



Instrumentais para  
cirurgia endoscópica  
vide próximas páginas

- PH-14.0818 Micro cureta em baioneta 250,0mm ponta 90° para cima com corte  
ø externo 3,0mm interno 2,5mm
- PH-14.0819 Micro cureta em baioneta 250mm ponta 45° para cima com corte  
ø externo 3,0mm interno 2,5mm
- PH-14.0820 Cureta de aspiracao 250mm ponta 45° com fio redondo e corte  
ø externo 5,0 interno 2,5mm
- PH-58.2516 Cureta de aspiracao 250mm ponta 45° com fio redondo e corte  
ø externo 3,0 interno 2,5mm
- PH-58.2517 Micro cureta em baioneta com corte, ponta em ângulo lateral direito,  
250mm ø Externo 3,0mm, Interno 2,5mm.
- PH-58.2518 Micro cureta em baioneta com corte, ponta em ângulo lateral esquerdo,  
250mm ø Externo 3,0mm, Interno 2,5mm.
- PH-58.2519 Micro cureta em baioneta com corte, ponta em ângulo de 40°  
250mm ø Externo 2,3mm, Interno 2,0mm.
- PH-58.2520 Micro cureta em baioneta com corte, ponta em ângulo de 90° p/ cima  
250mm ø Externo 5,0mm, Interno 4,0mm.
- PH-58.2521 Micro cureta em baioneta com corte, ponta em ângulo lateral esquerdo,  
250mm ø Externo 5,0mm, Interno 4,0mm.
- PH-58.2522 Micro cureta em baioneta com corte, ponta em ângulo lateral direito,  
250mm ø Externo 5,0mm, Interno 4,0mm.
- PH-58.2523 Micro cureta em baioneta com corte, ponta em ângulo de 40°  
250mm ø Externo 5,0mm, Interno 4,0mm.
- PH-58.2524 Micro espátula baioneta ponta reta 1,5mm | 250mm
- PH-58.2525 Medidor de ouvido em baioneta 250mm
- PH-58.2526 Micro dissector em baioneta ponta angulada 90° rombo 250mm
- PH-58.2527 Micro espátula em baioneta ponta curva para cima 1,5mm 250mm
- PH-58.2528 Micro bisturi em baioneta para ouvido 250mm
- PH-58.2529 Micro bisturi reto para ouvido 250mm
- PH-58.2530 Micro espátula ponta reta 1,5mm 250mm
- PH-58.2531 Micro espátula reta, ponta curva para cima 1,5mm, 250mm comprimento
- PH-25.2015 Cabo de bisturi 25,0cm

PH-58.2501	Cureta de aspiração com fio redondo e corte ø interior 5mm com ponta em ângulo 45° 250mm	
PH-58.2502	Cureta de aspiração com fio redondo e corte cego ø interior 7mm com ponta em ângulo 45° 250mm	
PH-58.2503	Cureta em forma de colher, redonda semi angulada ø 2mm 250mm	
PH-58.2504	Cureta com fio redondo e corte, ponta em ângulo de 90° 250mm ø Externo 7,0mm, Interno 6,0mm.	
PH-58.2505	Cureta com fio redondo e corte, ponta em ângulo de 45° 250mm ø externo 7,0mm, Interno 6,0mm.	
PH-58.2506	Cureta com fio redondo e corte, ponta em ângulo de 90° 250mm ø externo 5,0mm, Interno 4,0mm.	
PH-58.2507	Cureta com fio redondo e corte, ponta em ângulo de 45° 250mm ø externo 5,0mm, Interno 4,0mm.	
PH-58.2508	Cureta com fio redondo e corte, ponta em ângulo de 90° 250mm ø externo 4,0mm, Interno 3,0mm.	
PH-58.2509	Cureta com fio redondo e corte na face interna, ponta em ângulo de 45° 250mm ø externo 4,0mm, Interno 3,0mm.	

- PH-58.2510** Cureta com fio redondo e corte, ponta com ângulo de 90°  
250mm ø externo 3mm, Interno 2,5mm
- PH-58.2511** Cureta com fio redondo e corte na face interna, ponta com ângulo de 45°  
250mm ø externo 3mm, Interno 2,5mm
- PH-58.2512** Cureta 250mm ponta 90° com fio redondo sem corte  
ø externo 3,0mm interno 2,5mm
- PH-58.2513** Cureta 250mm ponta 45° com fio redondo sem corte  
ø externo 3mm, interno 2,5mm
- PH-58.2514** Cureta de aspiração com fio redondo sem corte, ponta com ângulo de 45°  
250mm ø externo 7mm
- PH-58.2515** Cureta de aspiração 250mm ponta 45° com fio redondo sem corte  
ø externo 5,0mm
- PH-58.2516** Cureta de aspiração 250mm ponta 45° com fio redondo sem corte  
ø externo 3mm

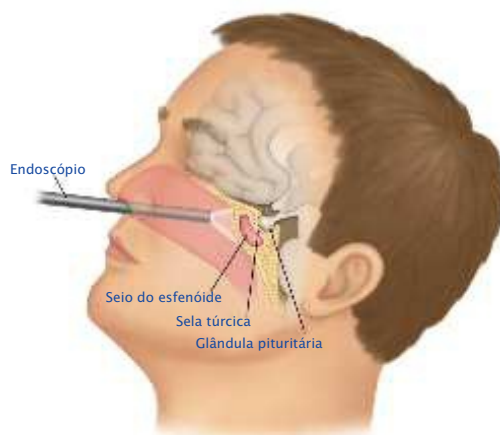

230mm



**PH-21.2933** Dissector espátula redonda, afiado ponta  
angulada 45° ø 3mm cabo recartilhado



**PH-21.2934** Dissector espátula ligeiramente curvo, afiado  
de 3mm, cabo recartilhado



**PH-21.2935** Dissector espátula ligeiramente angulado inverso  
afiado de 15°, tamanho 3mm, cabo recartilhado

190mm



**PH-21.2936** Dissector, aspirador modelo FREER, com sonda  
de dilatação

190mm



**PH-21.2937** Cureta de antro oval reta, longitudinal pequena



**PH-21.2938** Cureta de antro oval angulada, longitudinal pequena



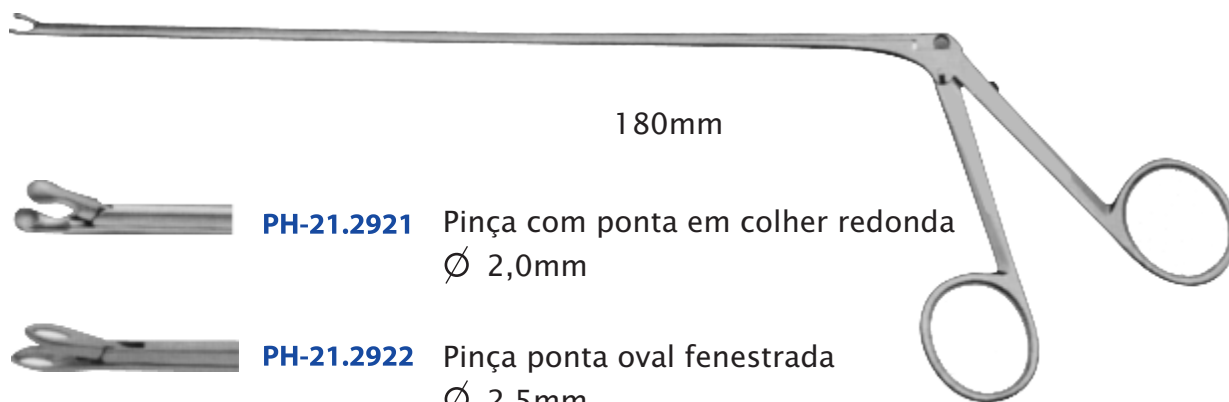

180mm



**PH-21.2921**

Pinça com ponta em colher redonda  
Ø 2,0mm



**PH-21.2922**

Pinça ponta oval fenestrada  
Ø 2,5mm

### Micro-tesoura para acesso, corte duramater e procedimentos intradural

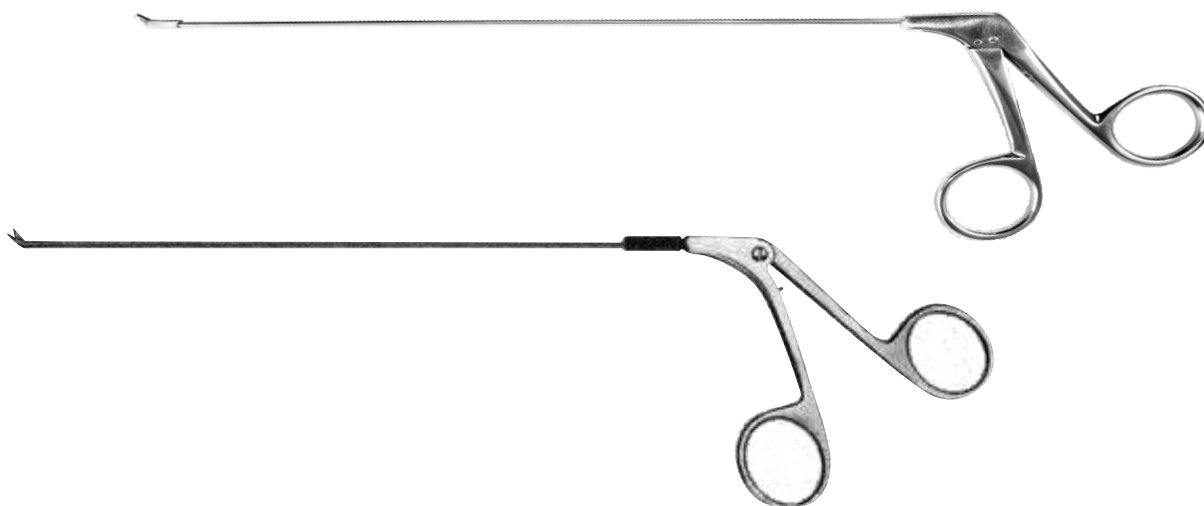

Micro-tesoura ponta reta  
180mm

**PH-21.2923**

Micro-tesoura ponta curva  
180mm

**PH-21.2925**



reta  
PH-21.2927



angulada  
PH-21.2928



Takahashi  
120mm



PH-21.2929

Tesoura nasal reta  
130mm

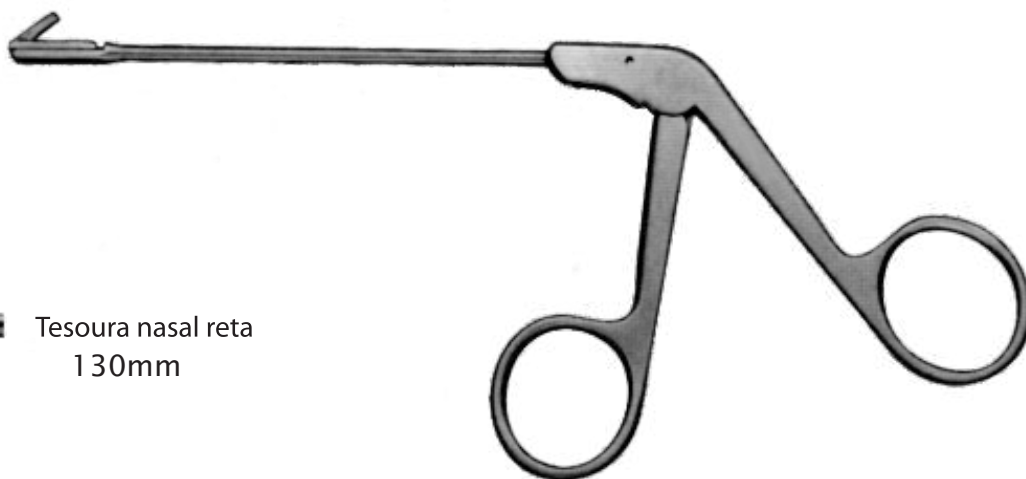

PH-21.2930

Pinça nasal afiada de corte seccional para corte liso sem danificar o tecido. Tipo Extra-suave, 45°, 130mm curva para cima tamanho 1,8 mm x 3mm



PH-21.2931

Pinça nasal afiada de corte seccional para corte liso sem danificar o tecido. Tipo Extra-suave, reta 130mm tamanho 1,8mm x 3mm



Weil-Blakesley  
120mm



**PH-21.2940** Pinça pequena reta com ponta oval fenestrada



**PH-21.2941** Pinça pequena 45° com ponta oval fenestrada



**PH-21.2942** Pinça pequena 90° com ponta oval fenestrada

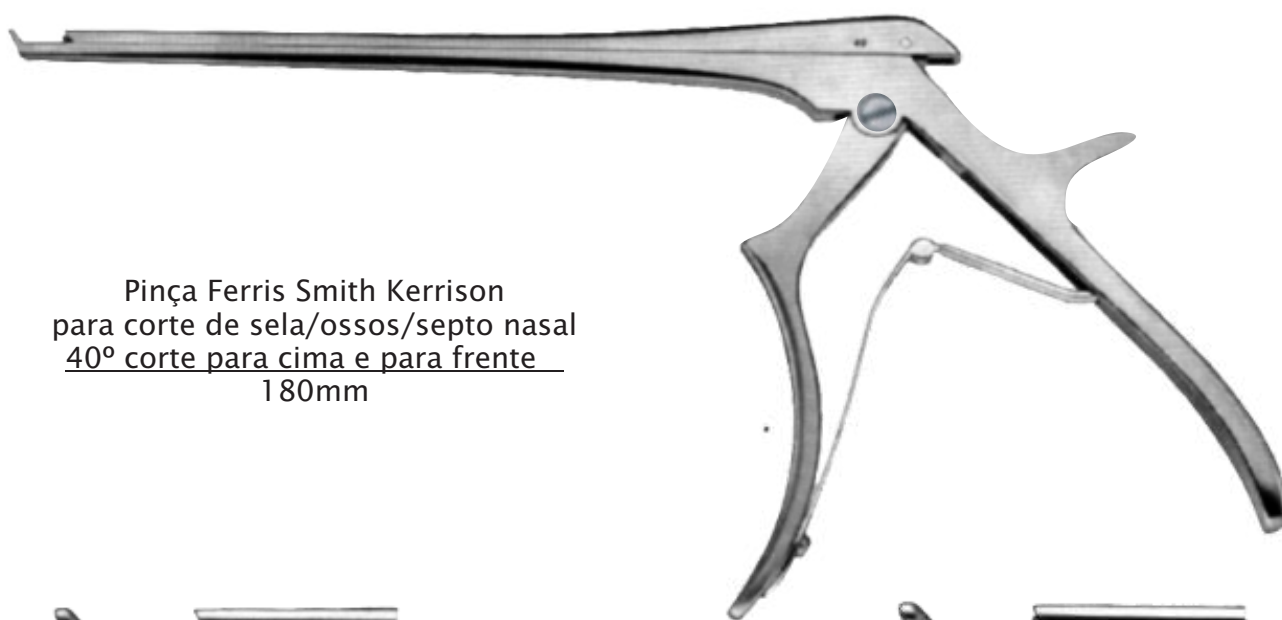

Pinça Ferris Smith Kerrison  
para corte de sela/ossos/septo nasal  
40° corte para cima e para frente  
180mm



**PH-46.1812** 2mm



**PH-46.1813** 3mm



Pinça para punção com corte circular  
para esfenóide, etmóide e atresia coanal  
180mm

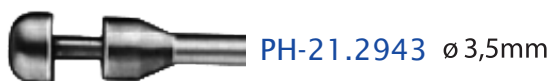

PH-21.2943 ø 3,5mm



PH-21.2944 ø 4,5mm



Pinça Goiva para  
corte de sela / septo nasal  
Middleton-Jansen

250mm  
**PH-37.3816**



Pinça Goiva para  
corte de sela / septo nasal  
Middleton-Jansen

250mm  
**PH-37.3817**

## Microtesouras e Facas para Dissecção de Aderências e Cicatrizes



Micro Tesoura  
180mm  
**PH-17.2231**



Faca Caspar ponta cega/romba  
200mm

reta  
**PH-17.2232**

angulada  
**PH-17.2233**

## Micro Dissectores Cirurgia Base Cranial Fujita



185mm  
**PH-29.1851**

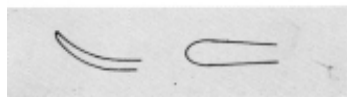

185mm  
**PH-29.1852**



185mm  
**PH-29.1853**

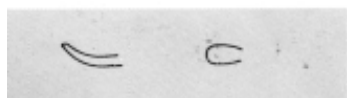

210mm  
**PH-29.2104**

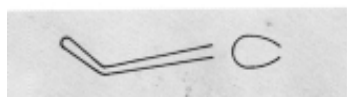

195mm  
**PH-29.1951**

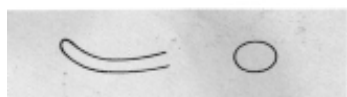

195mm  
**PH-29.1952**

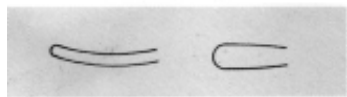

195mm  
**PH-29.1953**



195mm  
**PH-29.1954**



195mm  
**PH-29.1955**

## Ponta para Aspiração / Tubo de Sucção c/ Pressão Regulável e Intercambiável para Microcirurgia e Cirurgia Endoscópica



Ponta de aspirador fixo  
PH-18.2270

Controle de regulagem deslizante manual

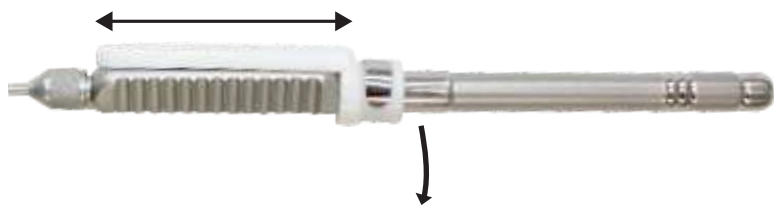

Ponta de aspirador intercambiável  
(base para encaixe) 260mm  
PH-18.2268

Entrada de ar para sucção

### **Especificações Técnicas:**

- \*Regulagem deslizante e Precisa
- \*Design Anatômico
- \*Delicado e Leve

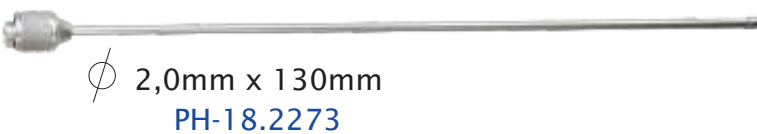

Ponteira com cureta em anel cortante  
ou cega para cirurgia endoscópica

$\phi$  2,50mm x 165mm  
PH-18.2275



Conjunto completo  
com 5 ponteiros  
PH-18.2269



Ponta de aspiração Ferguson  
angulada  $\varnothing$  3,5  
150mm  
PH-18.2276

Ponta de aspiração Ferguson  
angulada  $\varnothing$  4,0  
150mm  
PH-18.2277



Ponta de aspiração  
curvada para cima  
extremidade atrumática  
 $\varnothing$  2,5x130mm

PH-18.2278



## Suporte de Cabeça Neurocirúrgico



Conjunto completo do suporte de cabeça neurocirúrgico Mayfield:

- 01 Braço de Leyla
- 01 Adaptador para afastador autostático Leyla
- 01 Suporte apoio de cabeça
- 01 Suporte para operar sentado
- 03 Pinos Infantil
- 03 Pinos Adulto

PH-10.1775





Pinos (Infantil)  
PH-10.1769



Pinos (Adulto)  
PH-10.1768

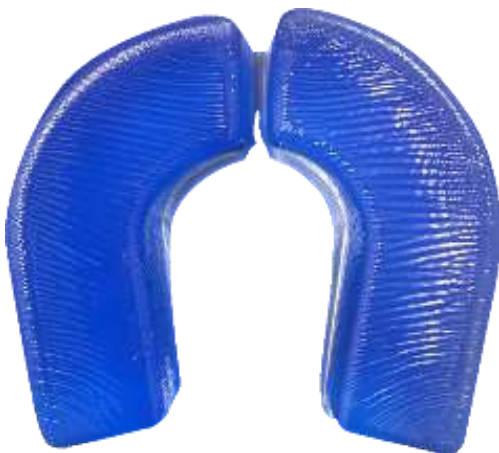

Suporte apoio de cabeça  
(tipo ferradura regulável)  
PH-10.1770



Suporte para  
operar sentado  
PH-10.1771

## Pinça de Coagulação Bipolar

Scoville-Greenwood  
PH-36.1-101-403



Cushing  
PH-36.1-102-404



Gerald  
PH-36.1-111-403



Gerald Irrigação  
PH-36.1-110-320



Hardy  
PH-36.1-121-436



Yasargil  
fabricação sob encomenda



Referência	Descrição	Ponta Ouro (mm)	Comprimento
PH-36.1-101-403	Scoville-Greenwood	1.5	19.7cm
PH-36.1-102-404	Cushing	2.0	19.0cm
PH-36.1-111-403	Gerald	1.0	19.0cm
PH-36.1-110-320	Gerald Irrigação	1.0/1.8/4cm	
PH-36.1-121-436	Hardy	0.5	24.1cm
PH-36.1-159-405	Yasargil	0.5	15.9cm
PH-36.1-159-407	Yasargil	0.7	15.9cm
PH-36.1-159-410	Yasargil	1.0	15.9cm
PH-36.1-159-413	Yasargil	1.3	15.9cm

\*Imagens meramente ilustrativas. Consulte disponibilidade de cores

## Pinça de Coagulação Bipolar

Minimally 21.6cm  
(escolher ponta)



Minimally 24.1cm  
(escolher ponta)



Minimally 27.0cm  
(ponta 0.7)



Gerald Bayonet  
Irrigação  
PH-36.1-320-10IR



Referência	Descrição	Ponta Ouro (mm)	Comprimento
PH-36.1-216-407	Minimally	0.7	21.6cm
PH-36.1-216-412	Minimally	1.2	21.6cm
PH-36.1-216-411	Minimally Ângulo 45°	0.7	21.6cm
PH-36.1-241-407	Minimally	0.7	24.1cm
PH-36.1-241-412	Minimally	1.2	24.1cm
PH-36.1-241-415	Minimally Ângulo 45°	0.7	24.1cm
PH-36.1-270-407	Minimally	0.7	27.0cm
PH-36.1-320-10 IR	Gerald Bayonet	1.0 8.4cm	

\*Imagens meramente ilustrativas. Consulte disponibilidade de cores

## Pinça de Coagulação Bipolar



**Yasargil**  
Fabricação sob encomenda

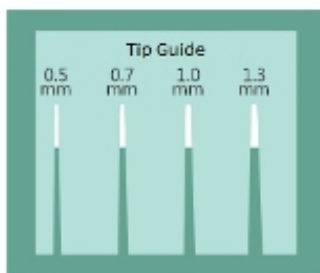

Referência	Descrição	Ponta Ouro (mm)	Comprimento
PH-36.1-181-405	Yasargil	0.5	18.1 cm
PH-36.1-181-407	Yasargil	0.7	18.1 cm
PH-36.1-181-410	Yasargil	1.0	18.1 cm
PH-36.1-181-413	Yasargil	1.3	18.1 cm

Referência	Descrição	Ponta Ouro (mm)	Comprimento
PH-36.1-200-405	Yasargil	0.5	20.0cm
PH-36.1-200-407	Yasargil	0.7	20.0cm
PH-36.1-200-410	Yasargil	1.0	20.0cm
PH-36.1-200-413	Yasargil	1.3	20.0cm

\*Imagens meramente ilustrativas. Consulte disponibilidade de cores

## Pinça de Coagulação Bipolar

Gerald 18.4cm  
(escolher ponta)  
PH-36.3-110-320



Jansen 15.2cm  
(escolher ponta)



Jansen 17.8cm  
(escolher ponta)



Jansen 20.4cm  
(escolher ponta)



Malis 17.8cm  
(escolher ponta)



Scoville Greenwood  
(escolher ponta)  
PH-36.1-110-430



\*Imagens meramente ilustrativas. Consulte disponibilidade de cores

## Pinça de Coagulação Bipolar

Yasargil

(escolher ponta)

PH-36.1-110-440



Hardy

(escolher ponta)

PH-36.1-110-460



Hardy angulada

PH-36.1-110.470

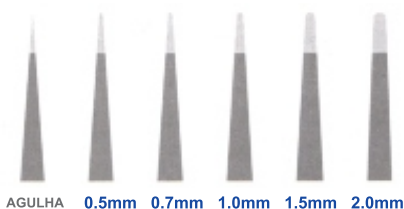

Referência	Descrição	Ponta (mm)	Comprimento
PH-36.3-110-320	Gerald	1.0-1.5-2.0	18.4cm
PH-36.3-152-005	Jansen	05	15.2cm
PH-36.3-152-010	Jansen	1.0	15.2cm
PH-36.3-152-015	Jansen	1.5	15.2cm
PH-36.3-178-005	Jansen	05	17.8cm
PH-36.1-110-360	Jansen	0.5-1.0-1.5	17.8cm
PH-36.3-178-015	Jansen	1.5	17.8cm
PH-36.3-204-005	Jansen	0.5	20.4cm
PH-36.3-204-010	Jansen	1.0	20.4cm
PH-36.3-204-015	Jansen	1.5	20.4cm
PH-36.3-178-010	Malis	1.0	17.8cm
PH-36.1-110-400	Malis	0.5-1.0-1.5-2.0	17.8cm
PH-36.3-178-020	Malis	2.0	17.8cm
PH-36.1-110-430	Scoville Greenwood	05-1.0-2.0	19.1cm
PH-36.1-110-440	Yasargil	1.0-1.5	19.7cm
PH-36.1-110-460	Hardy	1.0	21.6cm
PH-36.1-110.470	Hardy Ang.	1.0	21.6cm

\*Imagens meramente ilustrativas. Consulte disponibilidade de cores

## Pinça de Coagulação Bipolar com Irrigação

Hardy Bayonet  
(escolher ponta)  
PH-36.3-110-460 IR



Jansen Bayonet  
(escolher ponta)  
PH-36.3-110-370 IR



Scoville Greenwood  
(escolher ponta)  
PH-36.3-110-430 IR



Gerald Bayonet  
(escolher ponta)  
PH-36.3-110-320 IR

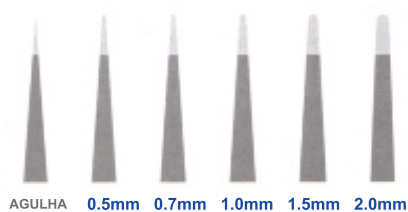

Referência	Descrição	Ponta (mm)	Comprimento
PH-36.3-110.460IR	Hardy	1.0-1.5	21.6cm
PH-36.3-110.470IR	Hardy	1.0	21.6cm
PH-36.3-110.370IR	Jansen	1.0-1.5	19.1cm
PH-36.3-110.430IR	Scoville Greenwood	1.0-1.5	19.7cm
PH-36.3-110.320IR	Gerald	1.0-1.5-2.0	18.4cm

\*Imagens meramente ilustrativas. Consulte disponibilidade de cores



Gerald Bayonet  
(escolher ponta)  
PH-36.2-110.320 NS



Jansen Bayonet  
(escolher ponta)  
PH-36.2-110.360 NS



Scoville-Greenwood  
(escolher ponta)  
PH-36.2-110.430 NS



Yasargil  
(escolher ponta)  
PH-36.1-121-440 NS



Hardy Bayonet  
(escolher ponta)  
PH-36.1-201-460 NS



Referência	Descrição	Ponta (mm)	Comprimento
PH-36.2-110.320NS	Gerald	0.5-0.7-1.0-1.5-2.0	17.8cm
PH-36.2-110.360NS	Jansen	0.5-0.7-1.0-1.5-2.0	17.8cm
PH-36.2-110.430NS	Scoville-Greenwood	0.5-0.7-1.0-1.5-2.0	19.1cm
PH-36.2-110.440NS	Yasargil	0.5-0.7-1.0-1.5-2.0	19.7cm
PH-36.2-110.460NS	Hardy	0.5-0.7-1.0-1.5-2.0	19.7cm

\*Imagens meramente ilustrativas. Consulte disponibilidade de cores

## Pinça de Coagulação Bipolar

Bayoneta



Bayoneta



Bayoneta Angulada

(ANG. P/ CIMA)  
(ANGLED UP)  
(ANG. ARRIBA)



Bayoneta Angulada

(ANG. P/ BAIXO)  
(ANGLED DOWN)  
(ANG. BAJA)



Referência	Descrição	Ponta (mm)	Comprimento
PH-36.4-140.005	Bayoneta	0.5	14.0cm
PH-36.4-140.010	Bayoneta	1.0	14.0cm
PH-36.4-140.020	Bayoneta	2.0	14.0cm
PH-36.4-610.170	Bayoneta	0.5-0.7-1-0-2.0	18.0cm
PH-36.4-610.180	Bayoneta	0.5-1-0-2.0	20.0cm
PH-36.4-610.190	Bayoneta	0.5-0.7-1-0-2.0	22.0cm
PH-36.4-200.005	Bayoneta p/ cima	0.5	20.0cm
PH-36.4-200.010	Bayoneta p/ cima	1.0	20.0cm
PH-36.4-200.020	Bayoneta p/ cima	2.0	20.0cm
PH-36.4-610.192	Bayoneta p/ cima	0.5-1-0-2.0	22.0cm
PH-36.4-610.185	Bayoneta p/ baixo	0.5-1-0-2.0	20.0cm
PH-36.4-610.195	Bayoneta p/ baixo	0.5-1-0-2.0	22.0cm

\*Imagens meramente ilustrativas. Consulte disponibilidade de cores

## Cabo para Pinça Bipolar Siliconizado

---



Cabo de silicone bipolar modelo americano redondo 3,0m  
[PH-36.5-190-100](#)

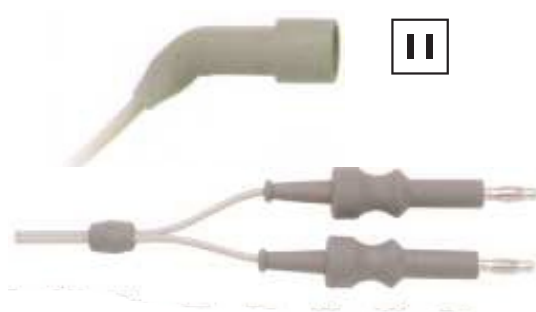

Cabo de silicone bipolar modelo europeu 3,0m  
[PH-36.5-190-170](#)

## A

ACRA-CUT Broca	57
ADSON Afastador	13
ADSON BABY Afastador	14
ADSON Descoladores/Elevadores Periósteo	87
ADSON Gancho	98
ADSON Pinça Protetora de Duramater	06
ADSON Pinça para Tumor	131
ADSON Pinça Micro-Cirúrgica	129
ADSON BROWN Pinça Micro-Cirúrgica	129
ADSON Pinça Goiva	101,109
ADSON Ponta de Aspirador/Cânula	62
AFASTADOR/DESCOLADOR	60
AFASTADOR Coluna Lombar	36
ALICATE / CORTADOR C/ WÍDIA	08,09,10
ALM Afastador	19
ANDERSON ADSON Afastador	14
ARMY NAVES/CLOWARD Afastador	26
ASPIRADOR /AFASTADOR	59,60,61,62
ASPIRADOR Ponta Fixa Regulável	166
ASPIRADOR Ponta Regulável e Intercambiável	166

## B

BACON Pinça Goiva	101
BALLENGER Faca Giratória	97
BALLENGER Cinzel	68
BECKMANN Afastador	11,12
BECKMANN ADSON Afastador	11,33
BECKMANN EATON Afastador	11
BERNARDÃO Alicate	08
BERGMANN Martelo	110
BEYER Pinça Goiva	107
BIPOLAR Pinça De Coagulação	171,172,173,174,175,176,177,178
BIPOLAR Pinça De Coagulação Intercambiável	179,180
BIPOLAR Cabo	181
BIPOLAR Pinça Descartável	170
BOHLER Pinça Goiva	104
BROCA Rocha Regulável	57
BUSHE Cureta	71

## C

CABO P/ BISTURI N° 3	63
CABO P/ BISTURI N° 4	63
CABO P/ BISTURI N° 7	64
Cadeira para Neurocirurgia	149
CASPAR Afastador/Retrator	16,37,46,47
CASPAR COUNTER Afastador/Retrator	38
CASPAR Chassi Distrator Vertebral Esquerdo/Direito (Afastador)	49,50
CASPAR Chassi Distrator c/ Guia De Broca	50
CASPAR Colocador de Enxerto	52
CASPAR Cureta	69,78
CASPAR Dissector/Impulsor/Micro Dissector	153
CASPAR Dissector Corpo Vertebral	52
CASPAR Espéculo	53,54

# Índice



**Pró-Hospitalar**  
Equipamentos Médicos Ltda

CASPAR Guia de Parafuso	49,50
CASPAR Guia de Broca Esquerdo/Direto	49,50
CASPAR Impactador de Enxerto Kit	52
CASPAR Parafuso Fixador	49,50
CASPAR Distrator Cervical Kit	51
CLOWARD Afastador	26,47,48
CLOWARD Cinzel/Osteótomo	67
CLOWARD Pinça p/ hernia de disco	134,135,136,137,138,139
COTTLE Cinzel/Descolador/Elevador Septo	68,91
COTTLE Espéculo	95
COLÔNIA Clips Metálico	06
COBB Descolador/Elevador/Osteótomo	80,81
CONE Afastador	11
COHEN Descolador/Elevador	147
COLLIN Martelo	111
COXIM p/ cirurgia de coluna	150
CRILE Gancho p/ nervos	99
CRUTCHFIELD Trator/Pontas	109
CUSHING Afastador	26
CUSHING Broca	57
CUSHING Descolador/Elevador/Rugina	87,88
CUSHING Espéculo	96
CUSHING Gancho p/ nervos	98,99
CUSHING Pinça Micro-Cirúrgica	130
CUSHING Pinça p/ hernia de disco	134,135,136,137,138,139
CUSHING Rugina	147
CURETAS ESPECIAIS Conha via lateral	74,76,77
CURETAS ESPECIAIS Tóraco/Lombar	152,153

## D

DALE Pinça Goiva	106
DANDY Pinça p/ couro cabeludo	06
DANDY Ganchos p/ nervos	98
DAVIS Afastador	26
DAVIS Descolador/Dissectores	89
D'ERRICO Trefina	58
DEGREE Micro Tesoura Vasculare	124
DESCOLADOR Afastador p/ Duramater Coluna	90
DOWNING Afastador	133

## E

ECLHIN Pinça Goiva	102
EJETOR Lâminas	22,33,55
ELEVADOR Periosteal	85,92
EPSTEIN Cureta	73
ESPÁTULAS Maleavéis	97
ESPÉCULO Afastador/Retrator	39
ESPÉCULO Mathieu Trivalve	94
ESPÉCULO Nasal Delicado Acesso Endoscópico	96
ESPÉCULO Nasal Delicado	95
ESTOJO p/ Instrumentos cirúrgicos Rothon/Hipófise	113
ESTOJO Avulso	114

# Índice



**Pró-Hospitalar**  
Equipamentos Médicos Ltda

## F

FARABEUF Afastador	29
FERRIS SMITH Pinça Kerrison p/ Hipófise	143
FERRIS SMITH Pinça Love	132
FERGUSON Pontas de Aspiração p/ Hipófise	167
FRAIZER Descolador/Dissectores/Elevadores	91
FRAIZER Cânula Ventricular/Graduada	62
FRAIZER Ponta de Aspirador/Tubo de Sucção	59,60,61
FRAIZER Ganchos p/ nervos	99
FRAZIER Tesoura Neuro Cirúrgica	146
FRANÇOIS Descolador	92
FREER Cinzel/Descolador/Elevador Septo	68,89
FRYKHOLM Pinça Goiva	106
FUJITA Descolador/Elevador	146
FUJITA Micro Dissectores Cirurgia Base Cranial	165
FULTON Pinça Goiva	107

## G

GANCHOS Sonda	99
GANCHOS c/ Mola	07
GARDNER-WELLS Trator	109
GELPI Afastador	17,20,21,22
GELPI-SEILETZ Afastador	17
GERALD Pinça Micro-Cirúrgica	130
GIGLI Cabo/Condutor/Guia	79
GIGLI Serra em aço inox	79
GIL-VERNET Afastador	27
GILLIES Ganchos p/ nervos	99
GLASER Afastador Fixo/Articulado	24
GRAHAM Ganchos p/ nervos	98

## H

HAJEK Martelo	111
HALLE Cureta	71
HALLO VEST p/ Imobilização Cervical	151
Hardy Pinça Bipolar	175
HIBBS Afastador	29
HIBBIS Cinzel Goivas	66
HIPÓFISE Ponta de Aspiração	167
HIPÓFISE Curetas	157,158,159
HIPÓFISE Aspirador/Dissector/Espátula/Microdissector	156,159
HIPÓFISE Pinças	160,161,162,163
HIPÓFISE Microtesoura/Tesoura	160,161,164
HIPÓFISE Faca p/ Dissecção	164
HOEN Descolador/Dissector/Elevador	91
HOEN Ganchos p/ nervos	98
HOEN Pinça p/ hernia de disco	133
HOHMANN Afastador/Retrator	30
HOKE Cinzel/Osteótomos	67
HOLSCHER Afastador	26
HORSLEY Descolador/Dissector/Elevador	93
HUDSON Broca	57
HUDSON Trépano Manual	58
HUDSON Extensão Cerebelar	57
HUNT YASARGIL Pinça p/ tumor	126

# Índice



**Pró-Hospitalar**  
Equipamentos Médicos Ltda

## I

INDIAN Pinça Goiva	105
INGE Afastador/Retrator	48

## J

JACOBSON Micro Porta Agulha	115
JACOBSON Micro Tesoura	121
JANETTA Afastador/Retrator	40
JANSEN MASTOIDE Afastador/Retrator	19
JANSEN SCALP Afastador/Retrator	19
JANSEN Pinça Baioneta para tumor	131
JANSEN Pinça Goiva	103
JANSEN GRUENWALD Pinça Micro-Cirúrgica	130

## K

KARLIN Descolador/Elevadores	86
KERRISON Pinça p/ Laminectomia	142,143,144
KERRISON BLACK Pinça p/ Laminectomia	145
KERRISON ANGULADA Pinça p/ Laminectomia	145
KILLIAN Cinzel/Osteótomo	68
KILLIAN CLAUS Cinzel/Osteótomo	67,68
KILLIAN Espéculo	95
KIT Completo Instrumentais Cirúrgicos (hipófise)	155
KIT Osteotomia Cervical / Lombar	112
KNIGHTON Afastador/Retrator	23
KLEINERT-KUTZ Pinça Goiva	108
KOROS Afastador/Retrator	38

## L

LAHEY Ganchos p/ nervos	99
LÂMINAS (Cegas, Dissectomia, Fenestrada, Laterais, Longitudinal, Magana, Medial, Scoville).	22,33,38,39,47,55
LAMBOTTE Cinzel/Osteótomo	65
LAMBOTTE Rugina	147
LANGENBECK Afastador/Retrator	31,32
LANGENBECK Descolador/Elevador/Rugina	147,27
LANGENBECK GREEN Afastador/Retrator	64
LATERAL Cabo p/ Bisturi	128
LAZAR Pinça Micro-Cirúrgicas	106
LEKSELL Pinça Goiva	91
LEMPERT Cinzel/Elevador Septo	103
LEMPERT Pinça Goiva	65
LEXER Cinzel/Osteótomo	82,83,84,85
LEXER Descolador/elevador	41,42,43,44,45
LEYLA Afastador/Retrator	100
LISTON KEY (HORSLEY) Cizalha	100
LISTON Cizalha	25,46
LOVE Afastador/Retrator	91
LOVE ADSON Descolador/Dissector/Elevador	134,135,136,137,138,139
LOVE GRUENWALD Pinça p/ hernia de disco	130
LUCAE Pinça Microcirúrgica	110
LUCAE Martelo	103
LUER Pinça Goiva	

# Índice



**Pró-Hospitalar**  
Equipamentos Médicos Ltda

## M

MAGANA Afastador/Retrator	37
MALIS Elevador	147
MALIS Ganchos p/ nervos	98
MALLIS Micro Tesoura	116
MALIS Pinça Bipolar	175
MACKENZIE Broca	57
MARKHAM MEYERDING Afastador/Retrator	17
MARQUARDT Pinça Goiva	107
MARTELO	110,111
MAYFIELD Pinça Goiva	108
MAYFIELD Pinos Adulto/Infantil	169
MAYFIELD Suporte Apoio de Cabeça	169
MAYFIELD Suporte p/ Operar Sentado	169
MAYFIELD Suporte de Cabeça Neurocirúrgico	168
MEAD Martelo	111
METZENBAUM Tesoura Neuro Cirúrgica	146
MEYERDING Afastador/Retrator	19,29
MICHAEL Agrafes	06
MIDDLETON JANSEN Pinça Goiva p/ Hipófise	163
MILLIGAN Descolador/Dissector/Elevadores	90

## O

OLDBERG Pinça p/ hernia de disco	132
OLIVERCRONA Descolador/Dissector/Elevadores	90
OLIVERCRONA Pinça Goiva	103

## P

PARTSCH Martelo	110
PASSADOR Cateter	141
PENFIELD'S Descolador/Dissectores/Elevadores	93
POPPEL GELPI Afastador/Retrator	17
PORTA AGULHA p/ Suturas Delicadas (Crânio/Cervical/Lombar)	115
POTTS-SMITH Pinça Micro-Cirúrgica	130
POTTS-SMITH Micro Tesoura	122
PROF. GUSMÃO Descolador/Dissector	91
PRESBYTERIAN Descolador/Elevador	147

## R

RAIZES NERVOSAS Afastador	25,26,27,46
RANEY Aplicador de Clip	06
RANEY Clips Descartável/Metálico	06
ROCHA Broca	57
RHOTON Micro Dissectores	113,114
ROTTGEN RUSKIN Pinça Goiva	108
RUSKIN Pinça Goiva	104
RUSKIN LISTON Pinça Goiva	106



# Índice



**Pró-Hospitalar**  
Equipamentos Médicos Ltda

## S

SACHS Descolador/Dissectores/Elevadores	92
SCHLESINGER Pinça p/ hérnia de disco	134,135,136,137,138,139
SCOVILLE HAVERFIELD Afastador/Retrator	35
SCOVILLE Afastador/Retrator	25,34
SCOVILLE Cureta Especiais	153
SCOVILLE Ganchos	35
SCOVILLE Lâminas	35
SEMB Cizalha/Pinça Goiva	100,102
SEMKEN Pinça Micro-Cirúrgica	129
SENN GREEN Afastador/Retrator	27
SENN MULLER Afastador/Retrator	27
SENN MULLER BABY Afastador/Retrator	27
SICARD Pinça Goiva	104
SIMON Cureta	70
SCHNITMAN JANSEN Afastador/Retrator	19
SMITH PETERSEN Pinça Goiva	107
SMITH PETERSEN Cinzel/Osteótomos	67
SOFIELD Afastador/Retrator	56
SPINAL Cureta	73,74,75,76,77
SPINAL Osteótomo	85
SPURLING Pinça p/ hernia de disco	134,135,136,137,138,139
STILLE Cinzel/Osteótomo	66
STILLE Pinça Goiva	102
STILLE LISTON Cizalha	100
STILLE LUER Pinça Goiva	102
STILLE RUSKIN Pinça Goiva	106
STRULLY Tesoura Neuro Cirúrgica	146
STRULLY Cabo de Serra de Gigli	79

## T

TAKAHASHI Pinça p/ Hipófise	106
TAYLOR Afastador/Retrator	28,29
TAYLOR Tesoura Neuro Cirúrgica	145
TAYLOR Pinça Micro-Cirúrgica	130
TONNIS Descolador/Dissector/Elevador	93
TREFINA de Biópsia	148
TROCATER	148
TWIST DRILL Broca Caspar	49,50
TWIST DRILL	58

## V

VALIN Afastador/Retrator	33
VANNAS Micro Tesoura	123
VASCULAR Micro Tesoura	124
VERTICAL Cabo p/ Bisturi	64
VOLKMANN Cureta	72

# Índice



**Pró-Hospitalar**  
Equipamentos Médicos Ltda

## W

WEITLANER Afastador	14,15,16
WEIL-BLAKESLEY Pinça p/ Hipófise	162
WILDE Pinça p/ Tumor	131
WILDE Pinça p/ Hérnia de Disco	133
WILLIAMS Afastador/Retrator	18
WILLIAMS Ponta de Aspirador/Retrator	62
WILLINGER Cureta	75
WOODSON Descolador/Dissectores/Elevadores	89

## Y

YASARGIL Descolador/Dissectores/Cinzel/Elevador	89
YASARGIL Micro Tesoura/Tesoura	117,118,119,120,123
YASARGIL Pinça Dissecção Micro-Cirúrgica/Tumores	125,127
YASARGIL Pinça Bipolar	175
YASARGIL SAMII Pinça Dissecção/Tumor	126

## Z

ZAUFAL JANSEN Pinça Goiva	108
---------------------------	-----

Rua Severino Lara, 09 - CEP 31610-260 - Belo Horizonte / MG / Brasil

\*55 (31) 3071-6200 / [prohospitalar@prohospitalar.com.br](mailto:prohospitalar@prohospitalar.com.br)

[sac@prohospitalar.com.br](mailto:sac@prohospitalar.com.br)

[www.prohospitalar.com.br](http://www.prohospitalar.com.br)