



Pró-Hospitalar
Equipamentos Médicos Ltda

NÚMERO NO MS 02
Conforme classes de risco

A EMPRESA 03
Conheça a Pró-Hospitalar

POLÍTICA DE QUALIDADE 04
Pilares e transparência

CATÁLOGO 05
Lista de produtos

ÍNDICE 182
Lista de referência dos produtos

Número no Ministério da Saúde

ANDADOR DE TRAÇÃO	80061790042
ANACNC	80061790036
ASPIRADORES	80061790047
COXIM	80061790032
CADEIRA DE TRAÇÃO	80061790041
HALO VEST	80061790040
MAYFIELD	80061790009
INSTRUMENTAIS COM WIDIA	80061790045
INSTRUMENTAIS COM CONEXÃO	80061790033
INSTRUMENTAIS GERAIS	80061790048
INSTRUMENTAIS DE TITÂNIO	80061790044
MARTELOS	80061790046
MARTELO POLIACETAL	80061790002
PINÇAS BIPOLARES	80061790039



Pró-Hospitalar
Equipamentos Médicos Ltda

A EMPRESA

Atuando no mercado desde 1988, a Pró-Hospitalar Equipamentos Médicos dedica-se com eficiência à industrialização e comercialização de instrumentos médicos, cirúrgicos e hospitalares. Qualidade é um compromisso real da nossa empresa.

MISSÃO

Fornecer instrumentais cirúrgicos da mais alta qualidade do Brasil.

VISÃO

Atender às necessidades de cada cliente de forma satisfatória e conquistar a liderança nacional até 2025.

VALORES

- * Qualidade em tudo que faz;
- * Pessoas comprometidas e realizadas;
- * Cliente satisfeito;
- * Gestão participativa;
- * Diversidade;
- * Relacionamentos abertos e honestos por meio da comunicação.



POLÍTICA DE QUALIDADE

Nosso sistema da qualidade está fundamentado:

- Na Satisfação de nossos clientes e parceiros;
- Na Comunidade e ambiente onde estamos inseridos;
- No Respeito ao meio ambiente e à sustentabilidade;
- Na Formação contínua de nossos colaboradores.

SUSTENTADA PELOS SEGUINTE PILARES:

- Qualidade total dos nossos produtos e serviços.
- Melhoria contínua dos processos.
- Amparo total na legislação.
- Infraestrutura adequada e humanizada.
- Treinamento e reciclagens constantes.

TRANSPARÊNCIA

A Pró-Hospitalar é líder no mercado nacional atendendo diversos hospitais, médicos, clínicas e empresas em geral. Fidelidade e comprometimento na fabricação dos produtos são atitudes que valorizamos.

A empresa investe em tecnologia e atualiza produtos e serviços para oferecer aos seus clientes a melhor solução em instrumentais cirúrgicos.





Pró-Hospitalar
Equipamentos Médicos Ltda

NOSSOS PRODUTOS

Consulte também nosso catálogo on-line
www.prohospitalar.com.br

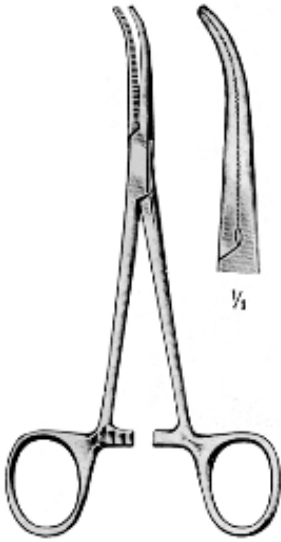

Pinça de Dandy
para couro cabeludo
14,0cm
PH-01.1802

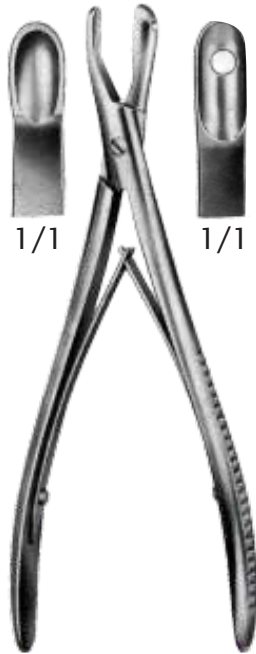

Pinça Adson
protetora de duramater
20,0cm
PH-01.1801
15,0cm
PH-23.6240

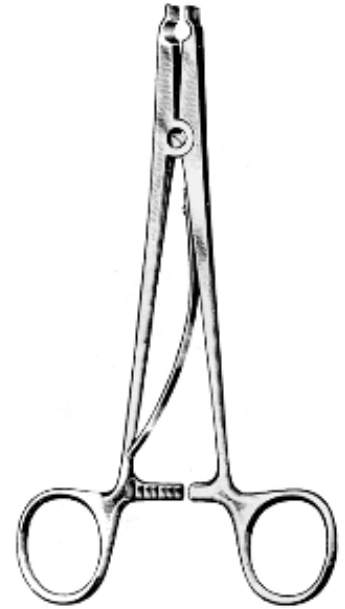

Aplicador de clip de Raney
metálico
PH-01.1790

Scalp para couro
cabeludo e Hemostasia



Agrafe de Michael
pacote com
100 unidades



Clip de Raney
metálico descartável
PH-01.1795 PH-01.1796



Clip de Colônia
metálico
PH-01.1800

Referência	Comprimento x Tamanho
PH-01.1403	 14x3mm
PH-01.1603	 16x3mm
PH-01.1803	 18x3mm
PH-01.2003	 20x3mm
PH-01.2203	 22x3mm



Gancho com mola Yasargil para fixação de galea

pequeno
PH-01.1903

grande
PH-01.1904

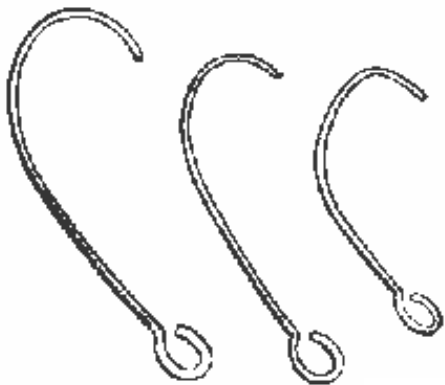

Gancho escalpo
Fukushima

pequeno
PH-01.1905

médio
PH-01.1906

grande
PH-01.1907



Gancho com mola

pequeno
PH-01.1900

médio
PH-01.1901

grande
PH-01.1902



Alicate Bernardão
para cortes de barras e fios
até \varnothing 6,0mm com Widia

PH-14.0014 30cm

PH-01.0047 47cm

PH-01.0060 60cm



Cortador de fios \varnothing 4,0/5,0/5,5/6,0mm
560mm fechado
710mm aberto

PH-01.0040



Alicate com wídia
para corte de fio de
aço 0,0 a 3,0mm

PH-01.0025



Alicate com wídia
18,0cm para corte de
fio de aço 0,0 a 2,0mm

PH-01.0026



Alicate com wídia
para corte de fio de
aço 0,0 a 2,0mm

PH-01.0027



Alicate universal com corte
22cm
PH-01.0028



Alicate de pressão
em aço inox
18cm
PH-01.0029
20cm
PH-01.0030

Afastadores / Retratores Auto-Retensão Hemilaminectomia / Laminectomia



Beckman Adson 4x4 dentes cegos
31cm

Profundidade

25x25mm

PH-01.2525

25x32mm

PH-01.2532

25x44mm

PH-01.2544



Beckman Eaton 7x7 dentes afiados
32,4cm

afiado

PH-01.1030

cego

PH-01.1031



Cone 3x4 dentes
Afiados

16,2cm

PH-01.0162

20,3cm

PH-01.0203



Adson 5x6 dentes

afiados
24cm
PH-01.2436
27cm
PH-01.2738

cegos
24cm
PH-01.2437
27cm
PH-01.2739



Adson modificado
27cm

afiado
PH-01.1048
cego
PH-01.1049



Adson curvo 3x4 dentes
27cm

afiado
PH-01.1019

cego
PH-01.1021



Adson reto 4x4 dentes

afiados
18cm
PH-01.1011
20cm
PH-01.1000

cegos
18cm
PH-01.1012
20cm
PH-01.1001

Afastadores / Retratores Auto-Estáticos / Auto-Retenção



H-01.103P



3x4 Dentes
afiado
PH-01.1035
cego



Beckman
31 cm

5x6 Dentes
afiado
PH-01.1036
cego
PH-01.1038



Beckmann 4x4 Dentes
20cm
afiado
PH-01.1044
cego
PH-01.1045



Beckmann 4x4 Dentes
30,5cm
afiado
PH-01.1040
cego
PH-01.1041

Afastadores / Retratores Auto-Estáticos / Auto-Retenção



Anderson Adson

20cm

4x4 dentes

afiado

PH-01.1020

cego

PH-01.1203

5x5 dentes

afiado

PH-01.1022

cego

PH-01.1205

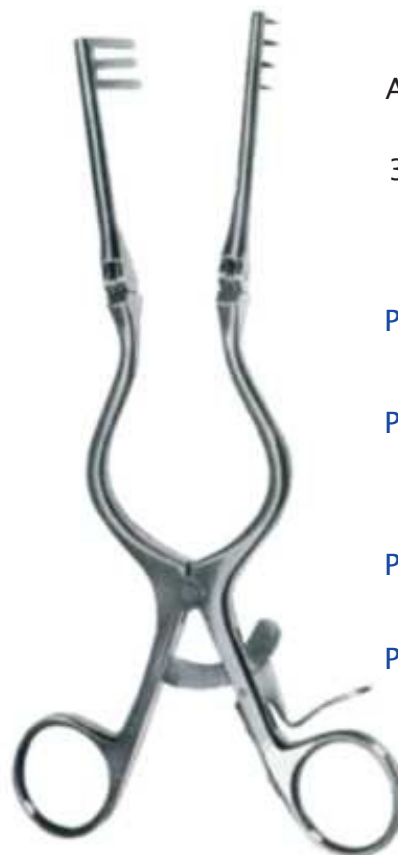

Adson Baby longo

3x4 dentes

afiado

20cm

PH-02.1020

26cm

PH-02.1026

cego

20cm

PH-02.1200

26cm

PH-02.1126



Adson

3x4 dentes curto

afiado

14cm

PH-02.1090

16cm

PH-02.1100

cego

14cm

PH-02.1091

16cm

PH-02.1101



Weitlaner

3x4 dentes reto

afiado

13cm

PH-02.1042

16,5cm

PH-02.1051

cego

13cm

PH-02.1043

16,5cm

PH-02.1052

Afastadores / Retratores Auto-Estáticos / Auto-Retenção



Weitlaner 2x3 dentes
reto

afiado

10,5cm

PH-02.1040

14cm

PH-02.1041

16,5cm

PH-02.1050

cego

10,5cm

PH-02.1045

14cm

PH-02.1046

16,5cm

PH-02.1055



Weitlaner 3x3 dentes
meio curvo

afiado

13cm

PH-02.1044

16,5cm

PH-02.1047

cego

13cm

PH-02.1048

16,5cm

PH-02.1049



3x4 dentes

afiado

20cm

PH-02.1111

25cm

PH-02.1120

cego

20cm

PH-02.1112

25cm

PH-02.1121



5x6 dentes

afiado

25cm

PH-02.1122

cego

25cm

PH-02.1123

Afastadores / Retratores Auto-estático
Auto-Retenção / Retrator de Mão



Caspar
25cm



Gelpi Loktite com anel de proteção
18cm
PH-04.1270



Gelpi Perineal
18cm
PH-04.1275



Gelpi Poppen
14cm
PH-04.1280



Gelpi-Seiletz
15cm
PH-04.1285



Direito



Esquerdo

Markham-Meyerdung abertura 95mm
17,8cm

Lâmina 25x51mm direito

PH-03.2551

Lâmina 25x51mm esquerdo

PH-03.2552

Afastadores / Retratores Auto-Retensão para Microdissectomia

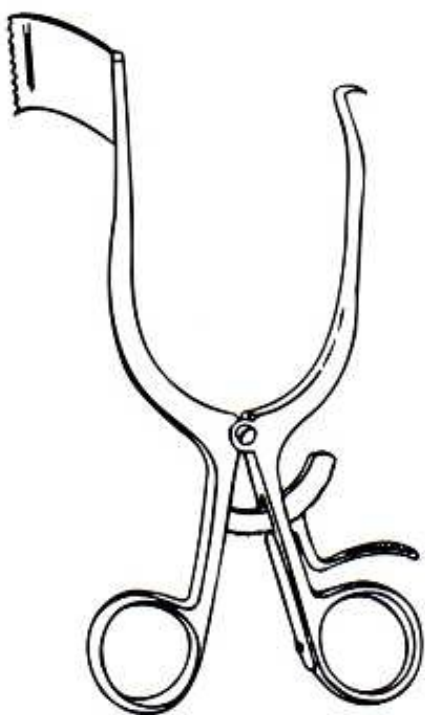

Williams
esquerdo

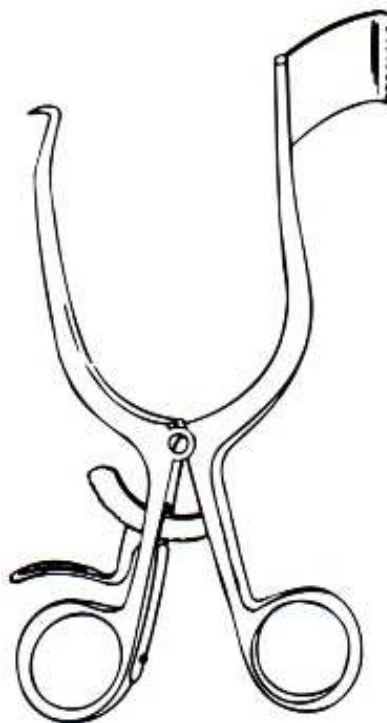

Williams
direito

Comprimento total 17cm

direito
50x10mm
PH-03.5010
60x10mm
PH-03.6010
70x10mm
PH-03.7010

esquerdo
50x10mm
PH-04.5010
60x10mm
PH-04.6010
70x10mm
PH-04.7010

direito
50x20mm
PH-03.5020
60x20mm
PH-03.6020
70x20mm
PH-03.7020

esquerdo
50x20mm
PH-04.5020
60x20mm
PH-04.6020
70x20mm
PH-04.7020

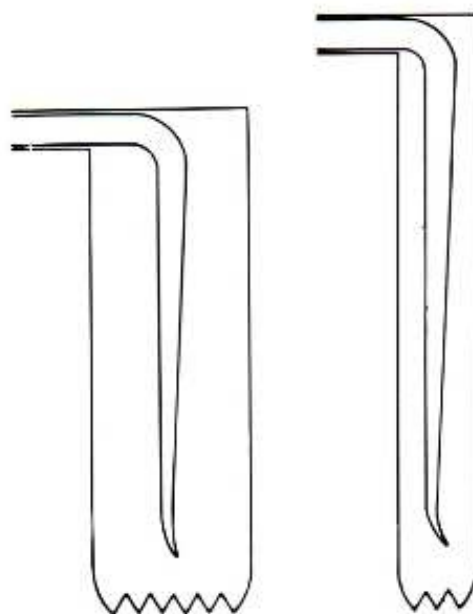

Lâmina 20mm

Lâmina 10mm



Jansen Mastoide 3x3 dentes
abertura total 44mm
10,2cm
afiado
PH-04.1240
cego
PH-04.1235



Jansen Schnitman 3x3 dentes
abertura total 51mm
10,6cm
afiado
PH-04.1239
cego
PH-04.1238



Jansen Scalp 4x4 dentes
abertura total 76mm
11,7cm
afiado
PH-04.1237
cego
PH-04.1236



Alm
afiado
70mm
PH-04.1255
100mm
PH-04.1265
cego
70mm
PH-04.1256
100mm
PH-04.1266



Meyerding
abertura 9,5cm
16,5cm
Lâmina 25x41mm
PH-04.2541
Lâmina 25x51mm
PH-04.2551
Lâmina 25x57mm
PH-04.2557

Afastadores / Retratores Auto-Estático Auto-Retenção Coluna Lombar e Torácica



Gelpi Longo com garra 4x4 dentes, Retenção
com Parafuso ou Cremalheira
240mm

Afiados			Cegos		
Código	Angulo	Medida Gancho	Código	Angulo	Medida Gancho
PH-04.1297	60°	60mm	PH-04.1298	60°	60mm
PH-04.1305	60°	70mm	PH-04.1306	60°	70mm
PH-04.1313	60°	80mm	PH-04.1314	60°	80mm
PH-04.1321	60°	90mm	PH-04.1322	60°	90mm
PH-04.1299	90°	60mm	PH-04.1300	90°	60mm
PH-04.1307	90°	70mm	PH-04.1308	90°	70mm
PH-04.1315	90°	80mm	PH-04.1316	90°	80mm
PH-04.1323	90°	90mm	PH-04.1324	90°	90mm

Gelpi Extra-Longo com garra 4x4 dentes, Retenção
com Parafuso ou Cremalheira
290mm

Afiados			Cegos		
Código	Angulo	Medida Gancho	Código	Angulo	Medida Gancho
PH-04.1317	60°	60mm	PH-04.1318	60°	60mm
PH-04.1309	60°	70mm	PH-04.1310	60°	70mm
PH-04.1301	60°	80mm	PH-04.1302	60°	80mm
PH-04.1325	60°	90mm	PH-04.1326	60°	90mm
PH-04.1319	90°	60mm	PH-04.1320	90°	60mm
PH-04.1311	90°	70mm	PH-04.1312	90°	70mm
PH-04.1303	90°	80mm	PH-04.1304	90°	80mm
PH-04.1327	90°	90mm	PH-04.1328	90°	90mm



Angulado

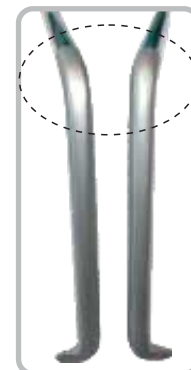

Gelpi extra-longo com gancho, retenção com parafuso ou cremalheira

24,0cm

29,0cm

Código	Angulo	Medida Gancho	Código	Angulo	Medida Gancho
PH-04.1290	60°	60mm	PH-04.1282	60°	60mm
PH-04.1274	60°	70mm	PH-04.1277	60°	70mm
PH-04.1279	60°	80mm	PH-04.1295	60°	80mm
PH-04.1284	60°	90mm	PH-04.1287	60°	90mm
PH-04.1291	90°	60mm	PH-04.1283	90°	60mm
PH-04.1276	90°	70mm	PH-04.1278	90°	70mm
PH-04.1281	90°	80mm	PH-04.1296	90°	80mm
PH-04.1286	90°	90mm	PH-04.1288	90°	90mm

Parafuso



Cremalheira



Afastadores / Retratores Auto-Estático Auto-Retenção Coluna Lombar e Torácica



Encaixe rápido



Gelpi modificado com
lâminas e gancho
20,5cm

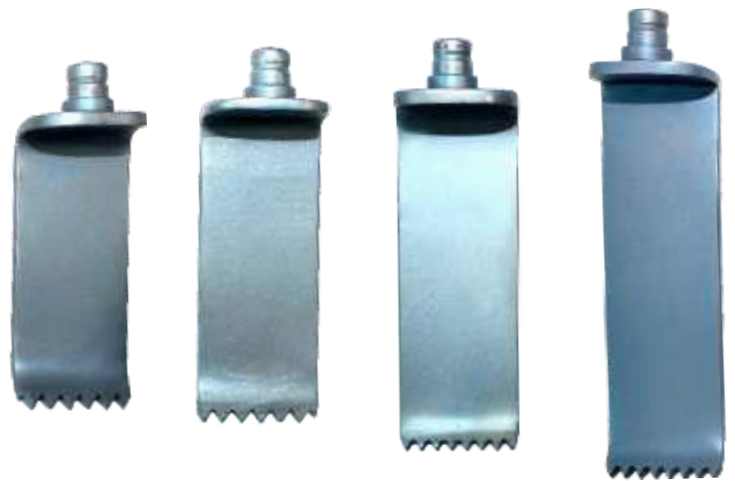

25x55mm

25x60mm

25x70mm

25x80mm

Kit afastador	Gancho	Lâmina
PH-07.1245	45mm	25x55mm
PH-07.1250	50mm	25x60mm
PH-07.1260	60mm	25x70mm
PH-07.1270	70mm	25x80mm

Cada kit corresponde a um tamanho de gancho e um tamanho de lâmina.

Venda lâminas avulsas	
PH-07.1255	25x55mm
PH-07.1247	25x60mm
PH-07.1248	25x70mm
PH-07.1280	25x80mm



Ejetor de lâminas
PH-07.1254

Ejetor de lâminas acompanha o kit

Afastadores / Retratores Auto-Estático Auto-Retensão Coluna Lombar e Torácica



Knighton modificado
com lâmina, gancho
e sistema de cremalheira
19cm



25x55mm

25x60mm

25x70mm

25x80mm

Kit afastador	Gancho	Lâmina
PH-07.1246	45mm	25x55mm
PH-07.1251	50mm	25x60mm
PH-07.1261	60mm	25x70mm
PH-07.1271	70mm	25x80mm

Cada kit corresponde a um tamanho de gancho e um tamanho de lâmina.

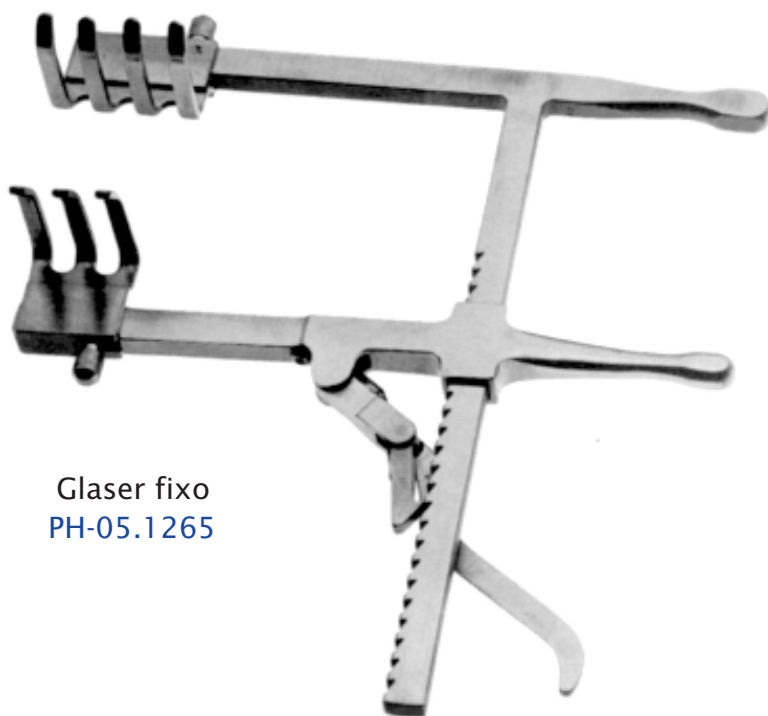

Glaser fixo
PH-05.1265



32x38mm
PH-05.3238

51x66mm
PH-05.5166

44x38mm
PH-05.4438



Glaser articulado
PH-05.1266

Kit

Abertura total (11,4cm)
03 Lâminas (01 pequena, 01 média, 01 grande)

Afastadores / Retratores de Mão de tecidos moles e raízes nervosas

Largura x Comprimento

3mmx70mm 3mmx100mm

PH-05.7003 PH-05.1003

5mmx70mm 5mmx100mm

PH-05.7005 PH-05.1005

7mmx70mm 7mmx100mm

PH-05.7007 PH-05.1007

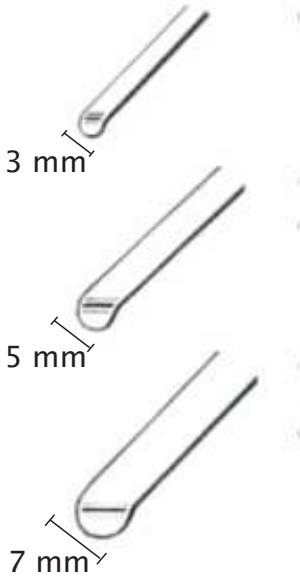

Love 210mm



Scoville reto
23cm

PH-05.2307



Scoville meio angulado
23cm

PH-05.2407



Scoville angulado
23cm

PH-05.2507

Afastadores / Retratores de Mão de tecidos moles e raízes nervosas



Army Naves
11,4cm

Lâminas
18mm
PH-05.1118
20mm
PH-05.1120
23mm
PH-05.1123



Cushing
19,7cm

Lâminas
9,5x6,4mm
PH-05.9564



Cushing
24cm

10mm
PH-24.1001
12mm
PH-24.1002
14mm
PH-24.1004
16mm
PH-24.1006

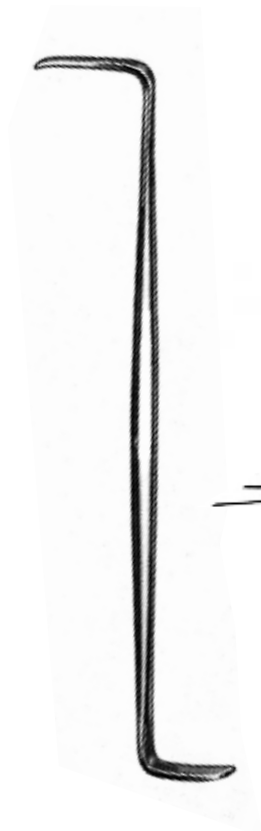

Davis
14cm

19mm
6mm
PH-06.0176
22mm
8mm
PH-06.0177

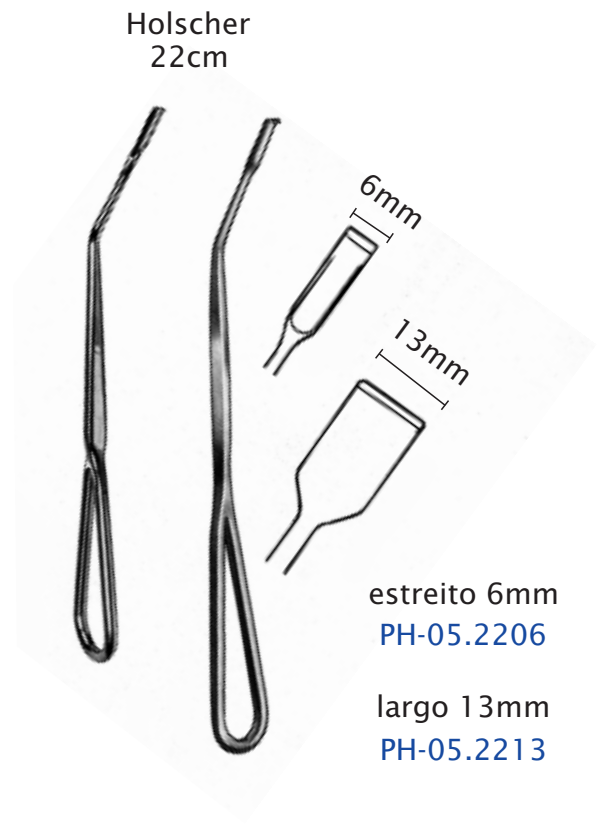

Holscher
22cm

6mm
13mm
estreito 6mm
PH-05.2206
largo 13mm
PH-05.2213

Afastadores / Retratores de Mão de tecidos moles e raízes nervosas



Langenbeck-Green
16cm



PH-06.1600



PH-06.1601



PH-06.1603



11x13mm
PH-06.1602



16x6mm
PH-06.1604



25x6mm
PH-06.1605



Senn-Muller
16cm

afiado
PH-06.1391



cego
PH-06.1392



Senn-Green
15cm



10x6mm
PH-06.1006



20x6mm
PH-06.1061



Gil-Vernet
24cm

17mm
PH-06.2417

20mm
PH-06.2420



Senn-Muller Baby
16cm



afiado
PH-06.1390



cego
PH-06.1395

Afastador Taylor com
cabo e lâmina
longitudinal

25x76mm

PH-05.2576

25x102mm

PH-05.2502

32x76mm

PH-05.3276

32x102mm

PH-05.3102

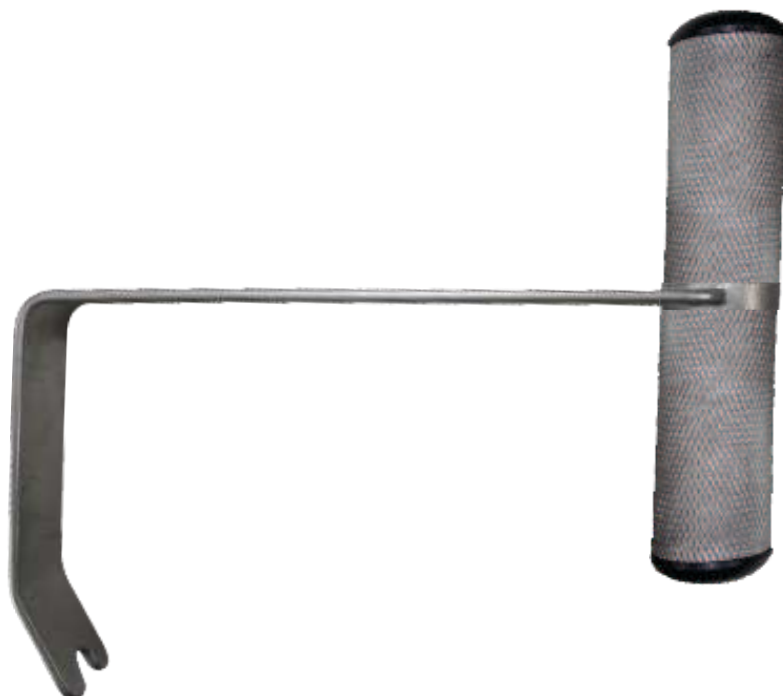

Comprimento do cabo até a curva da haste 184mm



Afastador Taylor com
cabo e lâmina medial

25x76mm

PH-06.2577

25x102mm

PH-06.2503

32x76mm

PH-06.3277

32x102mm

PH-06.3103

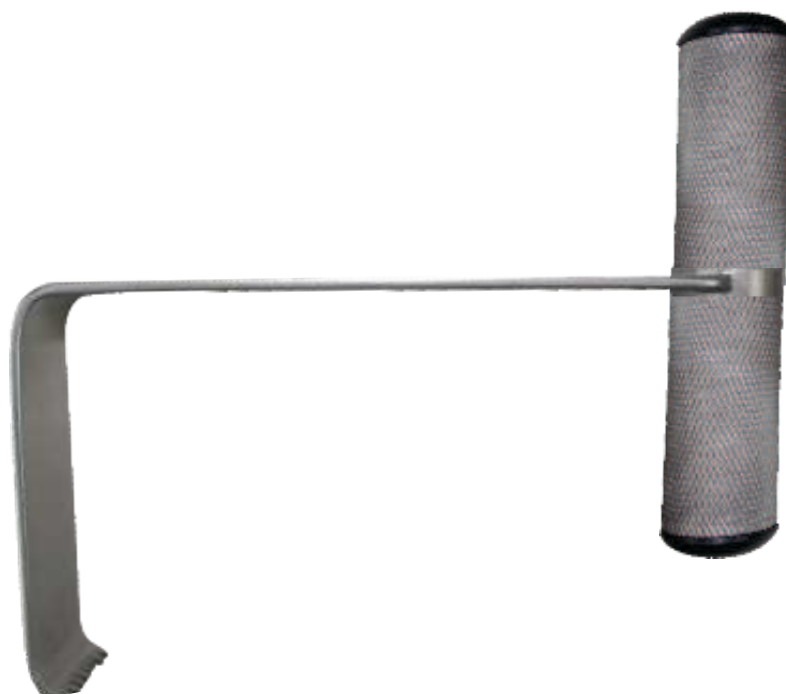

Afastadores / Retratores Espinhal Retratores de Mão



Taylor
18,4cm

15x90mm
PH-06.1590
20x90mm
PH-06.2900
25x76mm
PH-06.2576
25x102mm
PH-06.2502
30x76mm
PH-06.3076
32x76mm
PH-06.3276
32x102mm
PH-06.3202
40x76mm
PH-06.4076

40x90mm
PH-06.4090
40x102mm
PH-06.4002
40x120mm
PH-06.4020
60x76mm
PH-06.6076
60x90mm
PH-06.6090
60x102mm
PH-06.6010
60x120mm
PH-06.6020



Hibbs
22cm
25x75mm
PH-06.2575
24cm
25x80mm
PH-06.2580



Meyerding
20cm
50x16mm
PH-06.1315
220mm
75x25mm
PH-06.1320
240mm
90x50mm
PH-06.1325

Farabeuf
12cm
PH-06.1201



Farabeuf
15cm
PH-06.1501



Farabeuf
Baby
7x100mm
PH-06.1008

Infantil
10x120mm
PH-06.1009

Adulto
13x125mm
PH-06.1010

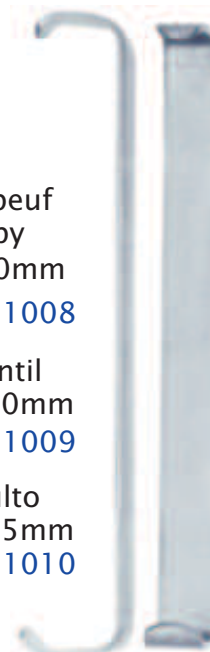

Afastador / Retrator de Mão

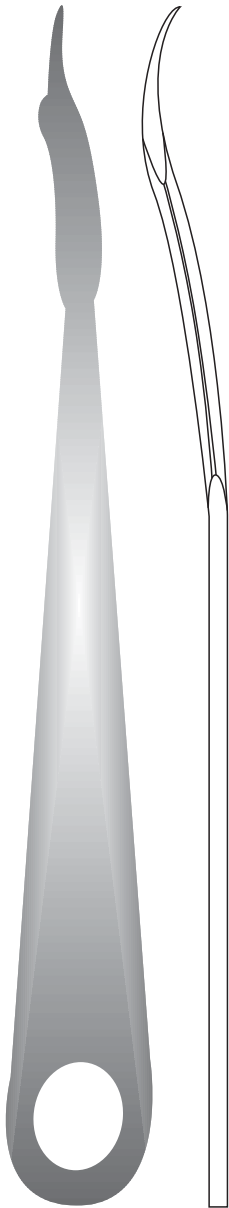

Afastador Hohmann 22cm
lâmina 8mm ponta fina

PH-06.0822

Afastador Hohmann curvo
22cm lâmina 8mm ponta fina

PH-06.0823

Afastador Hohmann meio curvo
22cm lâmina 8mm ponta fina

PH-06.0824

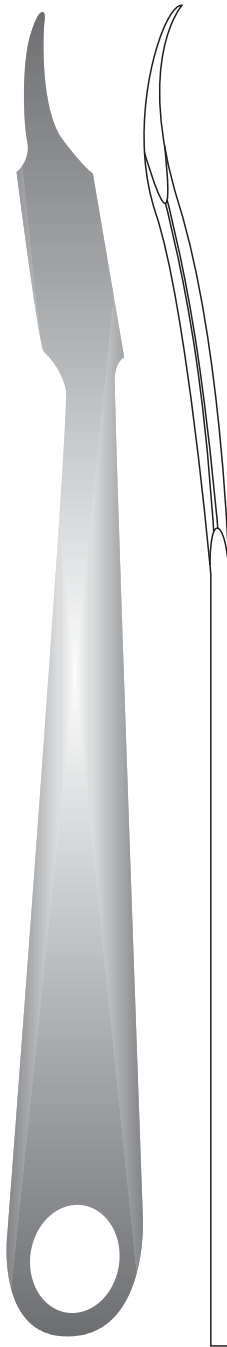

Afastador Hohmann 22cm
lâmina 18mm ponta fina

PH-06.1822

Afastador Hohmann curvo
22cm lâmina 18mm ponta fina

PH-06.1823

Afastador Hohmann meio curvo
22cm lâmina 18mm ponta fina

PH-06.1824

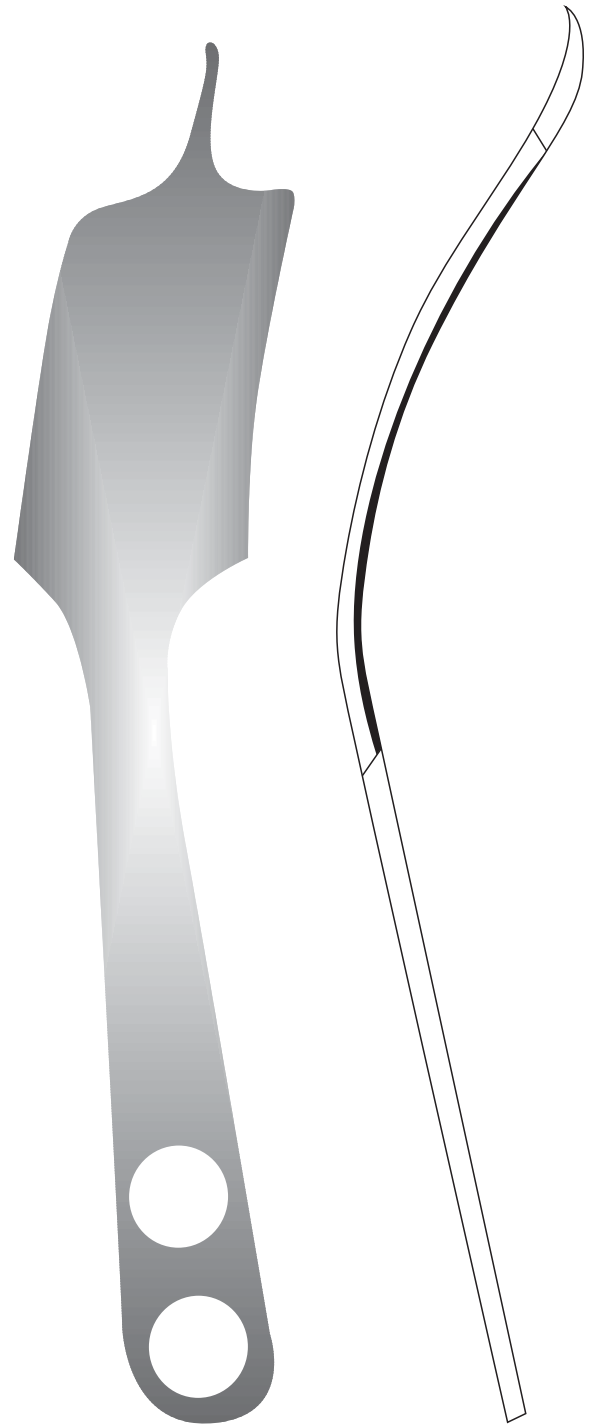

Afastador Hohmann 25cm
lâmina 43mm ponta fina

PH-06.4325

Afastador Hohmann curvo
25cm lâmina 43mm ponta fina

PH-06.4326

Afastador Hohmann meio curvo
25cm lâmina 43mm ponta fina

PH-06.4327

Afastador / Retrator de Mão



Langenbeck
25cm

Largura x Comprimento da lâmina

10x30mm PH-06.1030	15x30mm PH-06.1530	20x30mm PH-06.2030	25x30mm PH-06.2530
10x35mm PH-06.1035	15x35mm PH-06.1535	20x35mm PH-06.2035	25x35mm PH-06.2535
10x40mm PH-06.1040	15x40mm PH-06.1540	20x40mm PH-06.2040	25x40mm PH-06.2540
10x45mm PH-06.1045	15x45mm PH-06.1545	20x45mm PH-06.2045	25x45mm PH-06.2545
10x50mm PH-06.1050	15x50mm PH-06.1550	20x50mm PH-06.2050	25x50mm PH-06.2550
10x55mm PH-06.1055	15x55mm PH-06.1555	20x55mm PH-06.2055	25x55mm PH-06.2555
10x60mm PH-06.1060	15x60mm PH-06.1560	20x60mm PH-06.2060	25x60mm PH-06.2560
10x70mm PH-06.1070	15x70mm PH-06.1570	20x70mm PH-06.2070	25x70mm PH-06.2570
30x30mm PH-06.3030	35x30mm PH-06.3530	40x30mm PH-06.4030	45x30mm PH-06.4530
30x35mm PH-06.3035	35x35mm PH-06.3535	40x35mm PH-06.4035	45x35mm PH-06.4535
30x40mm PH-06.3040	35x40mm PH-06.3540	40x40mm PH-06.4040	45x40mm PH-06.4540
30x45mm PH-06.3045	35x45mm PH-06.3545	40x45mm PH-06.4045	45x45mm PH-06.4545
30x50mm PH-06.3050	35x50mm PH-06.3550	40x50mm PH-06.4050	45x50mm PH-06.4550
30x55mm PH-06.3055	35x55mm PH-06.3555	40x55mm PH-06.4055	45x55mm PH-06.4555
30x60mm PH-06.3060	35x60mm PH-06.3560	40x60mm PH-06.4060	45x60mm PH-06.4560
30x70mm PH-06.3070	35x70mm PH-06.3570	40x70mm PH-06.4070	45x70mm PH-06.4570

Afastador/Retrator para Via de Acesso Torácico Anterior

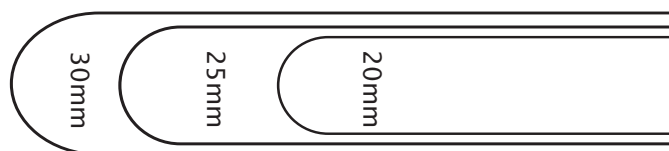
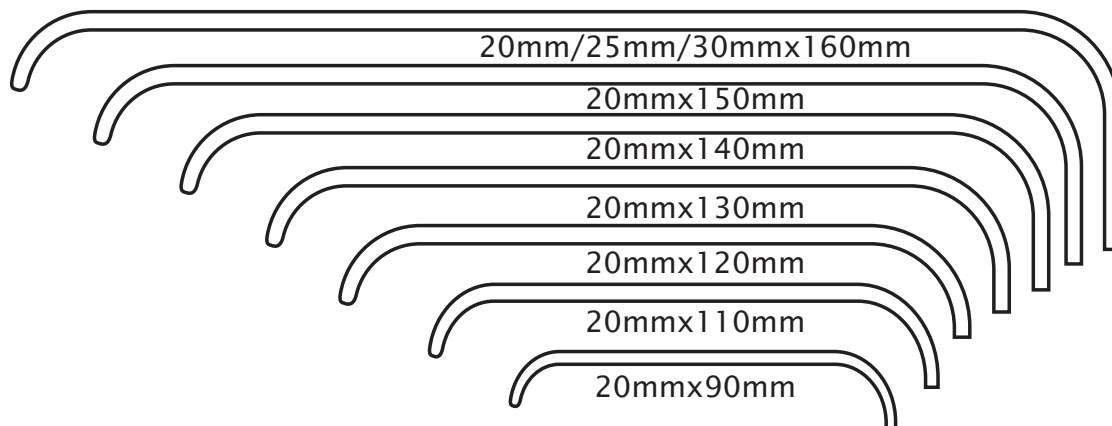

Langenbeck
25cm

estreito	médio	largo
20mmx90mm PH-06.2090	25mmx100mm PH-06.2510	30mmx100mm PH-06.3010
20mmx110mm PH-06.2011	25mmx120mm PH-06.2520	30mmx120mm PH-06.3012
20mmx130mm PH-06.2013	25mmx140mm PH-06.2514	30mmx140mm PH-06.3014
20mmx150mm PH-06.2015	25mmx160mm PH-06.2516	30mmx160mm PH-06.3016



Afastadores / Retratores Auto-Retenção / Hemilaminectomia



Afastador
downing com cremalheira
incluindo 03 ganchos e 03 lâminas
PH-07.2000



Ganchos
38mm
PH-07.0138
51mm
PH-07.0651
76mm
PH-07.0751



Lâminas
51x38mm
PH-07.5138
64x51mm
PH-07.6451
76x51mm
PH-07.7651

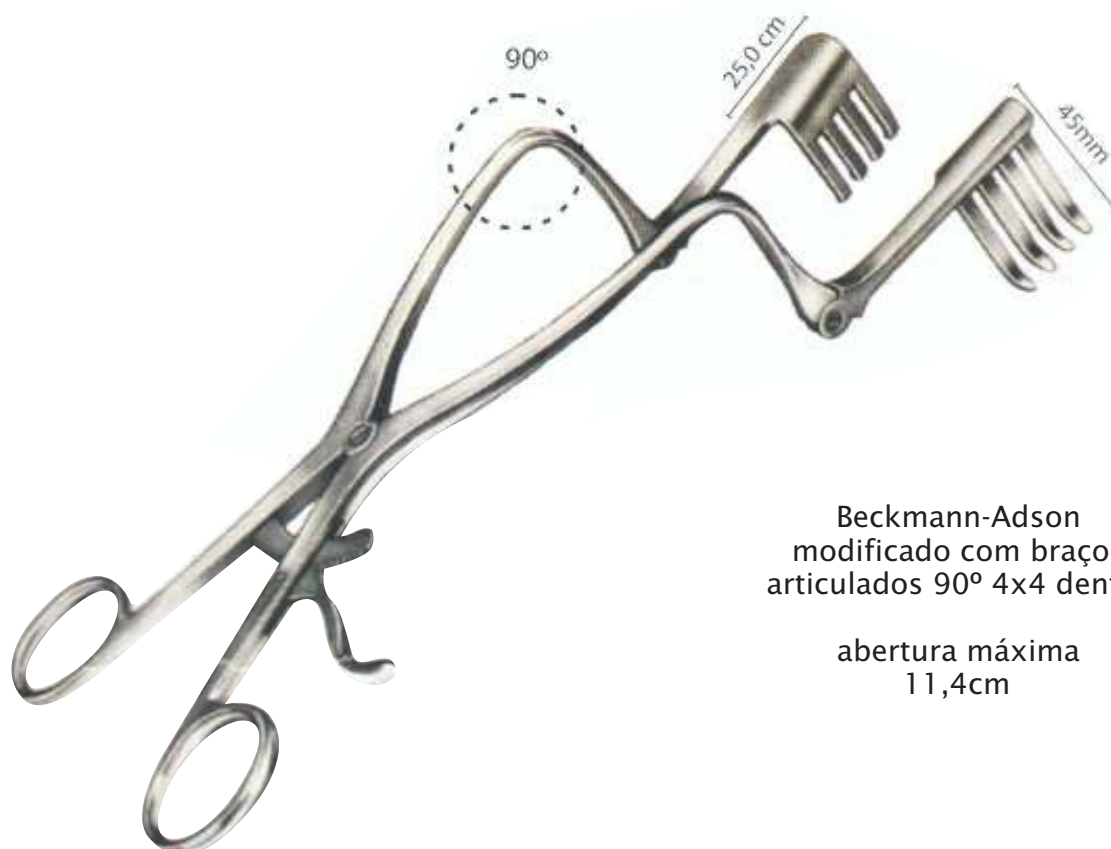

Beckmann-Adson
modificado com braços
articulados 90° 4x4 dentes

abertura máxima
11,4cm

afiado
PH-07.4525

cego
PH-07.4526

Afastadores / Retratores Auto-Retenção Hemilaminectomia

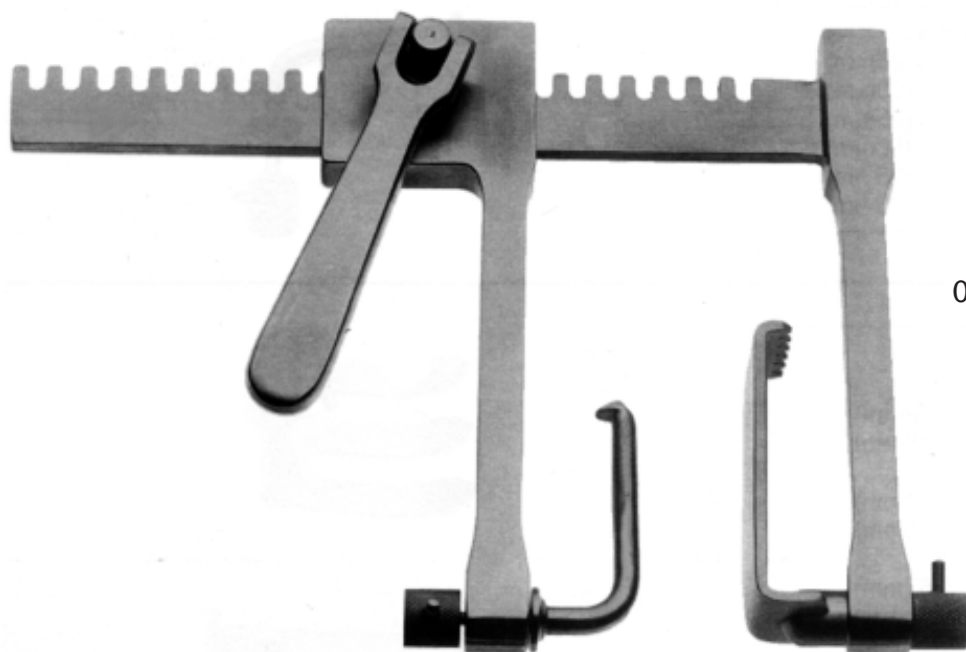

Valin
abertura total 11,4cm
01 gancho 51mm
01 lâmina de 25mmx64mm
PH-07.1400



Scoville com
Cremalheira
01 Gancho
01 Lâmina
PH-07.1510



Lâmina
25x51 mm
PH-07.2551
51x89mm
PH-07.5189
25x82mm
PH-07.2582

As lâminas e ganchos são intercambiáveis e opcionais para uso no chassi dos afastadores.

Afastadores / Retratores Auto-Retenção Hemilaminectomia



Scoville-Haverfield
braços articulados
abertura máxima
17,8cm
PH-07.1530

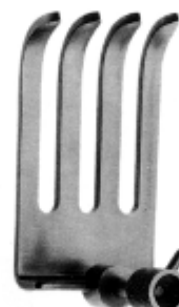

Lâminas opcionais
4 Pinos

29x67mm
PH-07.2967

25x89mm
PH-07.2589

38x41mm
PH-07.3841

44x67mm
PH-07.4467



Lâmina Scoville

25x64mm
PH-07.2564



Ganchos Scoville para
hemilaminectomia
profundidade

38mm
PH-07.1538

51mm
PH-07.1551

70mm
PH-07.1570

76mm
PH-07.1576

As lâminas e ganchos são intercambiáveis e opcionais para uso no chassi dos afastadores.

Afastadores / Retratores Auto-Retenção Hemilaminectomia

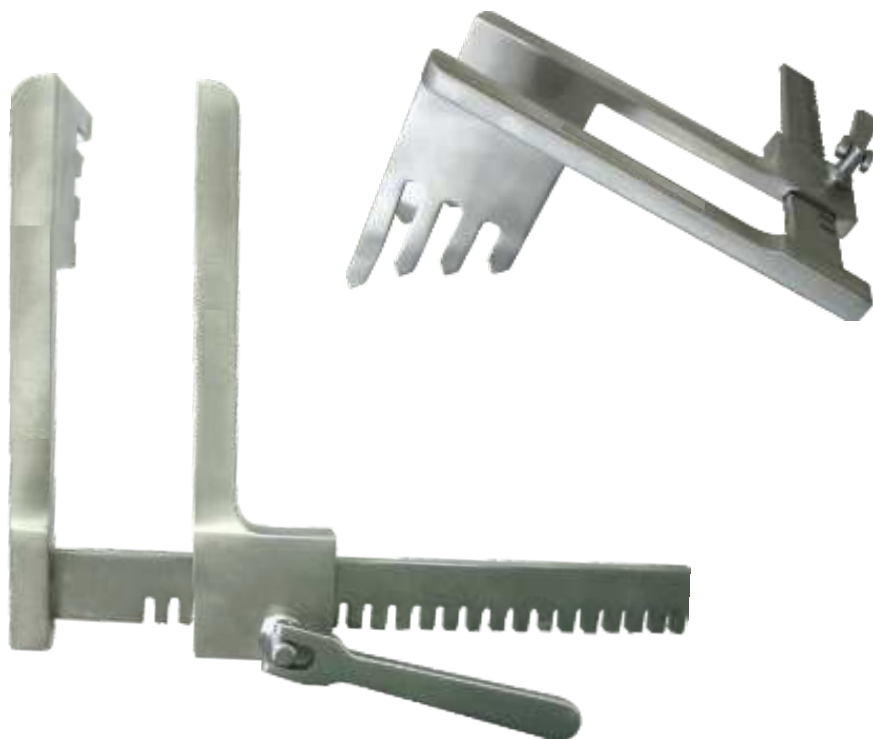

Afastador para
coluna lombar
abertura total
17cm

lâminas fixas
PH-08.1501



Afastador para
coluna lombar articulado
abertura total
17cm

lâminas móveis
PH-08.1502



Lâminas

35x70mm PH-08.3570	50x90mm PH-08.5090
50x80mm PH-08.5080	50x100mm PH-08.5010

Afastadores / Retratores Transversal e Longitudinal para Coluna Cervical / Lombar



Magana

PH-08.9000



Lâminas
60x10mm
com dente
PH-08.6010
sem dente
PH-08.0611



Lâmina
57x15mm
PH-08.1602



Caspar Lombar
16cm
PH-08.1601

Afastadores / Retratores Transversal e Longitudinal para Coluna Cervical

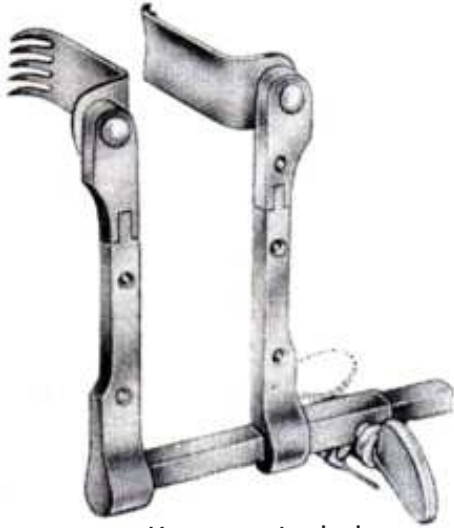

Koros articulado
12cm
com 2 pares de lâminas
(medidas a definir)
PH-08.1697

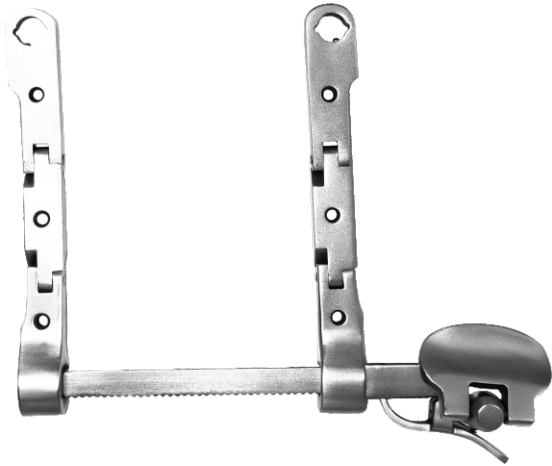

Caspar Counter biarticulado
13cm
com 3 pares de lâminas
(medidas a definir)
PH-08.1705

Lâminas de encaixe rápido



Lâminas Medial

23mmx45mm
PH-08.1682
23mmx50mm
PH-08.1683
23mmx55mm
PH-08.1684
23mmx60mm
PH-08.1685
23mmx65mm
PH-08.1686
23mmx70mm
PH-08.1687



Lâminas Laterais

23mmx45mm
PH-08.1691
23mmx50mm
PH-08.1692
23mmx55mm
PH-08.1693
23mmx60mm
PH-08.1694
23mmx65mm
PH-08.1695
23mmx70mm
PH-08.1696



Lâminas Longitudinais

23mmx45mm
PH-08.1600
23mmx50mm
PH-08.1700
23mmx55mm
PH-08.1701
23mmx60mm
PH-08.1702
23mmx65mm
PH-08.1703
23mmx70mm
PH-08.1704



Lâmina Fenestrada para retirada de Enxerto Ósseo do ilíaco

25mmx50mm
PH-08.2550
25mmx60mm
PH-08.2560



Lâminas Dissectomia

20mmx45mm
PH-08.1604
20mmx50mm
PH-08.1605
20mmx55mm
PH-08.1606
20mmx60mm
PH-08.1607



Lâminas Cegas

20mmx45mm
PH-08.1612
20mmx50mm
PH-08.1613
20mmx55mm
PH-08.1614
20mmx60mm
PH-08.1615



Ejetor de lâminas
PH-07.1254

Afastadores / Retratores Transversal e Longitudinal para Coluna Cervical



Retrator tipo espéculo
com braços fixos

11cm

com 4 lâminas
sem corte

23mmx45mm

23mmx50mm

23mmx55mm

23mmx60mm

PH-08.1698

Retrator tipo espéculo
com braços articulados

15cm

com 4 lâminas
sem corte

23mmx45mm

23mmx50mm

23mmx55mm

23mmx60mm

PH-08.1699



Lâminas
mediais
em titânio



Lâminas
longitudinais
em titânio



Lâminas
mediais



Lâminas
laterais



Lâminas
longitudinais



1



2



3

Janetta
conjunto completo incluindo
1 afastador (1)
1 lâmina curta pequena (4)
2 barras/conector duplo (2)
e simples (3)

PH-08.1706

- | | |
|--|--|
| 1. Apenas o Afastador
PH-08.1707 | 5. Lâmina curta média
PH-08.1711 |
| 2. Barra/conector duplo
PH-08.1708 | 6. Lâmina curta grande
PH-08.1712 |
| 3. Barra/conector simples
PH-08.1709 | 7. Lâmina longa pequena
PH-08.1713 |
| 4. Lâmina curta pequena
PH-08.1710 | 8. Lâmina longa média
PH-08.1714 |
| | 9. Lâmina longa grande
PH-08.1715 |



4

5

6

7

8

9

Afastador / Retrator Cerebral Autostático Leyla-Yasargil



Leyla-Yasargil
auto-estático duplo composto de:
01 base para fixação craniana,
02 braços flexíveis de aço inox,
02 espátulas maleáveis
[PH-09.1710](#)

Foto meramente ilustrativa em uma craniotomia.

Afastador / Retrator Cerebral Autostático Leyla-Yasargil



Cabeçote para fixação dos
braços do Leyla-Yasargil

PH-10.1760



Foto meramente
ilustrativa suporte
espátula



Espátulas medidas opcionais



Conjunto Completo Leyla-Yasargil composto de:

01 Cabeçote para fixação

dos braços Ley

02 Braços flexíveis em aço inox; 02 Espátulas maleáveis; 01 Haste / tirante tubo rígido bi-partido para sustentação constituído de 02 peças para facilitar esterilização e estocagem;

01 Cabeçote móvel fixador para mesa cirúrgica, regulável e acoplável a qualquer mesa cirúrgica.

PH-10.1763

Acessórios e componentes

Base de fixação para
montagem de 02 braços
flexíveis Leyla-Yasargil
no crânio duplo
PH-10.1745



Base de fixação para montagem
de 01 braço flexível Leyla-Yasargil
no crânio simples
PH-10.1740



Braço flexível
de aço inox
PH-10.1735



Suporte de Mesa Cirúrgica para Afastador Retrator Cerebral Autostático Leyla-Yasargil



PH-10.1760

PH-10.1755

PH-10.1765

Conjunto completo do suporte de mesa cirúrgica para Leyla-Yasargil contendo: 01 Haste tirante tubo rígido bi-partido de sustentação, 01 cabeçote de fixação dos braços e 01 cabeçote móvel fixador para mesa cirúrgica regulável.

PH-10.1768



980mm

Haste/tirante tubo rígido bi-partido para sustentação constituído de 02 peças para facilitar esterilização e estocagem

PH-10.1755



Plataforma giratória e móvel para haste do tirante com 01 fixador para braço do Leyla-Yasargil

PH-10.1766

Suporte de Mesa cirúrgica para Afastador Retrator Cerebral Autostático Leyla-Yasargil



Cabeçote móvel fixador
para mesa cirúrgica,
regulável e acoplável a
qualquer mesa cirúrgica
PH-10.1765

Afastadores / Retratores de nervos e raízes



Caspar Baioneta
para raízes nervosas
240mm



6mm
PH-12.2230



8mm
PH-12.2235



10mm
PH-12.2240



Love
reto 5mm
210mm
PH-12.1906



Love
angulado 45° 5mm
210mm
PH-12.1907



Love
angulado 90° 5mm
140mm
PH-12.1908



Baioneta
para raízes nervosas
210mm
PH-12.1909

Afastadores / Retratores para coluna cervical



Cloward cervical articulado 254mm com 01 par de lâminas (escolher medida) Cloward cervical articulado 171mm Caspar cervical biarticulado 171mm

PH-13.1987

PH-13.1989

PH-13.1917

Kit completo com 3 pares de lâmina titânio

PH-13.1988

Kit completo com 3 pares de lâmina titânio

PH-13.1990

Kit completo com 3 pares de lâmina titânio

PH-13.1918



Lâminas medial

15x45mm
PH-13.1945

15x50mm
PH-13.1950

15x55mm
PH-13.1955

15x60mm
PH-13.1960



Lâminas cegas

15x45mm
PH-13.2045

15x50mm
PH-13.2050

15x55mm
PH-13.2055

15x60mm
PH-13.2060

Afastadores / Retratores Expansor de Corpo Vertebral



INGE
Expansor para corpo
vertebral curto
160mm
PH-13.1961



INGE
Expansor para corpo
vertebral longo
270mm
PH-13.1962



Cloward
150mm
PH-13.1963



Cloward
184mm
PH-13.1964

Caspar Esquerdo



Guia de Broca do
Distrator Esquerdo
PH-15.2170



Guia do Parafuso
Fixador do Corpo
Vertebral
PH-15.2180



Chassi Distrator
Vertebral Esquerdo
PH-15.2175



Parafuso Fixador do
Corpo Vertebral

- 12mm
PH-15.2112
- 14mm
PH-15.2114
- 16mm
PH-15.2116



Broca Twist Drill
147mm

- Profundidade
de perfuração 8mm
PH-15.2200

Caspar Direito



Guia de Broca do
Distrator Direito
PH-16.2210



Guia de Parafuso fixador
do corpo vertebral
PH-15.2180



Chassi Distrator
Vertebral Direito
PH-16.2215



Parafuso Fixador do
Corpo Vertebral

- 12mm
PH-15.2112
- 14mm
PH-15.2114
- 16mm
PH-15.2116



Broca Twist Drill
147mm
Profundidade
de perfuração 8mm
PH-15.2200

Chassi Distrator com guia
de broca cervical Caspar
PH-16.2220



Distrator cervical caspar



Kit completo contendo:

- 01 Distrator de corpo vertebral
- 03 Impactores de enxerto ósseo
- 01 Colocador de enxerto
- 01 Dissecador de corpo vertebral
- 01 Guia de broca do distrator
- 06 Parafusos fixadores do corpo vertebral (12mm, 14mm e 16mm)
- 01 Guia do parafuso fixador do corpo vertebral

PH-16.2221



Acessórios distrator cervical caspar



Kit impactador de enxerto ósseo
PH-16.2211

3mm
PH-16.2203

5mm
PH-16.2205

8mm
PH-16.2208



Colocador de enxerto ósseo
210mm
Ponta 15mm
PH-16.2212

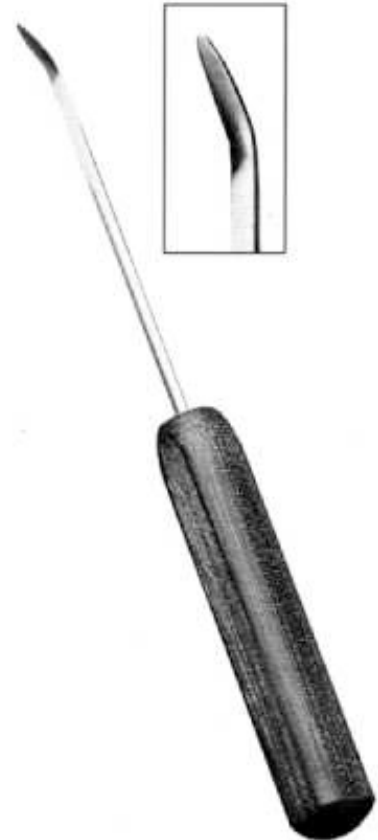

Dissector corpo vertebral largo
PH-16.2213

Afastador / Espéculo Lombar para Microdissectomia



50mm
PH-17.2250

55mm
PH-17.2255

60mm
PH-17.2260

65mm
PH-17.2265

70mm
PH-17.2270

75mm
PH-17.2275

Imagem meramente
ilustrativa



Afastador / Espéculo Lombar para cirurgia Microdissectomia



1/1



1/1

50mm
PH-17.2350

55mm
PH-17.2355

60mm
PH-17.2360

65mm
PH-17.2365

70mm
PH-17.2370

75mm
PH-17.2375

Imagem meramente
ilustrativa





Ejetor de lâminas
PH-07.1254



Kit Completo Caspar inverso
03 lâminas de titânio (escolher tamanhos)
01 ejeter de lâminas
03 espêculos (escolher tamanhos)
e 03 lâminas em aço inox de medidas correspondentes aos espêculos
PH-18.2244



Afastador/Retrator
Caspar inverso
PH-18.2243



Código	Comprimento
PH-18.2245	45mm
PH-18.2250	50mm
PH-18.2255	55mm
PH-18.2260	60mm
PH-18.2265	65mm
PH-18.2207	70mm



Afastador/Retrator Sofield
kit completo com 6 peças
PH-19.4530

Tamanhos/Medidas

45x35x150
PH-19.4535

85x60x180
PH-19.8560

60x45x160
PH-19.6045

100x65x190
PH-19.0065

65x55x170
PH-19.6555

115x75x200
PH-19.1575



Broca/fresa automática Acra-cut
Auto-travante para perfuração e trepanação
70mm



ø9mm infantil/pediátrica
PH-20.2909
ø14mm Adulto
PH-20.1429
ø17mm Adulto
PH-20.1729



Extensão cerebelar de Hudson
102mm
PH-20.2910



Broca perfuradora de Cushing
102mm
ø9mm
PH-20.2911
ø13mm
PH-20.2912
ø16mm
PH-20.2913



Broca de rocha regulável
102mm
ø9mm ø13mm
PH-20.2914 PH-20.2916
ø11mm ø16mm
PH-20.2915 PH-20.2917

Broca de Hudson
102mm



ø9mm
PH-20.2918



ø11mm
PH-20.2919
ø14mm
PH-20.2920



ø9mm
PH-20.2921
ø16mm
PH-20.2922

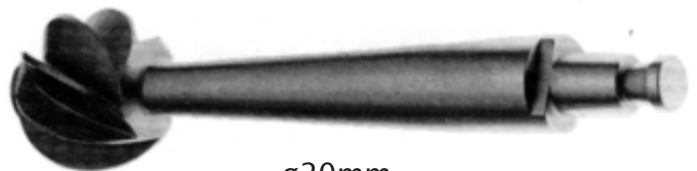

ø20mm
PH-20.2923
ø22mm
PH-20.2924



Broca de Mackenzie
102mm
ø13 mm
PH-20.2925
ø16 mm
PH-20.2926

Brocas de Perfuração Brocas de uso Manual / Trépano / Trefina

Suporte para Broca Twist Drill
PH-14.0484



Trépano manual de Hudson
248mm
PH-20.2480



Broca Twist Drill
70mm

2,0mm
PH-23.2902

2,5mm
PH-23.2925

3,0mm
PH-23.2903



Trefina D'Errico
regulável

25mm
PH-23.2937

38mm
PH-23.2938

51mm
PH-23.2951

65mm
PH-23.2965

Fabricamos sob encomenda medidas especiais

Ponta de aspiração/tubo de sucção Frazier com mandril semi-maleável,
pontas atraumáticas, com anel ou sem anel

medidas/milímetros

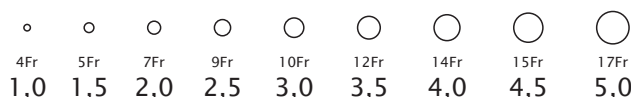

Comprimento x Diâmetro ø

PH-24.8010	80mmx1,0mm	PH-24.9010	90mmx1,0mm	PH-24.1010	100mmx1,0mm
PH-24.8015	80mmx1,5mm	PH-24.9015	90mmx1,5mm	PH-24.1015	100mmx1,5mm
PH-24.8020	80mmx2,0mm	PH-24.9020	90mmx2,0mm	PH-24.1020	100mmx2,0mm
PH-24.8025	80mmx2,5mm	PH-24.9025	90mmx2,5mm	PH-24.1025	100mmx2,5mm
PH-24.8030	80mmx3,0mm	PH-24.9030	90mmx3,0mm	PH-24.1030	100mmx3,0mm
PH-24.8035	80mmx3,5mm	PH-24.9035	90mmx3,5mm	PH-24.1035	100mmx3,5mm
PH-24.8040	80mmx4,0mm	PH-24.9040	90mmx4,0mm	PH-24.1040	100mmx4,0mm
PH-24.8045	80mmx4,5mm	PH-24.9045	90mmx4,5mm	PH-24.1045	100mmx4,5mm
PH-24.8050	80mmx5,0mm	PH-24.9050	90mmx5,0mm	PH-24.1050	100mmx5,0mm
PH-24.1110	110mmx1,0mm	PH-24.1210	120mmx1,0mm	PH-24.1310	130mmx1,0mm
PH-24.1115	110mmx1,5mm	PH-24.1215	120mmx1,5mm	PH-24.1315	130mmx1,5mm
PH-24.1120	110mmx2,0mm	PH-24.1220	120mmx2,0mm	PH-24.1320	130mmx2,0mm
PH-24.1125	110mmx2,5mm	PH-24.1225	120mmx2,5mm	PH-24.1325	130mmx2,5mm
PH-24.1130	110mmx3,0mm	PH-24.1230	120mmx3,0mm	PH-24.1330	130mmx3,0mm
PH-24.1135	110mmx3,5mm	PH-24.1235	120mmx3,5mm	PH-24.1335	130mmx3,5mm
PH-24.1140	110mmx4,0mm	PH-24.1240	120mmx4,0mm	PH-24.1340	130mmx4,0mm
PH-24.1145	110mmx4,5mm	PH-24.1245	120mmx4,5mm	PH-24.1345	130mmx4,5mm
PH-24.1150	110mmx5,0mm	PH-24.1250	120mmx5,0mm	PH-24.1350	130mmx5,0mm
PH-24.1410	140mmx1,0mm	PH-24.1510	150mmx1,0mm	PH-24.1610	160mmx1,0mm
PH-24.1415	140mm x1,5mm	PH-24.1515	150mmx1,5mm	PH-24.1615	160mmx1,5mm
PH-24.1420	140mmx2,0mm	PH-24.1520	150mmx2,0mm	PH-24.1620	160mmx2,0mm
PH-24.1425	140mmx2,5mm	PH-24.1525	150mmx2,5mm	PH-24.1625	160mmx2,5mm
PH-24.1430	140mmx3,0mm	PH-24.1530	150mmx3,0mm	PH-24.1630	160mmx3,0mm
PH-24.1435	140mmx3,5mm	PH-24.1535	150mmx3,5mm	PH-24.1635	160mmx3,5mm
PH-24.1440	140mmx4,0mm	PH-24.1540	150mmx4,0mm	PH-24.1640	160mmx4,0mm
PH-24.1445	140mmx4,5mm	PH-24.1545	150mmx4,5mm	PH-24.1645	160mmx4,5mm
PH-24.1450	140mmx5,0mm	PH-24.1550	150mmx5,0mm	PH-24.1650	160mmx5,0mm

Aspirador / Afastador / Descolador para Crânio Coluna Cânulas de Aspiração / Pontas para Aspiração Tubo de Sucção

PH-24.1710 170mmx1,0mm
 PH-24.1715 170mmx1,5mm
 PH-24.1720 170mmx2,0mm
 PH-24.1725 170mmx2,5mm
 PH-24.1730 170mmx3,0mm
 PH-24.1735 170mmx3,5mm
 PH-24.1740 170mmx4,0mm
 PH-24.1745 170mmx4,5mm
 PH-24.1750 170mmx5,0mm

PH-24.1810 180mmx1,0mm
 PH-24.1815 180mmx1,5mm
 PH-24.1820 180mmx2,0mm
 PH-24.1825 180mmx2,5mm
 PH-24.1830 180mmx3,0mm
 PH-24.1835 180mmx3,5mm
 PH-24.1840 180mmx4,0mm
 PH-24.1845 180mmx4,5mm
 PH-24.1850 180mmx5,0mm

PH-24.1910 190mmx1,0mm
 PH-24.1915 190mmx1,5mm
 PH-24.1920 190mmx2,0mm
 PH-24.1925 190mmx2,5mm
 PH-24.1930 190mmx3,0mm
 PH-24.1935 190mmx3,5mm
 PH-24.1940 190mmx4,0mm
 PH-24.1945 190mmx4,5mm
 PH-24.1950 190mmx5,0mm

PH-24.2010 200mmx1,0mm
 PH-24.2015 200mmx1,5mm
 PH-24.2020 200mmx2,0mm
 PH-24.2025 200mmx2,5mm
 PH-24.2030 200mmx3,0mm
 PH-24.2035 200mmx3,5mm
 PH-24.2040 200mmx4,0mm
 PH-24.2045 200mmx4,5mm
 PH-24.2050 200mmx5,0mm

PH-24.2110 210mmx1,0mm
 PH-24.2115 210mmx1,5mm
 PH-24.2120 210mmx2,0mm
 PH-24.2125 210mmx2,5mm
 PH-24.2130 210mmx3,0mm
 PH-24.2135 210mmx3,5mm
 PH-24.2140 210mmx4,0mm
 PH-24.2145 210mmx4,5mm
 PH-24.2150 210mmx5,0mm

PH-24.2210 220mmx1,0mm
 PH-24.2215 220mmx1,5mm
 PH-24.2220 220mmx2,0mm
 PH-24.2225 220mmx2,5mm
 PH-24.2230 220mmx3,0mm
 PH-24.2235 220mmx3,5mm
 PH-24.2240 220mmx4,0mm
 PH-24.2245 220mmx4,5mm
 PH-24.2250 220mmx5,0mm



Aspirador / Afastador / Descolador para Crânio e Coluna Cânulas de Aspiração / Pontas para Aspiração Tubo de Sucção

Ponta de aspiração/tubo de sucção com orifício gota d'água semi-maleável,
pontas atraumáticas para crânio e coluna.

medidas/milímetros

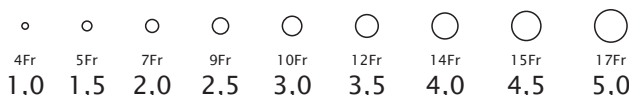

Comprimento x Diâmetro ø

PH-24.8011	80mmx1,0mm	PH-24.9011	90mmx1,0mm	PH-24.1011	100mmx1,0mm
PH-24.8016	80mmx1,5mm	PH-24.9016	90mmx1,5mm	PH-24.1016	100mmx1,5mm
PH-24.8021	80mmx2,0mm	PH-24.9021	90mmx2,0mm	PH-24.1021	100mmx2,0mm
PH-24.8026	80mmx2,5mm	PH-24.9026	90mmx2,5mm	PH-24.1026	100mmx2,5mm
PH-24.8031	80mmx3,0mm	PH-24.9031	90mmx3,0mm	PH-24.1031	100mmx3,0mm
PH-24.8036	80mmx3,5mm	PH-24.9036	90mmx3,5mm	PH-24.1036	100mmx3,5mm
PH-24.8041	80mmx4,0mm	PH-24.9041	90mmx4,0mm	PH-24.1041	100mmx4,0mm
PH-24.8046	80mmx4,5mm	PH-24.9046	90mmx4,5mm	PH-24.1046	100mmx4,5mm
PH-24.8051	80mmx5,0mm	PH-24.9051	90mmx5,0mm	PH-24.1051	100mmx5,0mm
PH-24.1111	110mmx1,0mm	PH-24.1211	120mmx1,0mm	PH-24.1311	130mmx1,0mm
PH-24.1116	110mmx1,5mm	PH-24.1216	120mmx1,5mm	PH-24.1316	130mmx1,5mm
PH-24.1121	110mmx2,0mm	PH-24.1221	120mmx2,0mm	PH-24.1321	130mmx2,0mm
PH-24.1126	110mmx2,5mm	PH-24.1226	120mmx2,5mm	PH-24.1326	130mmx2,5mm
PH-24.1131	110mmx3,0mm	PH-24.1231	120mmx3,0mm	PH-24.1331	130mmx3,0mm
PH-24.1136	110mmx3,5mm	PH-24.1236	120mmx3,5mm	PH-24.1336	130mmx3,5mm
PH-24.1141	110mmx4,0mm	PH-24.1241	120mmx4,0mm	PH-24.1341	130mmx4,0mm
PH-24.1146	110mmx4,5mm	PH-24.1246	120mmx4,5mm	PH-24.1346	130mmx4,5mm
PH-24.1151	110mmx5,0mm	PH-24.1251	120mmx5,0mm	PH-24.1351	130mmx5,0mm
PH-24.1411	140mmx1,0mm	PH-24.1511	150mmx1,0mm	PH-24.1611	160mmx1,0mm
PH-24.1416	140mmx1,5mm	PH-24.1516	150mmx1,5mm	PH-24.1616	160mmx1,5mm
PH-24.1421	140mmx2,0mm	PH-24.1521	150mmx2,0mm	PH-24.1621	160mmx2,0mm
PH-24.1426	140mmx2,5mm	PH-24.1526	150mmx2,5mm	PH-24.1626	160mmx2,5mm
PH-24.1431	140mmx3,0mm	PH-24.1531	150mmx3,0mm	PH-24.1631	160mmx3,0mm
PH-24.1436	140mmx3,5mm	PH-24.1536	150mmx3,5mm	PH-24.1636	160mmx3,5mm
PH-24.1441	140mmx4,0mm	PH-24.1541	150mmx4,0mm	PH-24.1641	160mmx4,0mm
PH-24.1446	140mmx4,5mm	PH-24.1546	150mmx4,5mm	PH-24.1646	160mmx4,5mm
PH-24.1451	140mmx5,0mm	PH-24.1551	150mmx5,0mm	PH-24.1651	160mmx5,0mm
PH-24.1711	170mmx1,0mm	PH-24.1811	180mmx1,0mm	PH-24.1911	190mmx1,0mm
PH-24.1716	170mmx1,5mm	PH-24.1816	180mmx1,5mm	PH-24.1916	190mmx1,5mm
PH-24.1721	170mmx2,0mm	PH-24.1821	180mmx2,0mm	PH-24.1921	190mmx2,0mm
PH-24.1726	170mmx2,5mm	PH-24.1826	180mmx2,5mm	PH-24.1926	190mmx2,5mm
PH-24.1731	170mmx3,0mm	PH-24.1831	180mmx3,0mm	PH-24.1931	190mmx3,0mm
PH-24.1736	170mmx3,5mm	PH-24.1836	180mmx3,5mm	PH-24.1936	190mmx3,5mm
PH-24.1741	170mmx4,0mm	PH-24.1841	180mmx4,0mm	PH-24.1941	190mmx4,0mm
PH-24.1746	170mmx4,5mm	PH-24.1846	180mmx4,5mm	PH-24.1946	190mmx4,5mm
PH-24.1751	170mmx5,0mm	PH-24.1851	180mmx5,0mm	PH-24.1951	190mmx5,0mm

Cânulas de Aspiração / Pontas para Aspiração
Tubo de Sucção / Aspirador Cânula de Sucção Lombar



Adson com mandril
comprimento x diâmetro ø

- 2,0x190mm
PH-25.1920
- 2,5x190mm
PH-25.1925
- 3,0x190mm
PH-25.1930
- 3,5x190mm
PH-25.1935
- 4,0x190mm
PH-25.1940
- 4,5x190mm
PH-25.1945
- 5x190mm
PH-25.1950



Aspirador/Retrator Williams
para micro cirurgia lombar

152mm
ø5mm
PH-25.2235



Frazier graduada
100mm
ø1,5mm
PH-25.1015



Frazier graduada
100mm
ø2,0mm
PH-25.1020



Frazier graduada
100mm
ø2,5mm
PH-25.1025



Frazier graduada
100mm
ø3,0mm
PH-25.1030

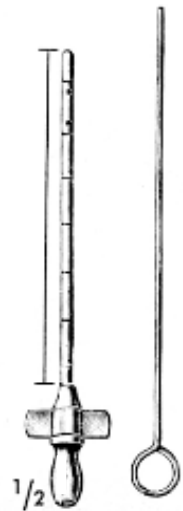

Cânula ventricular de
Frazier com mandril e
aba graduada
70mm
ø2,0mm
PH-25.1040
ø2,5mm
PH-25.1045

Cabos para Lâmina de Bisturi Convencional



Curto
lâmina 3
130mm
PH-25.1210



Longo/Reto
lâmina 3
210mm
PH-25.2103

Longo/angulado
lâmina 3
PH-25.2003

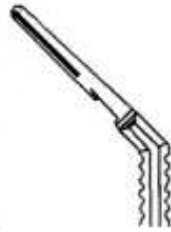

Curto
lâmina 4
130mm
PH-25.1404



Longo/Reto
lâmina 4
210mm
PH-25.2104

Longo/angulado
lâmina 4
PH-25.2004



Cabos para Lâmina de Bisturi Convencional / Baioneta



125mm
curto
lâmina 7k
PH-25.1207



160mm
longo
lâmina 7
PH-25.1607



270mm
reto
longo
PH-25.0027



340mm
baioneta longo
corte vertical
PH-25.0034



200mm
baioneta
corte vertical
PH-14.0901

200mm
baioneta
corte horizontal
PH-25.2010

Cinzel Goivas Osteótomos para Osso

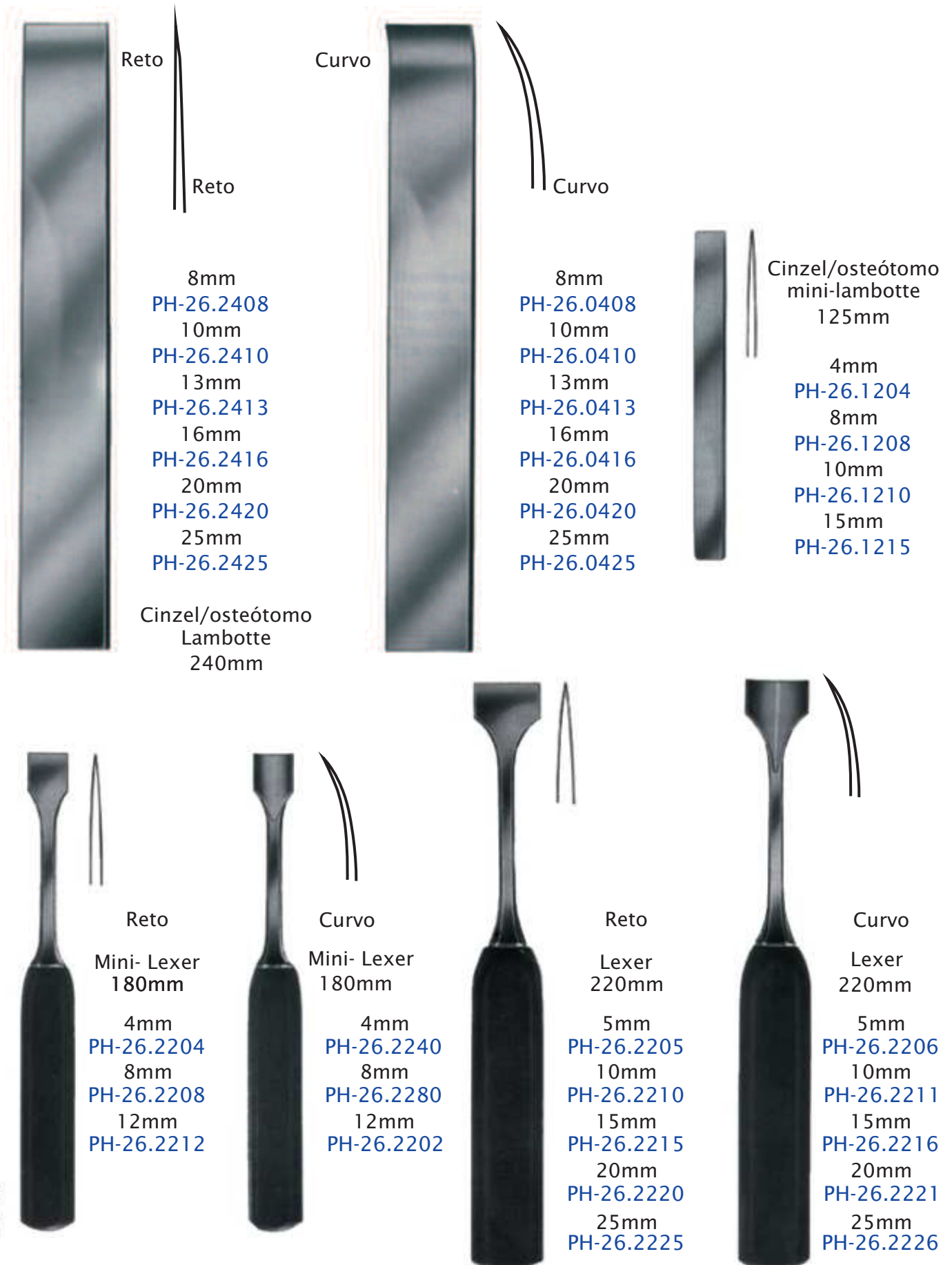

Cinzel Goivas Osteótomos para Osso

Stille

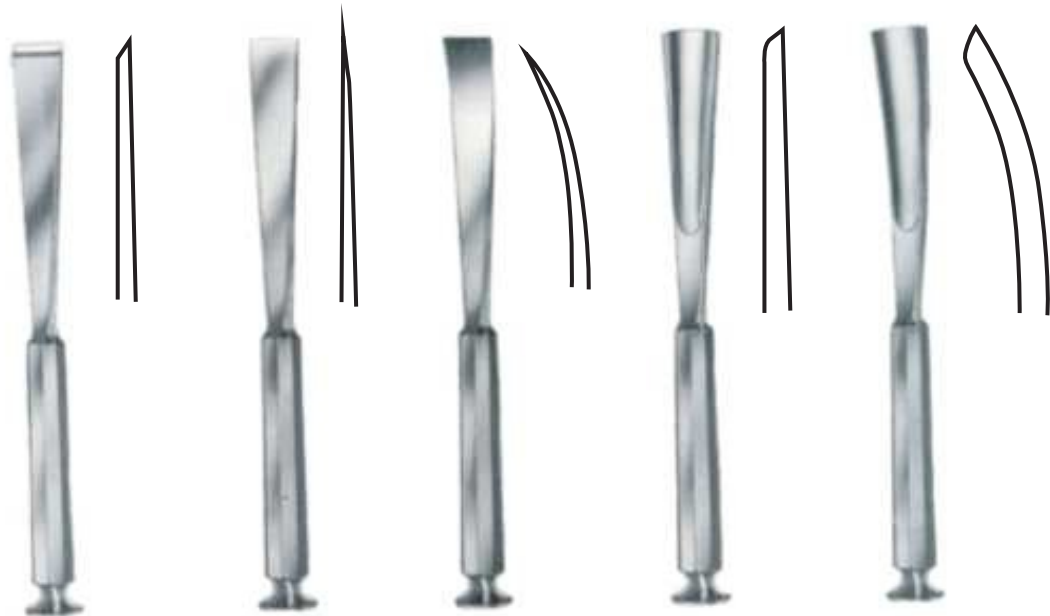

6mm	PH-26.2060	PH-27.2060	PH-28.2060	PH-29.2060	PH-30.2060
8mm	PH-26.2080	PH-27.2080	PH-28.2080	PH-29.2080	PH-30.2080
10mm	PH-26.2010	PH-27.2010	PH-28.2010	PH-29.2010	PH-30.2010
12mm	PH-26.2012	PH-27.2012	PH-28.2012	PH-29.2012	PH-30.2012
15mm	PH-26.2015	PH-27.2015	PH-28.2015	PH-29.2015	PH-30.2015
20mm	PH-26.2020	PH-27.2020	PH-28.2020	PH-29.2020	PH-30.2020
25mm	PH-26.2025	PH-27.2025	PH-28.2025	PH-29.2025	PH-30.2025
30mm	PH-26.2030	PH-27.2030	PH-28.2030	PH-29.2030	PH-30.2030

Hibbs 240mm



6mm	PH-31.2460	PH-32.2460	PH-33.2460	PH-34.2460	PH-35.2460
9mm	PH-31.2490	PH-32.2490	PH-33.2490	PH-34.2490	PH-35.2490
13mm	PH-31.2413	PH-32.2413	PH-33.2413	PH-34.2413	PH-35.2413
16mm	PH-31.2416	PH-32.2416	PH-33.2416	PH-34.2416	PH-35.2416
19mm	PH-31.2419	PH-32.2419	PH-33.2419	PH-34.2419	PH-35.2419
25mm	PH-31.2425	PH-32.2425	PH-33.2425	PH-34.2425	PH-35.2425
32mm	PH-31.2432	PH-32.2432	PH-33.2432	PH-34.2432	PH-35.2432

Cinzel para Osso / Goivas Osteótomos Para Osso



Smith-Petersen
200mm



Reto
16mm
PH-46.2016
19mm
PH-46.2019
25mm
PH-46.2500
30mm
PH-46.2030



Curvo
16mm
PH-46.2017
19mm
PH-46.2020
25mm
PH-46.2026
30mm
PH-46.2034



Cinzel de Killian
Claus canulado
185mm
PH-25.2018



Cloward
240mm

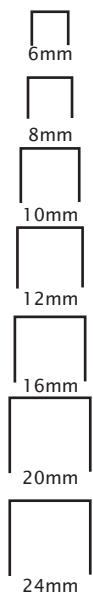

PH-46.2406
PH-46.0824
PH-46.2410
PH-46.2412
PH-46.2416
PH-46.2420
PH-46.2424



PH-46.2460
PH-46.2480
PH-46.2401
PH-46.2421
PH-46.2461
PH-46.2402
PH-46.2442



Reto
5mm
PH-46.2050
8mm
PH-46.2080



Curvo
5mm
PH-46.2051
8mm
PH-46.2081

Cinzel Hoke
200mm

Cinzel / Instrumentos Nasais Transfenoidal



Freer
160mm
PH-26.1640



Freer
160mm
PH-26.1641



Freer
160mm
PH-26.1660



Ballenger
160mm
PH-26.1642



Killian
160mm
PH-26.1643



Killian-Claus
160mm
PH-26.1644



4mm
PH-26.1840



7mm
PH-26.1870



9mm
PH-26.1890



12mm
PH-26.1812

Cottle
180mm



Cottle
180mm
PH-26.1813



Cottle
160mm
PH-26.1618



reto
4mm
PH-26.1805
6mm
PH-26.1806
8mm
PH-26.1808
10mm
PH-26.1810
12mm
PH-26.1818

Cottle
180mm



curvo
4mm
PH-26.1804
7mm
PH-26.1807
9mm
PH-26.1809
12mm
PH-26.1218

Curetas de Fusão Espinhal Curetas para Osso



Caspar
230mm



Cureta reta
3,6mm
PH-39.2536



Cureta reta
4,4mm
PH-39.2544



Cureta reta
5,2mm
PH-39.2552



Cureta reta
6,0mm
PH-39.2560



Caspar
230mm



Cureta angulada
3,6mm
PH-39.2561



Cureta angulada
4,4mm
PH-39.2562



Cureta angulada
5,2mm
PH-39.2563



Cureta angulada
6,0mm
PH-39.2564



Caspar
ângulo reverso
230mm

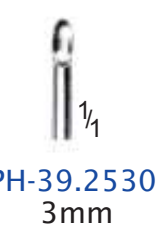

PH-39.2530
3mm

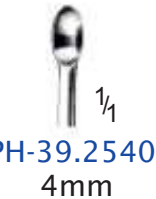

PH-39.2540
4mm

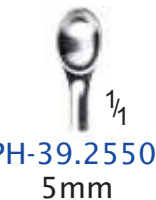

PH-39.2550
5mm

Ponta Concha Oval



Cureta de Simon
240mm



ponta reta



ponta angulada

Figura	Reta	Referência	Angulada	Referência
0000	2,8mm	PH-39.2428	2,8mm	PH-39.2417
000	3,6mm	PH-39.2436	3,6mm	PH-39.2418
00	4,4mm	PH-39.2444	4,4mm	PH-39.2419
0	5,2mm	PH-39.2452	5,2mm	PH-39.2420
1	6,8mm	PH-39.2468	6,8mm	PH-39.2421
2	8,5mm	PH-39.2485	8,5mm	PH-39.2422
3	10,0mm	PH-39.2410	10,0mm	PH-39.2423
4	11,5mm	PH-39.2411	11,5mm	PH-39.2424
5	13,0mm	PH-39.2413	13,0mm	PH-39.2425

Curetas de Fusão Espinhal Curetas para Osso



Curetas de Fusão Espinhal Curetas para Osso

Ponta concha redonda



Volkmann
170mm



Volkmann
270mm



Figura	Reta	Referência	Angulada	Referência
0000	2,8mm	PH-39.1775	2,8mm	PH-39.1785
000	3,6mm	PH-39.1776	3,6mm	PH-39.1786
00	4,4mm	PH-39.1777	4,4mm	PH-39.1787
0	5,2mm	PH-39.1778	5,2mm	PH-39.1788
1	6,8mm	PH-39.1779	6,8mm	PH-39.1789
2	8,5mm	PH-39.1780	8,5mm	PH-39.1790
3	10,0mm	PH-39.1781	10,0mm	PH-39.1791
4	11,5mm	PH-39.1782	11,5mm	PH-39.1792

Figura	Reta	Referência
000	3,6mm	PH-39.2701
00	4,4mm	PH-39.2702
0	5,2mm	PH-39.2703
1	6,8mm	PH-39.2704
2	8,5mm	PH-39.2705
3	10,0mm	PH-39.2706
4	11,5mm	PH-39.2707

Curetas de Fusão Espinhal Curetas para Osso

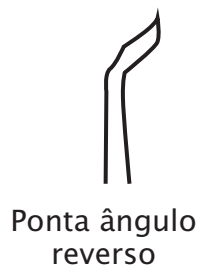

Epstein
200mm



Spinal
200mm

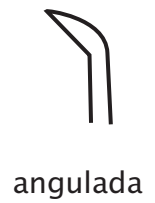

Spinal
200mm

Figura	Epstein Ângulo Reverso	Referência	Spinal Reta	Referência	Spinal Angulada	Referência
000	3,6mm	PH-39.2001	3,6mm	PH-39.2010	3,6mm	PH-39.2019
00	4,4mm	PH-39.2002	4,4mm	PH-39.2011	4,4mm	PH-39.2020
0	5,2mm	PH-39.2003	5,2mm	PH-39.2012	5,2mm	PH-39.2021
1	6,8mm	PH-39.2004	6,8mm	PH-39.2013	6,8mm	PH-39.2022
2	8,5mm	PH-39.2005	8,5mm	PH-39.2014	8,5mm	PH-39.2023
3	10,0mm	PH-39.2006	10,0mm	PH-39.2015	10,0mm	PH-39.2024
4	11,5mm	PH-39.2007	11,5mm	PH-39.2016	11,5mm	PH-39.2025
5	13,0mm	PH-39.2008	13,0mm	PH-39.2017	13,0mm	PH-39.2026

Curetas Especiais / Via Lateral Cirurgia Tóraco Lombor Transforaminal



Spinal reta
modelo Sisco
230mm



Reta

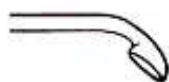

Angulada 40°



Angulada 90°



Angulo reverso

Fig.

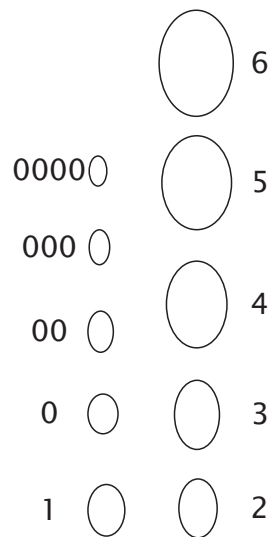

Medidas

Comprimento x Largura	
0000	2,3x3,5mm
000	2,8x3,9mm
00	3,0x4,6mm
0	3,3x5,0mm
1	4,1x6,9mm
2	5,0x7,5mm
3	5,5x8,4mm
4	7,5x10,9mm
5	8,8x12,5mm
6	9,9x14,5mm

Figura	Reta	Angulada 40°	Angulada 90°	Ang. Reverso p/ Cima
0000	PH-39.2325	PH-39.2335	PH-39.2345	PH-39.2359
000	PH-39.2326	PH-39.2336	PH-39.2346	PH-39.2360
00	PH-39.2327	PH-39.2337	PH-39.2347	PH-39.2361
0	PH-39.2328	PH-39.2338	PH-39.2348	PH-39.2362
1	PH-39.2329	PH-39.2339	PH-39.2349	PH-39.2363
2	PH-39.2330	PH-39.2340	PH-39.2350	PH-39.2364
3	PH-39.2331	PH-39.2341	PH-39.2355	PH-39.2365
4	PH-39.2332	PH-39.2342	PH-39.2356	PH-39.2366
5	PH-39.2333	PH-39.2343	PH-39.2357	PH-39.2367
6	PH-39.2334	PH-39.2344	PH-39.2358	PH-39.2368

Curetas de Fusão Espinhal Curetas para Osso



Fig. 00
3,0x4,6mm
PH-39.1701



Fig. 0
3,3x5,0mm
PH-39.1702



Fig. 1
4,1x6,9mm
PH-39.1703



Fig. 2
5,0x7,5mm
PH-39.1704
Ponta Oval



Fig. 00
3,0x3,0mm
PH-39.1705



Fig. 0
3,3x3,5mm
PH-39.1706



Fig. 1
4,1x4,0mm
PH-39.1707



Fig. 2
5,0x5,0mm
PH-39.1708
Ponta Redonda



Fig. 000 2,8x3,9mm
PH-39.2101



Fig. 00 3,0x4,6mm
PH-39.2102



Fig. 0 3,3x5,0mm
PH-39.2103



Fig. 1 4,1x6,9mm
PH-39.2104



Fig. 2 5,0x7,5mm
PH-39.2105



Fig. 3 5,5x8,4mm
PH-39.2106





Fig. 4 7,5x10,9mm
PH-39.2107

Ponta reta

Willinger
170mm



Ponta redonda

Ponta oval

Spinal
ponta dupla
210mm

Curetas Especiais / Via Lateral Cirurgia Tóraco Lombor Transforaminal



Spinal
em Baioneta
Modelo Sisco
230mm



Fig.

0000 ○

000 ○

00 ○

0 ○

Medidas

Comprimento x Largura	
0000	2,3x3,5mm
000	2,8x3,9mm
00	3,0x4,6mm
0	3,3x5,0mm



Spinal
em curva
Modelo Sisco
200mm

Figura	Reta	Angulada 40°	Angulada 90°	Ang. Reverso p/ Cima	Ang. Reverso p/ Baixo
0000	PH-39.2369	PH-39.2373	PH-39.2377	PH-39.2381	PH-39.2385
000	PH-39.2370	PH-39.2374	PH-39.2378	PH-39.2382	PH-39.2386
00	PH-39.2371	PH-39.2375	PH-39.2379	PH-39.2383	PH-39.2387
0	PH-39.2372	PH-39.2376	PH-39.2380	PH-39.2384	PH-39.2388



Spinal Reta
230mm

Fig.

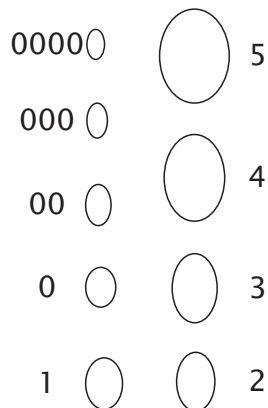

Medidas

Comprimento x Largura	
0000	2,3x3,5mm
000	2,8x3,9mm
00	3,0x4,6mm
0	3,3x5,0mm
1	4,1x6,9mm
2	5,0x7,5mm
3	5,5x8,4mm
4	7,5x10,9mm
5	8,8x12,5mm

Figura	Reta	Angulada 40°
0000	PH-49.2442	PH-39.4035
000	PH-39.2839	PH-39.4039
00	PH-39.3046	PH-39.4046
0	PH-39.3350	PH-39.4050
1	PH-39.4169	PH-39.4069
2	PH-39.5075	PH-39.4075
3	PH-39.5584	PH-39.4084
4	PH-39.7510	PH-39.4010
5	PH-39.8812	PH-39.4012

Curetas Fenestradas



em forma
4mmx8mm
PH-39.2548



em forma
5mmx8mm
PH-39.2558



Caspar reta
ponta semi-angulada
250mm

com dente com dente
4mmx8mm 5mmX8mm
PH-39.2549 PH-39.4559



em forma
3mmx7mm
PH-39.2737



em forma
4 mmx7mm
PH-39.2747



Caspar angulada
ponta fortemente angulada
270mm

com dente com dente
3mmx7mm 4mmx7mm
PH-39.2738 PH-39.2748

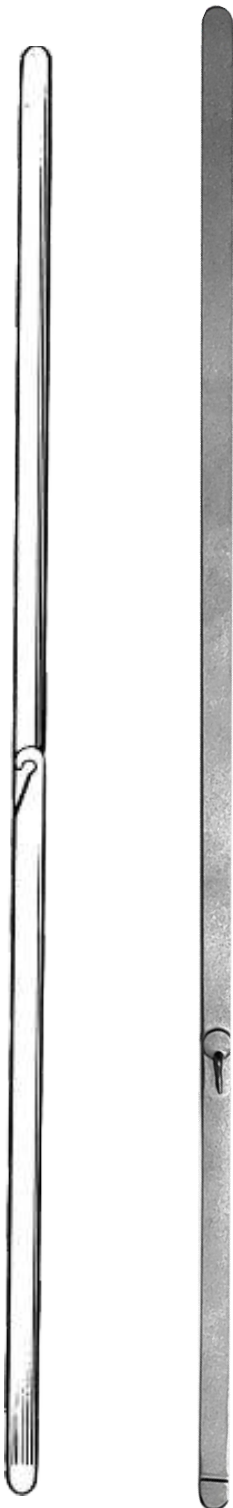

duplo
PH-41.0279
279mm

simples
PH-41.3050
305mm

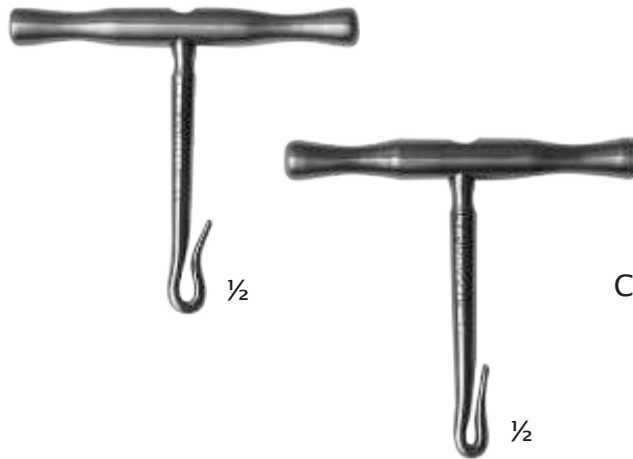

Cabo de serra de
Gigli 51 mm
(PAR)
PH-41.5101

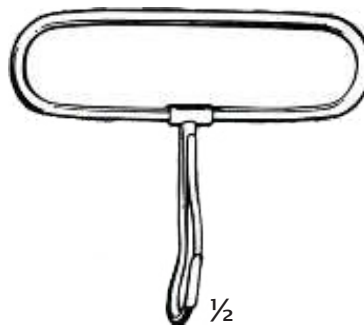

Cabo de serra de Gigli
modelo Strully Gigli com
dispositivo de travamento
PH-41.8001



Serra de Gigli
em aço inox
300mm
PH-41.0300
400mm
PH-41.0400
500mm
PH-41.0500



condutor Guia de Serra de Gigli
modelo de Martel maleável

Descoladores / Elevadores Periosteo Instrumentos para Cirurgia de Coluna e Quadril

Descolador de Cobb
31,5mm

Lâmina
cega 10mm
PH-42.2710

Lâmina
cega 15mm
PH-42.2715

Lâmina
cega 20mm
PH-42.2720

Lâmina
cega 22mm
PH-42.2831

Lâmina
cega 25mm
PH-42.2725

Lâmina
cega 30mm
PH-42.2730

Lâmina
cega 32mm
PH-42.2832

Lâmina
cega 35mm
PH-42.2735



Lâmina cortante
10mm
PH-42.2742

Lâmina cortante
15mm
PH-42.2743

Lâmina cortante
20mm
PH-42.2744

Lâmina cortante
22mm
PH-42.2833

Lâmina cortante
25mm
PH-42.2745

Lâmina cortante
30mm
PH-42.2746

Lâmina cortante
32mm
PH-42.2834

Lâmina cortante
35mm
PH-42.2747

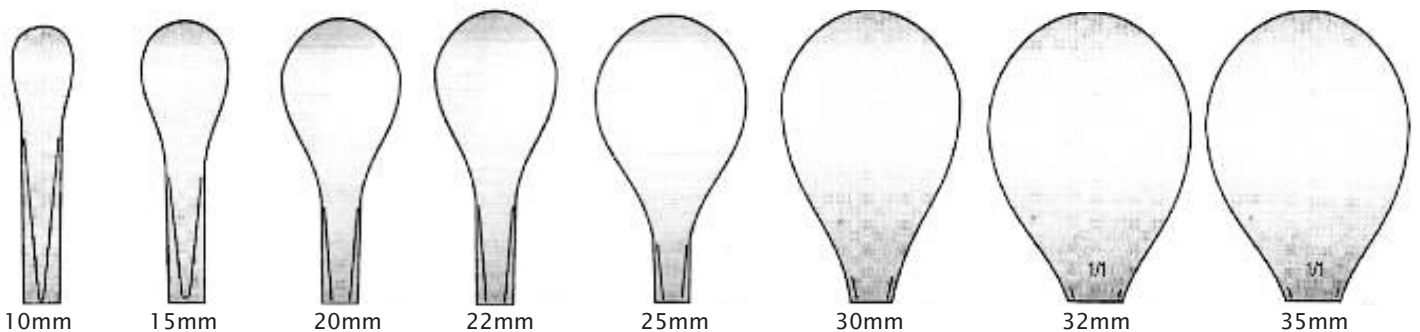



Descolador
Cobb reto estreito
280mm
PH-42.2840



Descolador
Cobb curvo suave
280mm
5mm PH-42.2841
10mm PH-42.2842
15mm PH-42.2843



Descolador
Cobb curvo forte
280mm
5mm PH-42.2844
10mm PH-42.2845
15mm PH-42.2846



Descolador
Cobb curvo reverso
280mm
PH-42.2847

Descoladores / Elevadores Periosteo Instrumentos para Cirurgia de Coluna e Quadril



10mm



15mm



20mm



25mm



30mm



Descolador
Lexer 279mm

semi curvo

10mm

PH-42.2731

15mm

PH-42.2732

20mm

PH-42.2733

25mm

PH-42.2734

30mm

PH-42.2703



Descolador
Lexer curvo
250mm

5mm

PH-42.2543

10mm

PH-42.2544

15mm

PH-42.2545

Descolador
Lexer reto
250mm

5mm

PH-42.2540

10mm

PH-42.2541

15mm

PH-42.2542



Descolador Lexer
280mm

5mm

PH-42.2837

10mm

PH-42.2838

15mm

PH-42.2839

Descoladores / Elevadores Periosteo Instrumentos para Cirurgia de Coluna e Quadril

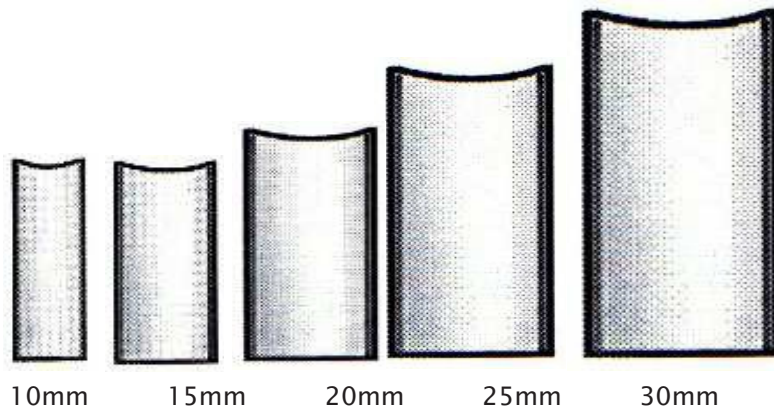

Descolador
Lexer fortemente curvo
285mm

10mm
PH-42.2810

15mm
PH-42.2815

20mm
PH-42.2820

25mm
PH-42.2825

30mm
PH-42.2830

1/2



Descolador Lexer curvo
275mm

9mm
PH-42.2709

16mm
PH-42.2716

20mm
PH-42.2741

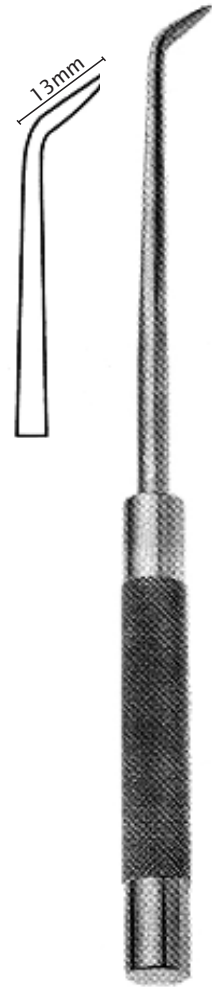

Osteótomo Spinal
Annular 220mm
PH-60.2201



Osteótomo spinal
241mm

reto	curvo
6mm PH-60.2406	6mm PH-60.2460
8mm PH-60.2408	8mm PH-60.2480
10mm PH-60.2410	10mm PH-60.2401
15mm PH-60.2415	15mm PH-60.2405
20mm PH-60.2420	20mm PH-60.2402

Descoladores / Elevadores Extra Longo



Descolador Karlin
340mm
10mm
PH-42.3310
15mm
PH-42.3315
20mm
PH-42.3320
25mm
PH-42.3325
30mm
PH-42.3330
35mm
PH-42.3335

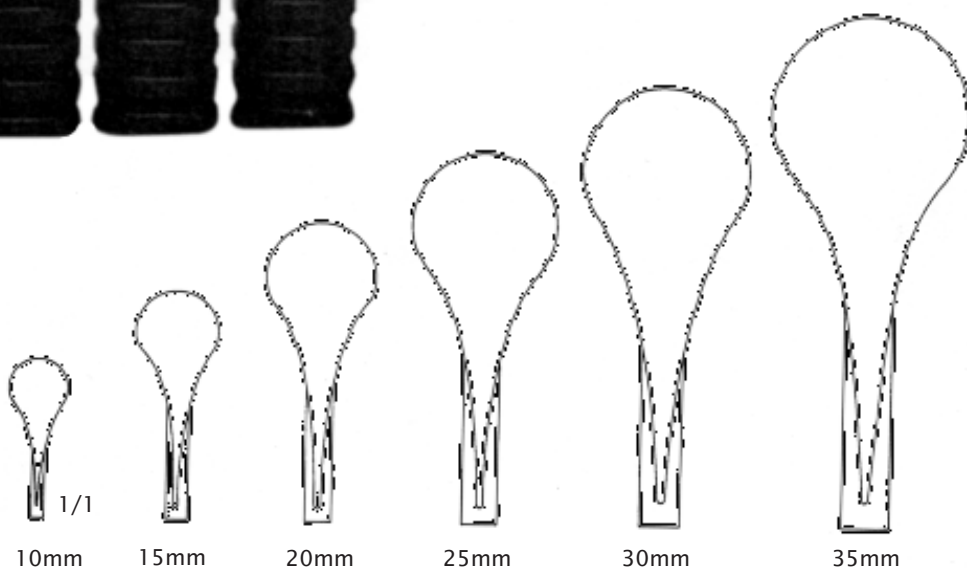

Adson reto
165mm
ponta quadrada 8mm
mod. 1
[PH-43.1608](#)



Adson cuvo
165mm
ponta semi afiada 6mm
mod. 2
[PH-43.1606](#)



Adson curvo
165mm
ponta romba 6mm
mod. 3
[PH-43.1607](#)



Adson reto
165mm
ponta reta 8mm
mod. 4
[PH-43.1609](#)



Cushing reto
216mm
ponta redonda afiada 6mm
[PH-43.2106](#)



Cushing
191mm
ponta redonda afiada 6mm
[PH-43.1906](#)



Cushing Little Joker
152mm
ponta estreita 6mm
PH-44.1526



Cushing Little Joker
191mm
ponta estreita 6mm
PH-44.1916



Cushing
184mm
ponta arredondada 16mm
PH-44.1841



Cushing
184mm
ponta reta 16mm
PH-44.1842



Elevador periósteo forte
203mm
lâmina 5mm
PH-44.2035



Elevador periósteo forte
203mm
largura lâmina 12mm
PH-44.2012



Elevador Periósteo Forte
203mm
lâmina 6,4mm
PH-44.2064



Descoladores / Dissectores Elevadores para Duramater / Cinzel



Freer
210mm
PH-43.2101



Freer
222mm
PH-43.2201



Freer
195mm
PH-54.1553
230mm
PH-54.2300



Davis
240mm
PH-43.2405



afiado/agudo
cortante
210mm
PH-43.2204



cego/rombo
220mm
PH-43.2202



1/1



Woodson
250mm
PH-43.2501

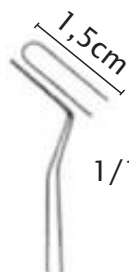

1/1



1/1



Yasargil
195mm
PH-54.1955



230mm
PH-54.2301



Descoladores / Dissectores Elevadores para Duramater / Cinzel



Milligan
210mm
PH-43.2104



Olivercrona
180mm
PH-43.1802



Olivercrona
195mm
PH-43.1951
240mm
PH-43.2406



Olivercrona
195mm
PH-43.1952
230mm
PH-43.1954

Olivercrona
240mm
PH-43.2404



Olivercrona longo
290mm
PH-43.2901



Olivercrona
240mm



suavemente
curvo



fortemente
curvo

suavemente curvo
PH-43.2403
fortemente curvo
PH-43.2402



Descolador/Afastador
para duramater coluna
225mm
PH-43.2689



Descoladores / Dissectores Elevadores para Duramater / Cinzel

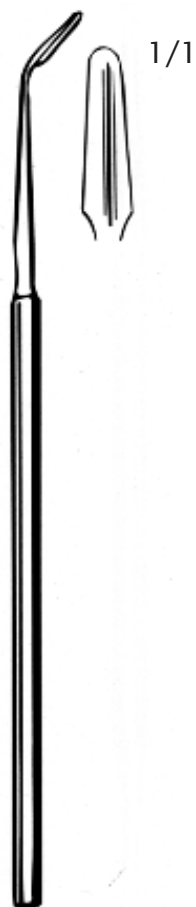

Frazier
165mm
PH-43.1610



165mm

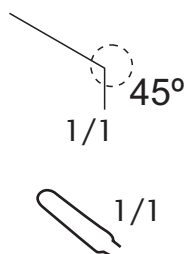

Hoehn
PH-43.1613

1/1

Hoehn
PH-43.1614



Prof. Gusmão
180mm
PH-43.1801

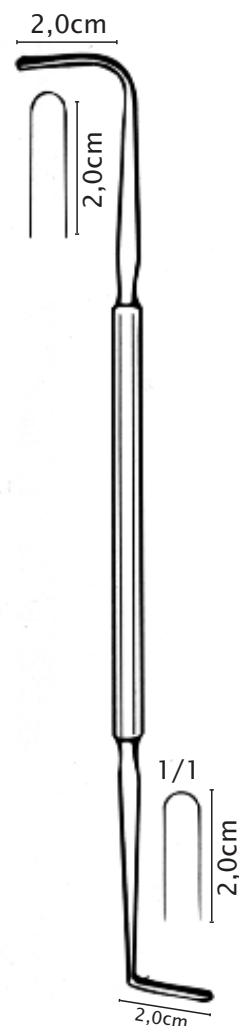

Prof. Gusmão
240mm
PH-43.2401



Cego
PH-54.1951

Afiado
PH-54.1952

Cottle
195mm



Lempert
curvo
180mm
PH-54.1801



Lempert
meio curvo
180mm
PH-54.1802

Descoladores / Dissectores Elevadores para Duramater e Periosteio



1/1

Sachs
210mm
PH-43.2102



1/1

Sachs
210mm
PH-43.2103



1/1

Sachs
210mm
PH-43.2105
237mm
PH-43.2370



François
200mm
PH-43.2001

Elevador crego periosteal ponta romba
200mm



PH-60.2000

8mm
PH-60.2000



PH-60.2001

8mm
PH-60.2001

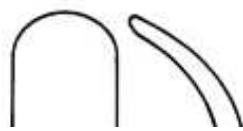

PH-60.2002

14mm
PH-60.2002





Tonnis
250mm
PH-43.2502



Horsley
200mm
PH-43.2002



Love-Adson
160mm
PH-43.1615



1/1
cortante



1
Penfield's n° 1
203mm
PH-43.2031

afiada/cortante



2
cureta em
concha
afiada

Penfield's n° 2
197mm
PH-43.1972

afiada/cortante



3
cureta em
concha
afiada

Penfield's n°3
197mm
PH-43.1973

afiada/cortante



4
ponta curva
suave cega

Penfield's n°4
197mm
PH-43.2904



5
Penfield's n°5
290mm
PH-43.2905



Espéculo Mathieu
Trivalve
ø15xø18x70mm
PH-26.1600

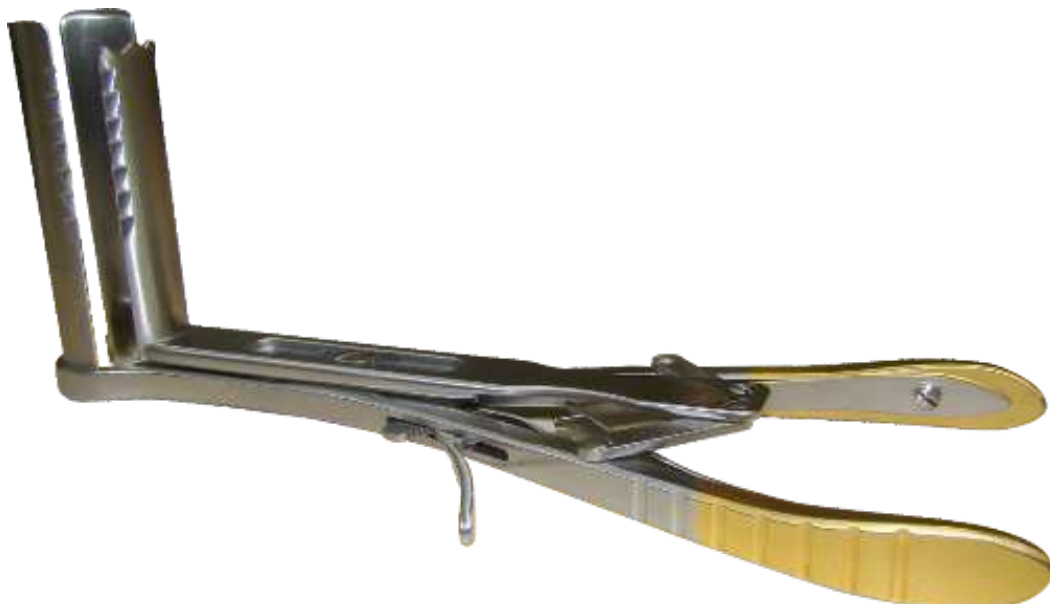



Cottle
150mm



75mm
PH-36.1575



95mm
PH-36.1595



Espéculo nasal
150mm

80mm
PH-38.8081

90mm
PH-38.9091

100mm
PH-38.1001



Killian
150mm

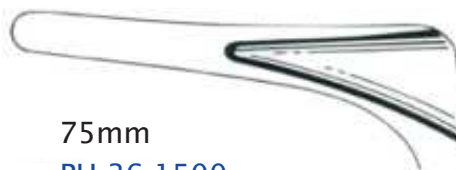

75mm
PH-36.1500



95mm
PH-36.1505

Espéculo nasal delicado com
acesso endoscópico

70mm
PH-38.7010
80mm
PH-38.9010
100mm
PH-38.1010



Espéculo nasal
delicado

70mm
PH-38.7070
80mm
PH-38.8080
90mm
PH-38.9090
100mm
PH-38.1000



Espéculo de
Cushing

70mm
PH-38.7015
90mm
PH-38.9015



Espátulas Maleáveis Cerebrais / Facas Giratórias Instrumentos Nasais / Elevadores de Septo



Espátula
180mm

7x9mm
PH-12.0709
11x13mm
PH-12.1113
15x18mm
PH-12.1518
18x22mm
PH-12.1802



Espátula
180mm

6mm
PH-12.1806
8mm
PH-12.1808
10mm
PH-12.1810
12mm
PH-12.1812
14mm
PH-12.1814
16mm
PH-12.1816
18mm
PH-12.1818
20mm
PH-12.1820
22mm
PH-12.1822
24mm
PH-12.1824



Espátula
200mm

14mm
PH-12.2014
18mm
PH-12.2018
20mm
PH-12.2020



Faca Giratória
Ballenger reta
200mm

3mm
PH-53.2003
4mm
PH-53.2004
5mm
PH-53.2005



Faca Giratória
Ballenger Baioneta
200mm

3mm
PH-53.2007
4mm
PH-53.2008
5mm
PH-53.2009

Adson 197mm
profundidade 5mm 0,9mm
PH-47.1975



Cushing
190mm

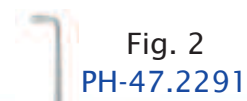
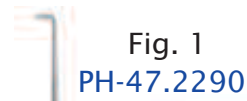

Cushing
280mm

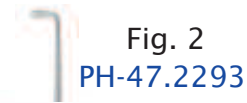
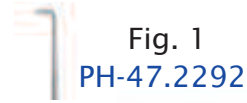

Dandy 219mm
ponta 3,0x1,5mm
PH-47.2190



Graham 178mm
ponta 4,0x1,0mm
PH-47.1780



Hoer 222mm
ponta 7,0x1,0mm
PH-47.2220



Malis 184mm ponta com bola



3mm
PH-47.1843

Malis 184mm ponta sem bola

3mm

PH-47.1834



Ganchos Sonda Ganchos para Nervos



Cushing
140mm ø2mm
PH-47.1402

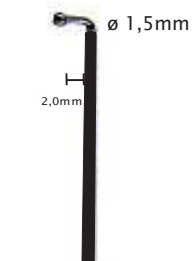

Frazier
127mm ø2mm
PH-47.1272



Lahey 157mm
PH-47.1570

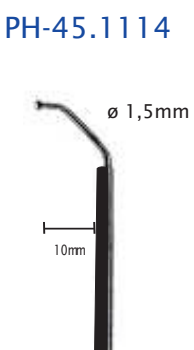

Crile 200mm
PH-47.2001



Gillies 180mm
PH-47.1802



Ganchos sonda para exploração
de raízes nervosas isoladas
250mm

Goivas Ósseas Dupla Ação



Cizalha
Stille-Liston

reta
230mm
PH-46.2670

curva
230mm
PH-46.2671

angulada 90°
270mm
PH-46.2672

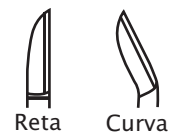
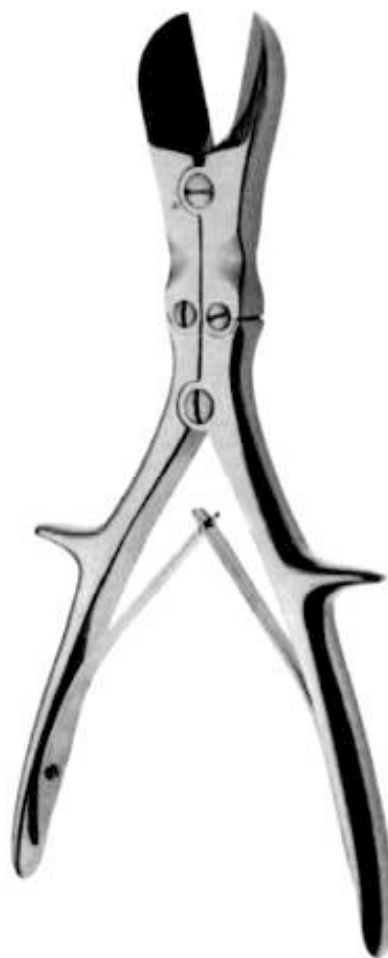

Cizalha
Liston

reta
270mm
PH-46.2700

curva
230mm
PH-46.2300



Cizalha
Semb
PH-46.2426



Cizalha
Liston-Key
(Horsley)
PH-46.2674

Goivas Ósseas Simples Ação



1/1  boca/mandíbula
8mm

Adson cranial
203mm
PH-46.2038



1/1  boca/mandíbula
5mm

Bacon cranial
197mm
PH-46.1975



Sybert
360mm
PH-46.3600

Goivas Ósseas Dupla Ação



Semb
265mm
curva
PH-46.2650

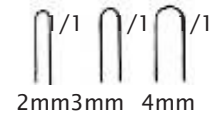

Echlin
230mm
angulada
2mm
PH-46.2302
3mm
PH-46.2303
4mm
PH-46.2304



Largura da mandíbula
mordedura

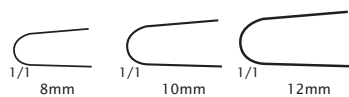

Stille-Luer
229mm

reta
8mm
PH-46.2108
10mm
PH-46.2110
12mm
PH-46.2112

curva
8mm
PH-46.2180
10mm
PH-46.2101



Largura da mandíbula
mordedura

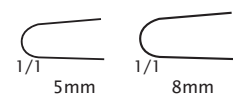

Stille
229mm

angulada
5mm
PH-46.2295
angulada
8mm
PH-46.2298

Goivas Ósseas Simples Ação



Olivercrona
200mm
PH-46.2039

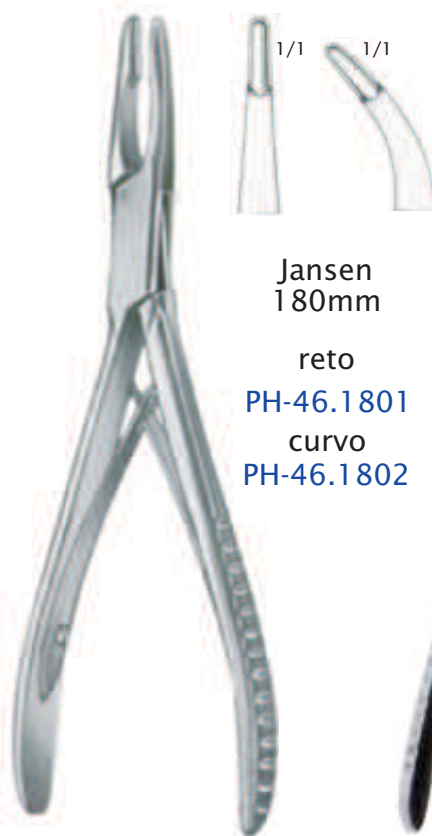

Jansen
180mm
reto
PH-46.1801
curvo
PH-46.1802

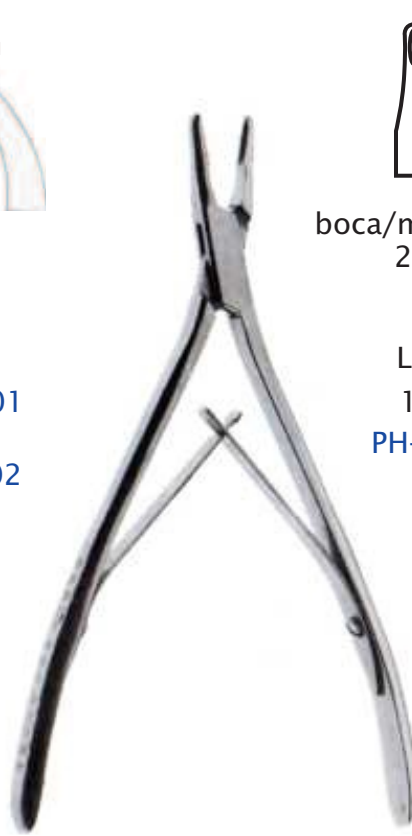

boca/mandíbula
2mm

Lempert
156mm
PH-46.1562



Jansen Baioneta
180mm
PH-46.1803



Luer
170mm
reto
PH-46.1701
curvo
PH-46.1702

Goivas Ósseas Dupla Ação



Bohler
corte/mandíbula 3mm
150mm



Ruskin
184mm

Sicard
225mm
PH-46.2250





Pinça goiva angular Indian
corte/mandíbula 4mm
180mm

PH-46.1510

Goivas Ósseas Dupla Ação



reta

PH-46.1850



curva

PH-46.1851

Ruskin-Liston
185mm



curva

PH-46.2329

Stille-Ruskin
229mm



0^{1/1}

Largura da
mandíbula
mordedura
3mm

PH-46.3683

Dale
280mm

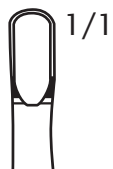

1/1

3mm

PH-46.2330

6mm

PH-46.2340

8mm

PH-46.2380

Leksell
229mm

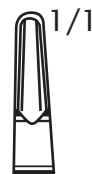

1/1

PH-46.2293

Frykholm
229mm

Goivas Ósseas Dupla Ação



Marquardt
203mm
curva
PH-46.2096



Fulton
242mm



reta
PH-46.2407



curva acentuada
PH-46.2409



levemente curva
PH-46.2408



Smith-Petersen
240mm



3mm
PH-46.2403



4mm
PH-46.2404



5mm
PH-46.2405



3mm
PH-46.2430



4mm
PH-46.2440



5mm
PH-46.2450



Beyer
178mm



3mm
PH-46.1783

Goivas Ósseas Simples Ação e Dupla Ação



1/1
Adson
200mm
PH-46.2025



1/1
4mm
Zaufal-Jansen
180mm
curva
PH-46.1740

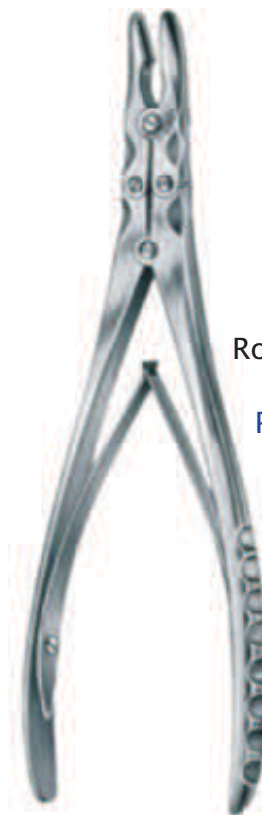

Rottgen-Ruskin
240mm
PH-46.2400



Mayfield
170mm
PH-46.1735



Kleinert-Kutz
150mm

1/1
2mm
PH-46.1520



1/1
3mm
PH-46.1530

abertura regulável
0,0 à 13,5cm

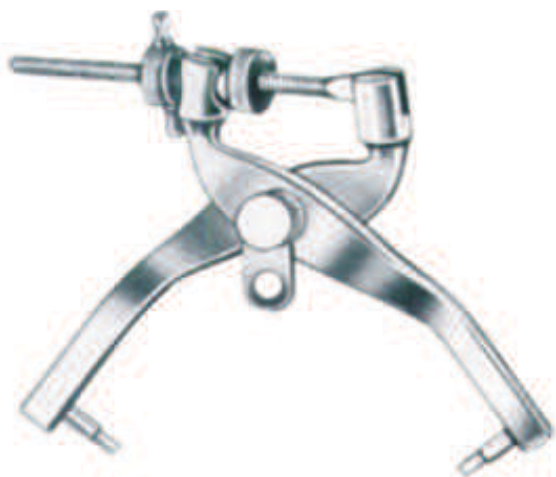

Trator Crutchfield
pequeno (infantil)
abertura máxima
210mm
PH-48.6270

abertura regulável
15,0cm



Trator Crutchfield
médio (adulto)
abertura máxima
240mm
PH-48.6273

Pontas para Crutchfield

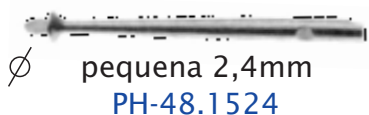

pequena 2,4mm
PH-48.1524



grande 3mm
PH-48.1530



Trator Gardner-Wells
abertura máxima 159mm
com porcas de ajustes e
gancho para tração cervical
PH-48.1590

Martelos Cirúrgicos

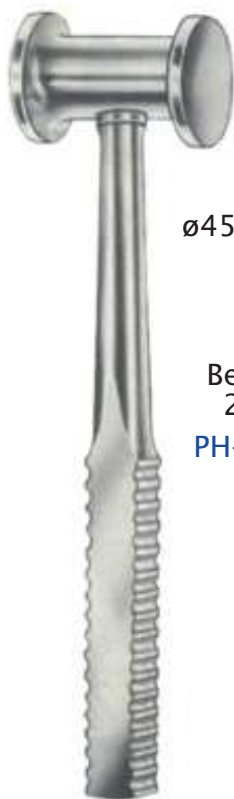

ø45mm

Bergmann
240mm
PH-49.2445

ø30mm

ø42mm



Bergmann
240mm
30mmx42mm
PH-49.2430



Ø22mm
Parsch
180mm
PH-49.1822



Lucae
190mm
Ø19mm
PH-49.1919
Ø25mm
PH-49.1925

Martelos Cirúrgicos

Martelo peso leve
com lado em aço e outro
revestido em nylon



255mm
450g
PH-49.2554
900g
PH-49.2559



ø25mm
18,0cm
PH-49.1814



320g
Ø26mm

Mead
170mm
PH-49.1726



140g
Ø27mm

Hajek
215mm
PH-49.2127



220g
Ø30mm

Collin
200mm
PH-49.2030



Ø50mm

Martelo Poliacetal
200mm
PH-49.2020



Conjunto para Osteotomia
PH-07.4533

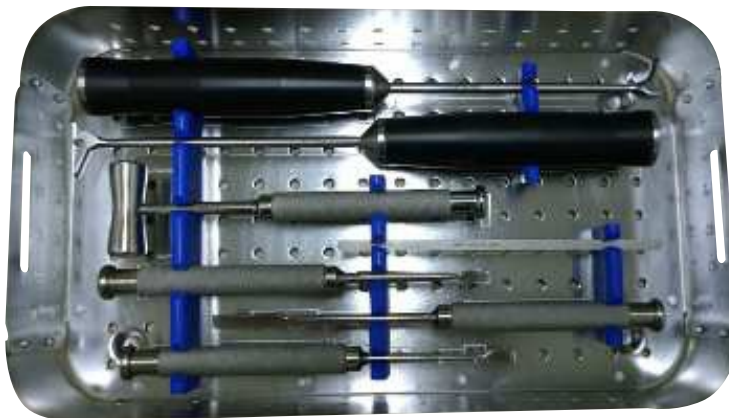

Impactor de muro posterior
3CO delicado
PH-07.4528

Impactor de muro
posterior 3CO
PH-07.4529

Cinzel de Cloward para
osteotomia 6,0mm
PH-46.2406

Espátula para
osteotomia 6,0mm
PH-07.4531

Martelo para osteotomia
PH-07.4530

Cinzel de Cloward para
osteotomia 8,0mm
PH-46.2480

Impactor Gutter lateral
PH-07.4532

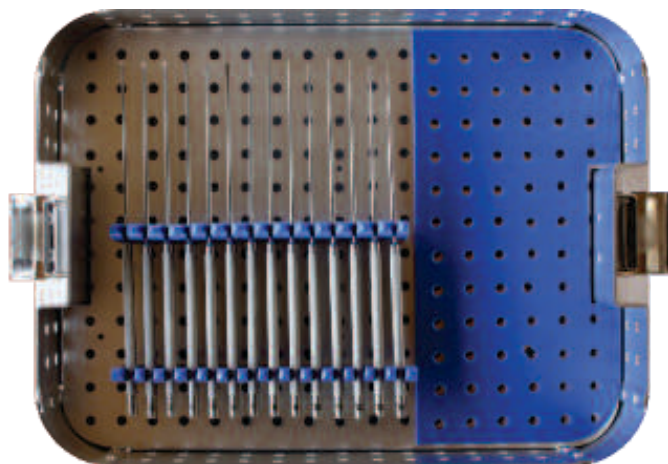

Instrumentos micro cirúrgicos Rhoton-Yasargil
estojo completo contendo 19 microdissectores

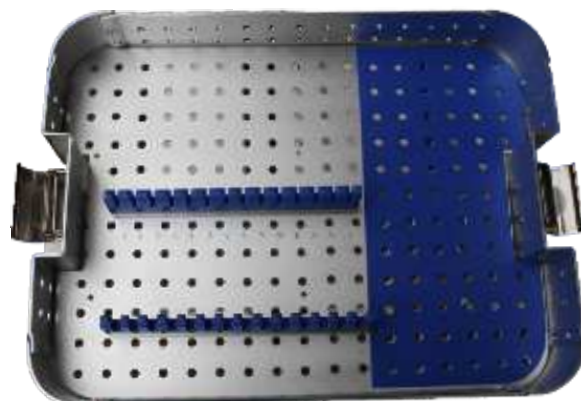

Estojo para microdissectores
PH-50.1817

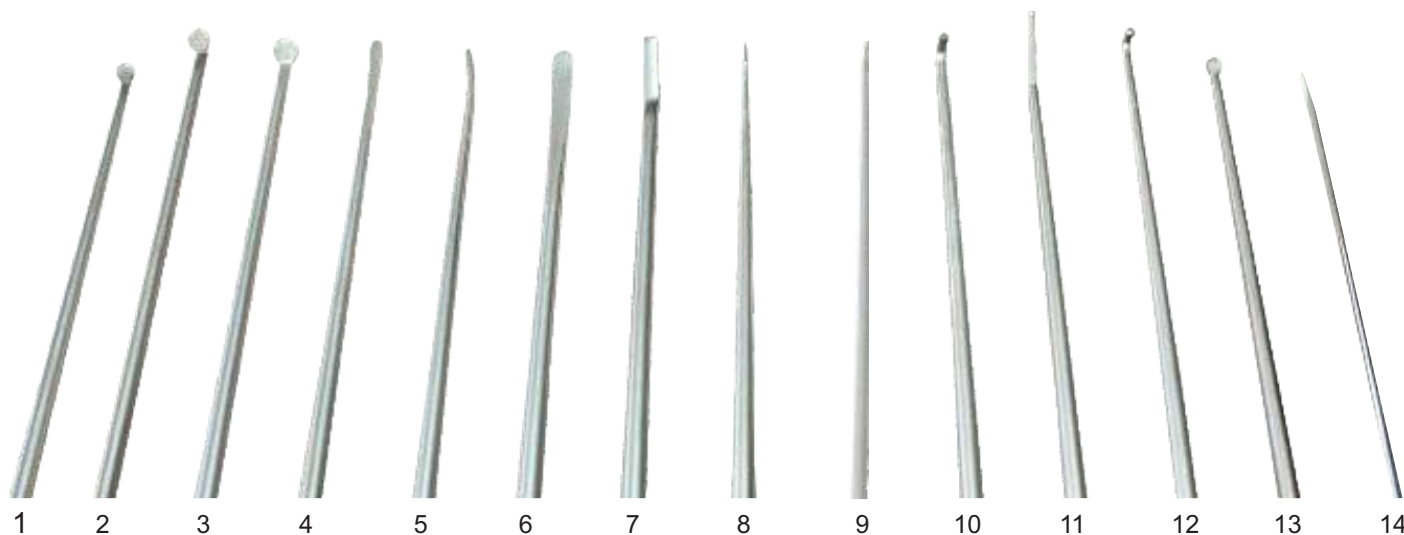

PH-50.1801 Micro raspador cortante lâmina redonda pequeno 2mm

PH-50.1802 Micro raspador cortante lâmina redonda médio 2,5mm

PH-50.1803 Micro raspador cortante lâmina redonda grande 3mm

PH-50.1804 Micro espátula pequena 1,5mm

PH-50.1805 Micro espátula média 2,0mm

PH-50.1806 Micro espátula grande 2,5mm

PH-50.1807 Micro espátula angulada cortante

PH-50.1808 Micro gancho afiado/agudo 90°

PH-50.1809 Micro gancho cego/rombo Angulado 40°

PH-50.1810 Micro dissector angulado 90° rombo

PH-50.1811 Micro dissector angulado 40° com bolinha

PH-50.1812 Micro dissector angulado 90° com bolinha

PH-50.1813 Micro cureta reta Ø 2.0mm

PH-50.1814 Micro bisturi reto
Faquinha para arachnóide

PH-50.1815 Micro dissector modelo gota reto

PH-22.2905 Micro Dissector modelo gota angulado 40° 8mm

PH-22.2901 Micro Dissector modelo gota angulado 90° 3mm

PH-42.2836 Micro dissector modelo gota angulado 40° 4mm

PH-42.2835 Micro dissector modelo gota angulado 90° 5mm

Micro Dissectores Yasargil

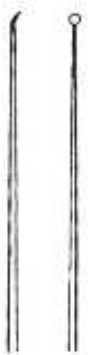

PH-50.1801



PH-50.1802



PH-50.1803



PH-50.1804



PH-50.1805



PH-50.1806



PH-50.1807



PH-50.1808



PH-50.1809



PH-50.1810



PH-50.1811



PH-50.1812



PH-50.1813



PH-50.1814



PH-50.1815

(opcional, não incluso no kit de Rhoton)



200mm

1/4



PH-42.2836



PH-22.2901



PH-22.2905



PH-42.2835

Micro Porta/Porta Agulha com Wídia

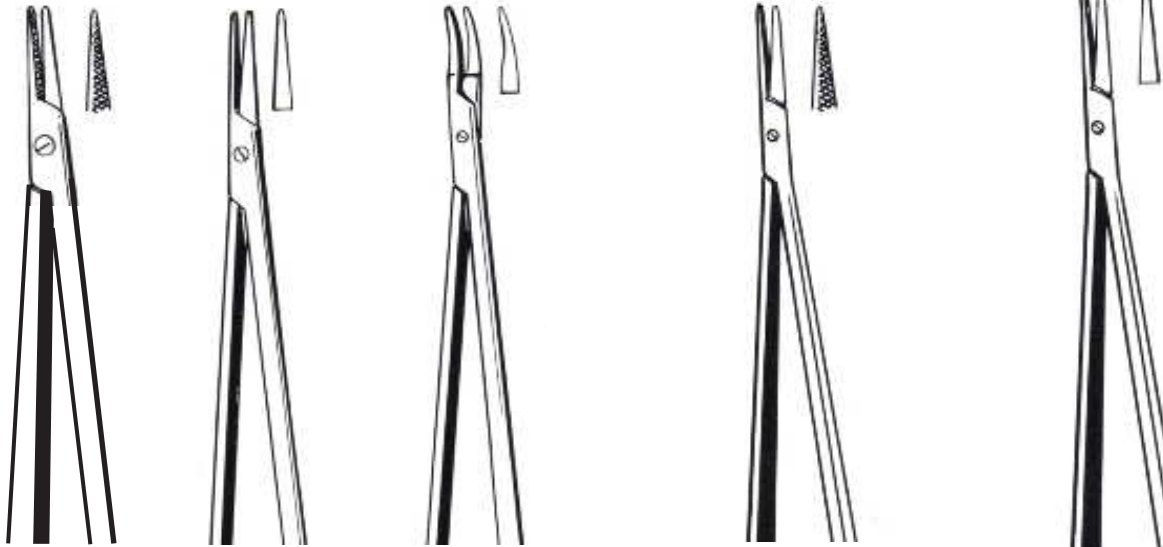

Porta agulha
com ponta de micro e wídia



P/ suturas delicadas
de duramater/crânio

160mm
PH-51.1601

P/ suturas delicadas de
duramater/medula cervical

180mm
PH-51.1804

P/ suturas delicadas de
duramater/lombar

200mm
PH-51.2000

reto com wídia
185mm

PH-51.1801

reto sem wídia
185mm

PH-51.1802

curvo sem wídia
185mm

PH-51.1803

reto com wídia
229mm

PH-51.2291

reto sem wídia
229mm

PH-51.2004

curvo sem wídia
229mm

PH-51.2293

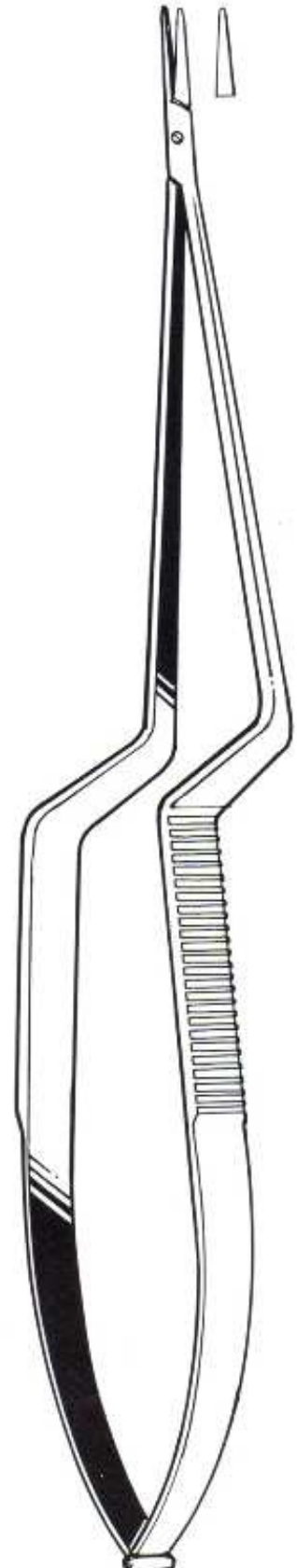

Jacobson em baioneta

Micro Tesouras em Baioneta



Mallis
em baioneta curta
180mm

Lâmina reta
PH-52.1801

Lâmina suavemente curva
PH-52.1802



Mallis
em baioneta média
200mm

Lâmina reta
PH-52.2001

Lâmina suavemente curva
PH-52.2002



Mallis
em baioneta longa
220mm

Lâmina reta
PH-52.2201

Lâmina suavemente curva
PH-52.2202



Mallis
em baioneta extra-longa
240mm

Lâmina reta
PH-52.2401

Lâmina suavemente curva
PH-52.2402

Micro Tesouras em Baioneta



Yasargil
165mm

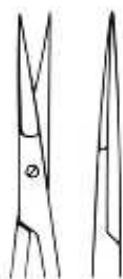

reta
165mm
PH-52.1603

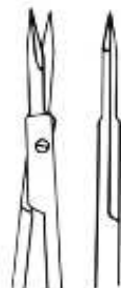

micro ponta
reta 165mm
PH-52.1605

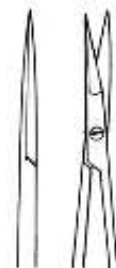

ponta reta fina
165mm
PH-52.1606

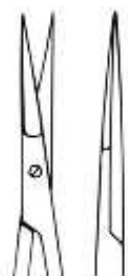

ponta reta
165mm
PH-52.1607



ponta curva
165mm
PH-52.1608

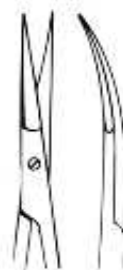

ponta curva
fina 165mm
PH-52.1609



ponta curva
extra-fina
165mm
PH-52.1610

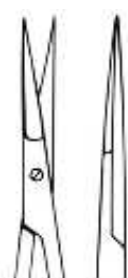

ponta reta
extra-fina
165mm
PH-52.1611

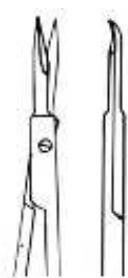

micro ponta
curva
165mm
PH-52.1612



ponta curva
arredondada
165mm
PH-52.1613

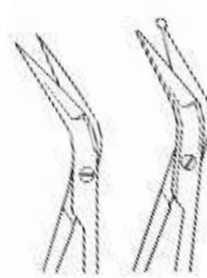

angulada 45°
165mm
sem proteção
PH-52.1614
com proteção
PH-52.1615

Micro Tesouras em Baioneta



1/1

Yasargil
180mm

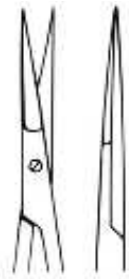

reta
180mm
PH-52.0118



micro ponta
reta 180mm
PH-52.1803

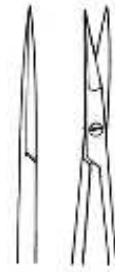

ponta reta fina
180mm
PH-52.1804

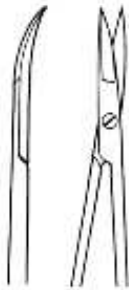

curva
180mm
PH-52.0218



ponta curva
fina
180mm
PH-52.1807



ponta curva
extra-fina
180mm
PH-52.1808



ponta reta
extra-fina
180mm
PH-52.1809

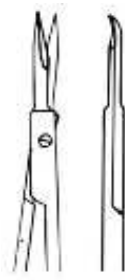

micro ponta
curva
180mm
PH-52.1810



ponta curva
arredondada
180mm
PH-52.1811

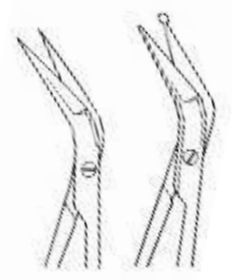

angulada 45°
180mm
sem proteção
PH-52.1812
com proteção
PH-52.1813



Yasargil
200mm

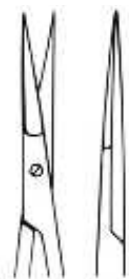

reta
200mm
PH-52.2005



micro ponta reta
200mm
PH-52.2003

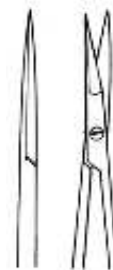

ponta reta fina
200mm
PH-52.2004

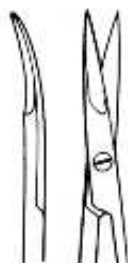

ponta curva
200mm
PH-52.2006

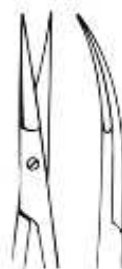

ponta curva fina
200mm
PH-52.2007



ponta curva extra fina
200mm
PH-52.2008

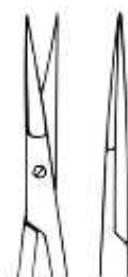

ponta reta
extra-fina
200mm
PH-52.2009

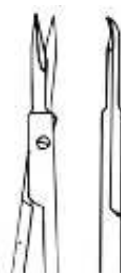

micro ponta
curva
200mm
PH-52.2010



ponta curva
arredondada
200mm
PH-52.2011

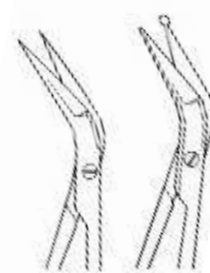

angulada 45°
200mm
sem proteção
PH-52.2012
com proteção
PH-52.2013



1/1
Yasargil
225mm

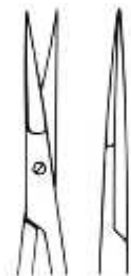

ponta reta
225mm
PH-52.2205

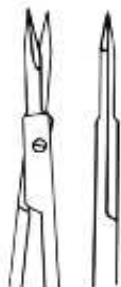

micro ponta reta
225mm
PH-52.2203

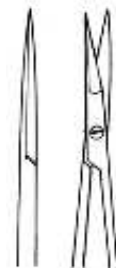

ponta reta fina
225mm
PH-52.2204

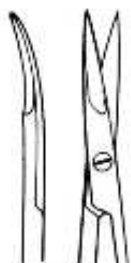

ponta curva
225mm
PH-52.2206

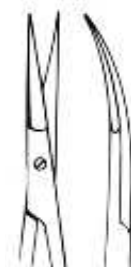

ponta curva fina
225mm
PH-52.2207



ponta curva extra fina
225mm
PH-52.2208

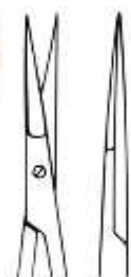

ponta reta
extra-fina
225mm
PH-52.2209

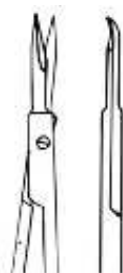

micro ponta
curva
225mm
PH-52.2210



ponta curva
arredondada
225mm
PH-52.2211

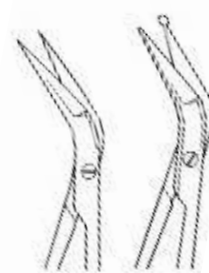

angulada 45°
sem proteção
225mm
PH-52.2212
com proteção
225mm
PH-52.2213

Micro Tesouras em Baioneta / Reta



Jacobson
190mm



curva
PH-52.1901



angulada
PH-52.1902



reta
PH-52.1903



micro ponta reta
PH-52.1904



micro ponta angulada
PH-52.1905



Jacobson
180mm



curva
PH-52.1819



angulada
PH-52.1820



reta
PH-52.1821

Micro Tesoura Retas



Potts-Smith
reta
185mm
PH-52.1851



Potts-Smith
curva
185mm
PH-52.1852



Potts-Smith
angulada
185mm
PH-52.1853



Potts-Smith
230mm
PH-52.2300

Micro Tesouras em Baioneta / Reta

Vannas
160mm



reta
PH-52.1616



curva
PH-52.1617



Vannas
160mm



micro ponta
reta
PH-52.1618



micro ponta
curva
PH-52.1619

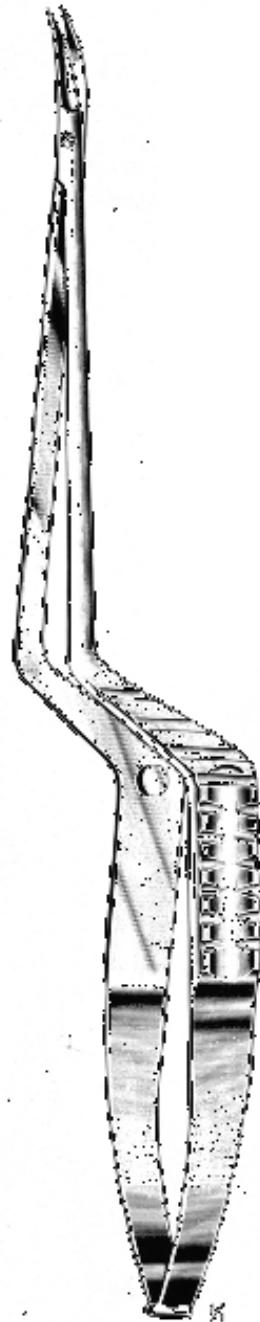

Vannas



reta
160mm
PH-52.1620



curva
160mm
PH-52.1621



Reta
180mm
PH-52.0018



curva
180mm
PH-52.0019

Micro Tesouras Retas Neuro Cirúrgicas Vasculares



Micro tesoura vascular
60° degree

180mm
PH-59.0018

200mm
PH-59.0020

230mm
PH-59.0023



Micro tesoura vascular
cava direita 130° lateral

160mm
PH-59.0016

185mm
PH-59.0185

200mm
PH-59.0120



Pinça para Tumores



Yasargil
220mm



3mm
PH-53.2207



5mm
PH-53.2208



serrilha
3mm
PH-53.2209

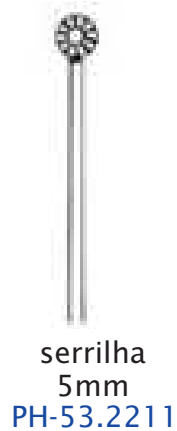

serrilha
5mm
PH-53.2211



dente
3mm
PH-53.2212



dente
5mm
PH-53.2213



Yasargil
200mm



0.6mm
PH-54.0600

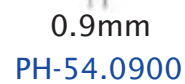

0.9mm
PH-54.0900



1x2 dentes micro
PH-54.1800

Pinça para Tumores



3mm
PH-53.2201

5mm
PH-53.2202

7mm
PH-53.2200

serrilha
3mm
PH-53.2203

serrilha
7mm
PH-53.2214

dente
3mm
PH-53.2204

dente
5mm
PH-53.2205

dente
7mm
PH-53.2206

Hunt-Yasargil
220mm



angulada para cima/esquerdo

Ø3mm PH-54.2303 Ø4mm PH-54.2304 Ø5mm PH-54.2305

angulada para baixo/direita

Ø3mm PH-54.2330 Ø4mm PH-54.2340 Ø5mm PH-54.2350

Yasargil Samii
230mm

Pinças Micro-Cirúrgicas Delicadas

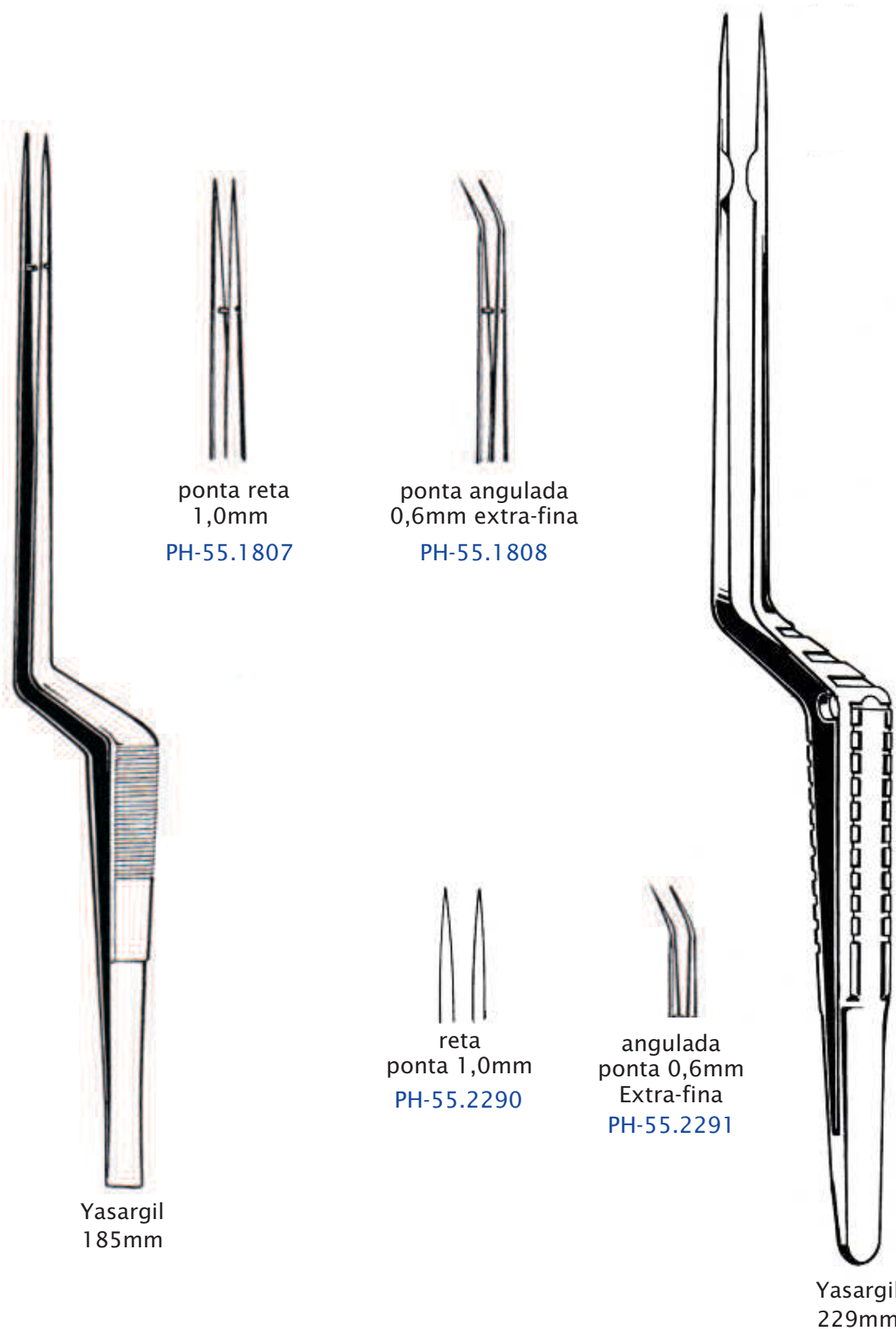



Lazar reta
ponta 0,2mm
110mm
PH-55.1102



Lazar reta
ponta 0,15mm
110mm
PH-55.1105



Lazar curva
ponta 0,2mm
115mm
PH-55.1152



Lazar reta
ponta 0,3mm
125mm
PH-55.1253



Lazar
ponta 0,5mm
155mm
PH-55.1555



Lazar
ponta 0,8mm
155mm
PH-55.1558



Lazar
ponta 0,5mm
185mm
PH-55.1855



Lazar
ponta 0,8mm
185mm
PH-55.1858

Pinças Micro-Cirúrgicas Delicadas



Micro-Adson
serrilhada
120mm
PH-55.1201



Adson
serrilhada
120mm
PH-55.1202



Adson Brown
9x9 micro dentes
120mm
PH-55.1255



Semken
125mm
PH-55.1254

150mm
PH-55.1550

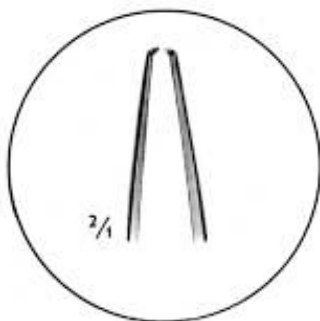

1x2 dentes micro
120mm
PH-55.1212

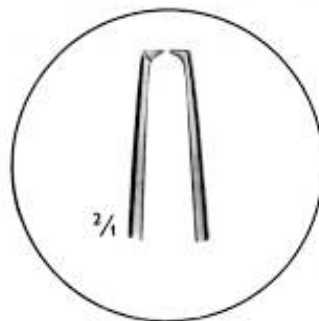

1x2 dentes micro
150mm
PH-55.1501

1x2 dentes
120mm
PH-55.1213

1x2 dentes
150mm
PH-55.1502

1x2 dentes com widia
120mm
PH-55.1214

1x2 dentes com widia
150mm
PH-55.1503



Adson



Semken
1x2 Dentes
125mm
PH-55.1256

1x2 dentes
150mm
PH-55.1551



Semken
2x3 dentes
125mm
PH-55.1223

Pinças Micro-Cirúrgicas Delicadas



Gerald reta
serrilhada
180mm
PH-55.1801



Gerald curva
serrilhada
180mm
PH-55.1802



Gerald reta
1x2 dentes
180mm
PH-55.1804



Gerald curva
1x2 dentes
180mm
PH-55.1805
200mm
PH-55.1811



Taylor curva
1x2 dentes
175mm
PH-55.1750



Potts-Smith
serrilhada
180mm
PH-55.1803



Potts-Smith
1x2 dentes
180mm
PH-55.1806
200mm
PH-55.1820



Cushing reto
1x2 dentes
180mm
PH-55.1809



Cushing curva
1x2 dentes
180mm
PH-55.1810



Jansen Gruenwald
serrilhada
210mm
PH-55.2110
1x2 dentes
PH-55.2111



Lucae serrilhada
140mm
PH-55.1401
180mm
PH-55.1800
210mm
PH-55.2100

Pinças para Tumores

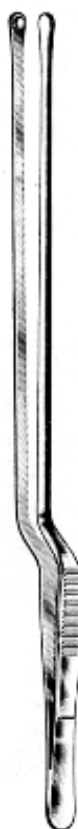

Pinça Adson
215mm
PH-53.2150



Pinça Adson
230mm
PH-53.2301



Pinça Wilde
angulada
140mm
PH-37.1401
180mm
PH-37.1802



Pinça Jansen
baioneta
160mm
PH-37.1616
180mm
PH-37.1818
200mm
PH-37.2020

Pinças para Hérnia de disco Pinças para Remoção de Tecido Mole

Roedores para disco intervertebral



4x8mm



6x10mm



6x12mm

Pinça Love Ferris-Smith
180mm

4,0mmx8,0mm

PH-56.4080

6,0mmx10mm

PH-56.6010

6,0mmx12mm

PH-56.6012



ø6mm

Pinça Oldberg

178mm

PH-56.1780



Roedores para disco intervertebral

Pinça Wilde intervertebral reta
140mm

5,0mm

PH-56.5015

5,5mm

PH-56.5515

6,0mm

PH-56.6015



Pinça Hoen intervertebral
reta fenestrada
140mm

4,0mmx12mm

PH-56.4012

Pinças para Hérnia de disco / Pinças para Remoção de Tecido Mole

Roedores para disco intervertebral

comprimento eixo/haste

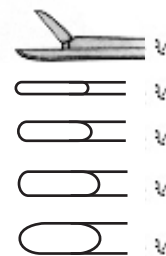

Nome	Medida
Delicate	1x10mm
Cushing	2x10mm
Gruenwald	3x10mm
Spurling	4x10mm
Schlesinger	5x10mm
Cloward	6x10mm



Pinça Love



Largura da boca mandíbula

eixo/haste 140mm

Largura da boca mandíbula

eixo/haste 140mm



1,0mm PH-56.1431
2,0mm PH-56.1401
3,0mm PH-56.1402
4,0mm PH-56.1403
5,0mm PH-56.1404
6,0mm PH-56.1405



1,0mm PH-56.1434
2,0mm PH-56.1416
3,0mm PH-56.1417
4,0mm PH-56.1418
5,0mm PH-56.1419
6,0mm PH-56.1420



1,0mm PH-56.1432
2,0mm PH-56.1406
3,0mm PH-56.1407
4,0mm PH-56.1408
5,0mm PH-56.1409
6,0mm PH-56.1410



1,0mm PH-56.1435
2,0mm PH-56.1421
3,0mm PH-56.1422
4,0mm PH-56.1423
5,0mm PH-56.1424
6,0mm PH-56.1425



1,0mm PH-56.1433
2,0mm PH-56.1411
3,0mm PH-56.1412
4,0mm PH-56.1413
5,0mm PH-56.1414
6,0mm PH-56.1415



1,0mm PH-56.1436
2,0mm PH-56.1426
3,0mm PH-56.1427
4,0mm PH-56.1428
5,0mm PH-56.1429
6,0mm PH-56.1430

Roedores para disco intervertebral

comprimento eixo/haste

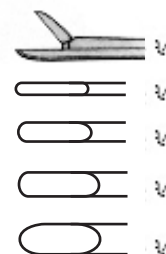

Nome	Medida
Delicate	1x10mm
Cushing	2x10mm
Gruenwald	3x10mm
Spurling	4x10mm
Schlesinger	5x10mm
Cloward	6x10mm



Pinça Love



Largura da boca mandíbula eixo/haste 155mm

Largura da boca mandíbula eixo/haste 155mm



- 1,0mm PH-44.1581
- 2,0mm PH-44.1551
- 3,0mm PH-44.1552
- 4,0mm PH-44.1553
- 5,0mm PH-44.1554
- 6,0mm PH-44.1555



- 1,0mm PH-44.1584
- 2,0mm PH-44.1566
- 3,0mm PH-44.1567
- 4,0mm PH-44.1568
- 5,0mm PH-44.1569
- 6,0mm PH-44.1570



- 1,0mm PH-44.1582
- 2,0mm PH-44.1556
- 3,0mm PH-44.1557
- 4,0mm PH-44.1558
- 5,0mm PH-44.1559
- 6,0mm PH-44.1560



- 1,0mm PH-44.1585
- 2,0mm PH-44.1571
- 3,0mm PH-44.1572
- 4,0mm PH-44.1573
- 5,0mm PH-44.1574
- 6,0mm PH-44.1575



- 1,0mm PH-44.1583
- 2,0mm PH-44.1561
- 3,0mm PH-44.1562
- 4,0mm PH-44.1563
- 5,0mm PH-44.1564
- 6,0mm PH-44.1565



- 1,0mm PH-44.1586
- 2,0mm PH-44.1576
- 3,0mm PH-44.1577
- 4,0mm PH-44.1578
- 5,0mm PH-44.1579
- 6,0mm PH-44.1580

Pinças para Hérnia de disco / Pinças para Remoção de Tecido Mole

Roedores para disco intervertebral

comprimento eixo/haste

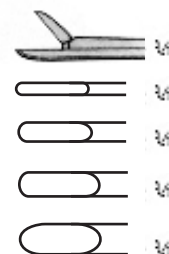

Nome	Medida
Delicate	1x10mm
Cushing	2x10mm
Gruenwald	3x10mm
Spurling	4x10mm
Schlesinger	5x10mm
Cloward	6x10mm



Pinça Love



Largura da boca mandíbula eixo/haste 178mm



Largura da boca mandíbula eixo/haste 178mm



1,0mm PH-56.1731
2,0mm PH-56.1701
3,0mm PH-56.1702
4,0mm PH-56.1703
5,0mm PH-56.1704
6,0mm PH-56.1705



1,0mm PH-56.1734
2,0mm PH-56.1716
3,0mm PH-56.1717
4,0mm PH-56.1718
5,0mm PH-56.1719
6,0mm PH-56.1720



1,0mm PH-56.1732
2,0mm PH-56.1706
3,0mm PH-56.1707
4,0mm PH-56.1708
5,0mm PH-56.1709
6,0mm PH-56.1710



1,0mm PH-56.1735
2,0mm PH-56.1721
3,0mm PH-56.1722
4,0mm PH-56.1723
5,0mm PH-56.1724
6,0mm PH-56.1725



1,0mm PH-56.1733
2,0mm PH-56.1711
3,0mm PH-56.1712
4,0mm PH-56.1713
5,0mm PH-56.1714
6,0mm PH-56.1715



1,0mm PH-56.1736
2,0mm PH-56.1726
3,0mm PH-56.1727
4,0mm PH-56.1728
5,0mm PH-56.1729
6,0mm PH-56.1730

Roedores para disco intervertebral

comprimento eixo/haste

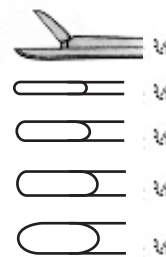

Nome	Medida
Delicate	1x10mm
Cushing	2x10mm
Gruenwald	3x10mm
Spurling	4x10mm
Schlesinger	5x10mm
Cloward	6x10mm



Pinça Love



Largura da boca mandíbula eixo/haste 203mm



Largura da boca mandíbula eixo/haste 203mm



- 1,0mm PH-56.2061
- 2,0mm PH-56.2031
- 3,0mm PH-56.2032
- 4,0mm PH-56.2033
- 5,0mm PH-56.2034
- 6,0mm PH-56.2035



- 1,0mm PH-56.2064
- 2,0mm PH-56.2046
- 3,0mm PH-56.2047
- 4,0mm PH-56.2048
- 5,0mm PH-56.2049
- 6,0mm PH-56.2050



- 1,0mm PH-56.2062
- 2,0mm PH-56.2036
- 3,0mm PH-56.2037
- 4,0mm PH-56.2038
- 5,0mm PH-56.2039
- 6,0mm PH-56.2040



- 1,0mm PH-56.2065
- 2,0mm PH-56.2051
- 3,0mm PH-56.2052
- 4,0mm PH-56.2053
- 5,0mm PH-56.2054
- 6,0mm PH-56.2055



- 1,0mm PH-56.2063
- 2,0mm PH-56.2041
- 3,0mm PH-56.2042
- 4,0mm PH-56.2043
- 5,0mm PH-56.2044
- 6,0mm PH-56.2045



- 1,0mm PH-56.2066
- 2,0mm PH-56.2056
- 3,0mm PH-56.2057
- 4,0mm PH-56.2058
- 5,0mm PH-56.2059
- 6,0mm PH-56.2060

Pinças para Hérnia de disco / Pinças para Remoção de Tecido Mole

Roedores para disco intervertebral

comprimento
eixo/haste

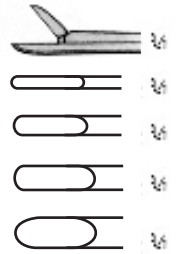

Nome	Medida
Delicate	1x10mm
Cushing	2x10mm
Gruenwald	3x10mm
Spurling	4x10mm
Schlesinger	5x10mm
Cloward	6x10mm



Pinça Love



mandíbula 229mm



- 1,0mm PH-56.2295
- 2,0mm PH-56.1801
- 3,0mm PH-56.1802
- 4,0mm PH-56.1803
- 5,0mm PH-56.1804
- 6,0mm PH-56.1805



mandíbula 229mm



- 1,0mm PH-56.2298
- 2,0mm PH-56.2280
- 3,0mm PH-56.2281
- 4,0mm PH-56.2282
- 5,0mm PH-56.2283
- 6,0mm PH-56.2284



- 1,0mm PH-56.2296
- 2,0mm PH-56.1806
- 3,0mm PH-56.1807
- 4,0mm PH-56.1808
- 5,0mm PH-56.1809
- 6,0mm PH-56.1810



- 1,0mm PH-56.2299
- 2,0mm PH-56.2285
- 3,0mm PH-56.2286
- 4,0mm PH-56.2287
- 5,0mm PH-56.2288
- 6,0mm PH-56.2289



- 1,0mm PH-56.2297
- 2,0mm PH-56.1811
- 3,0mm PH-56.1812
- 4,0mm PH-56.1813
- 5,0mm PH-56.1814
- 6,0mm PH-56.1815



- 1,0mm PH-56.2300
- 2,0mm PH-56.2290
- 3,0mm PH-56.2291
- 4,0mm PH-56.2292
- 5,0mm PH-56.2293
- 6,0mm PH-56.2294

Pinças para Hérnia de disco / Pinças para Remoção de Tecido Mole

Roedores para disco intervertebral tamanhos especiais

comprimento
eixo/haste

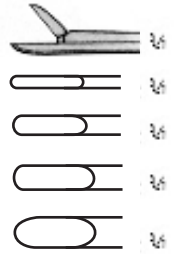

Nome	Medida
Delicate	1x10mm
Cushing	2x10mm
Gruenwald	3x10mm
Spurling	4x10mm
Schlesinger	5x10mm
Cloward	6x10mm



Largura da boca
mandíbula eixo/haste
279mm

Largura da boca
mandíbula eixo/haste
279mm



2,0mm PH-56.2785
3,0mm PH-56.2786
4,0mm PH-56.2787
5,0mm PH-56.2788
6,0mm PH-56.2789



2,0mm PH-56.2710
3,0mm PH-56.2711
4,0mm PH-56.2712
5,0mm PH-56.2713
6,0mm PH-56.2714



2,0mm PH-56.2790
3,0mm PH-56.2791
4,0mm PH-56.2792
5,0mm PH-56.2793
6,0mm PH-56.2794



2,0mm PH-56.2715
3,0mm PH-56.2716
4,0mm PH-56.2717
5,0mm PH-56.2718
6,0mm PH-56.2719



2,0mm PH-56.2795
3,0mm PH-56.2796
4,0mm PH-56.2797
5,0mm PH-56.2798
6,0mm PH-56.2799



2,0mm PH-56.2720
3,0mm PH-56.2721
4,0mm PH-56.2722
5,0mm PH-56.2723
6,0mm PH-56.2724

Pinças para Hérnia de disco / Pinças para Remoção de Tecido Mole

Roedores para disco intervertebral
tamanhos especiais

comprimento
eixo/haste

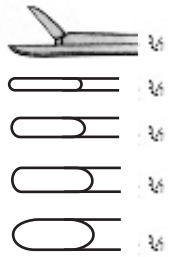

Nome	Medida
Delicate	1x10mm
Cushing	2x10mm
Gruenwald	3x10mm
Spurling	4x10mm
Schlesinger	5x10mm
Cloward	6x10mm



Pinça Love



Largura da boca mandíbula	eixo/haste
2,0mm	305mm
3,0mm	PH-56.3050
4,0mm	PH-56.3051
5,0mm	PH-56.3052
6,0mm	PH-56.3053
6,0mm	PH-56.3054



Largura da boca mandíbula	eixo/haste
2,0mm	305mm
3,0mm	PH-56.3010
4,0mm	PH-56.3011
5,0mm	PH-56.3012
6,0mm	PH-56.3013
6,0mm	PH-56.3014



Largura da boca mandíbula	eixo/haste
2,0mm	PH-56.3055
3,0mm	PH-56.3056
4,0mm	PH-56.3057
5,0mm	PH-56.3058
6,0mm	PH-56.3059



Largura da boca mandíbula	eixo/haste
2,0mm	PH-56.3015
3,0mm	PH-56.3016
4,0mm	PH-56.3017
5,0mm	PH-56.3018
6,0mm	PH-56.3019



Largura da boca mandíbula	eixo/haste
2,0mm	PH-56.3060
3,0mm	PH-56.3061
4,0mm	PH-56.3062
5,0mm	PH-56.3063
6,0mm	PH-56.3064



Largura da boca mandíbula	eixo/haste
2,0mm	PH-56.3020
3,0mm	PH-56.3021
4,0mm	PH-56.3022
5,0mm	PH-56.3023
6,0mm	PH-56.3024



Passador de Cateter



Neonatal
315mm
PH-41.3150

Infantil
400mm
PH-41.3140

Adulto
60,0cm
PH-41.3160
65,0cm
PH-14.0617
70,0cm
PH-14.0618
80,0cm
PH-14.0446
90,0cm
PH-14.0447

Pinças para Laminectomia Pinça Kerrison

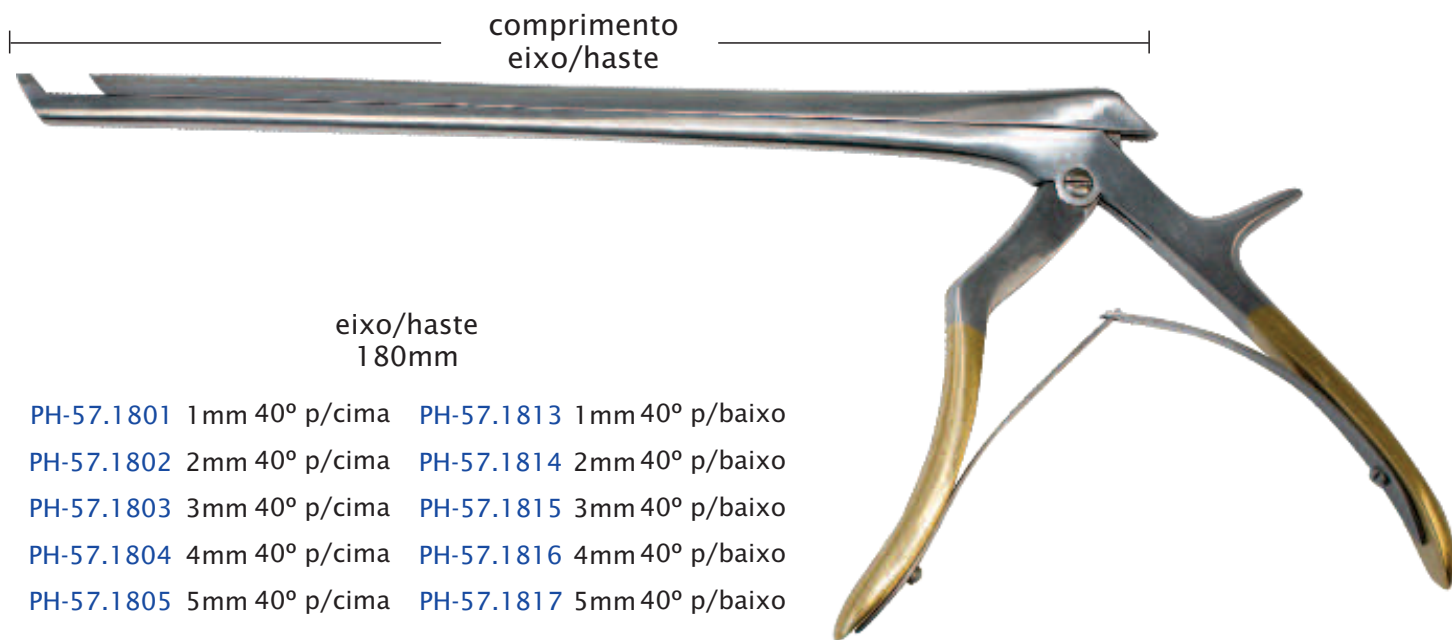

eixo/haste
180mm

- | | |
|---------------------------|----------------------------|
| PH-57.1801 1mm 40° p/cima | PH-57.1813 1mm 40° p/baixo |
| PH-57.1802 2mm 40° p/cima | PH-57.1814 2mm 40° p/baixo |
| PH-57.1803 3mm 40° p/cima | PH-57.1815 3mm 40° p/baixo |
| PH-57.1804 4mm 40° p/cima | PH-57.1816 4mm 40° p/baixo |
| PH-57.1805 5mm 40° p/cima | PH-57.1817 5mm 40° p/baixo |

- | | |
|---------------------------|----------------------------|
| PH-57.1807 1mm 90° p/cima | PH-57.1819 1mm 90° p/baixo |
| PH-57.1808 2mm 90° p/cima | PH-57.1820 2mm 90° p/baixo |
| PH-57.1809 3mm 90° p/cima | PH-57.1821 3mm 90° p/baixo |
| PH-57.1810 4mm 90° p/cima | PH-57.1822 4mm 90° p/baixo |
| PH-57.1811 5mm 90° p/cima | PH-57.1823 5mm 90° p/baixo |

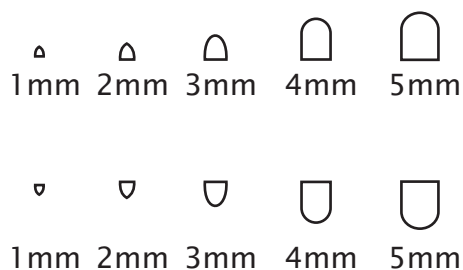

eixo/haste
203mm

- | | | | |
|---------------------------|----------------------------|---------------------------|----------------------------|
| PH-57.2001 1mm 40° p/cima | PH-57.2013 1mm 40° p/baixo | PH-57.2301 1mm 40° p/cima | PH-57.2313 1mm 40° p/baixo |
| PH-57.2002 2mm 40° p/cima | PH-57.2014 2mm 40° p/baixo | PH-57.2302 2mm 40° p/cima | PH-57.2314 2mm 40° p/baixo |
| PH-57.2003 3mm 40° p/cima | PH-57.2015 3mm 40° p/baixo | PH-57.2303 3mm 40° p/cima | PH-57.2315 3mm 40° p/baixo |
| PH-57.2004 4mm 40° p/cima | PH-57.2016 4mm 40° p/baixo | PH-57.2304 4mm 40° p/cima | PH-57.2316 4mm 40° p/baixo |
| PH-57.2005 5mm 40° p/cima | PH-57.2017 5mm 40° p/baixo | PH-57.2305 5mm 40° p/cima | PH-57.2317 5mm 40° p/baixo |
| PH-57.2006 6mm 40° p/cima | PH-57.2018 6mm 40° p/baixo | PH-57.2306 6mm 40° p/cima | PH-57.2318 6mm 40° p/baixo |
| PH-57.2007 1mm 90° p/cima | PH-57.2019 1mm 90° p/baixo | PH-57.2307 1mm 90° p/cima | PH-57.2319 1mm 90° p/baixo |
| PH-57.2008 2mm 90° p/cima | PH-57.2020 2mm 90° p/baixo | PH-57.2308 2mm 90° p/cima | PH-57.2320 2mm 90° p/baixo |
| PH-57.2009 3mm 90° p/cima | PH-57.2021 3mm 90° p/baixo | PH-57.2309 3mm 90° p/cima | PH-57.2321 3mm 90° p/baixo |
| PH-57.2010 4mm 90° p/cima | PH-57.2022 4mm 90° p/baixo | PH-57.2310 4mm 90° p/cima | PH-57.2322 4mm 90° p/baixo |
| PH-57.2011 5mm 90° p/cima | PH-57.2023 5mm 90° p/baixo | PH-57.2311 5mm 90° p/cima | PH-57.2323 5mm 90° p/baixo |

eixo/haste
230mm

Pinças para Laminectomia Pinça Kerrison

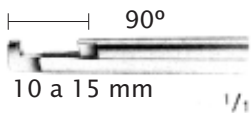

- 90° p/cima
- 1mm
- PH-57.1825
- 2mm
- PH-57.1826
- 3mm
- PH-57.1827
- 4mm
- PH-57.1828
- 5mm
- PH-57.1829

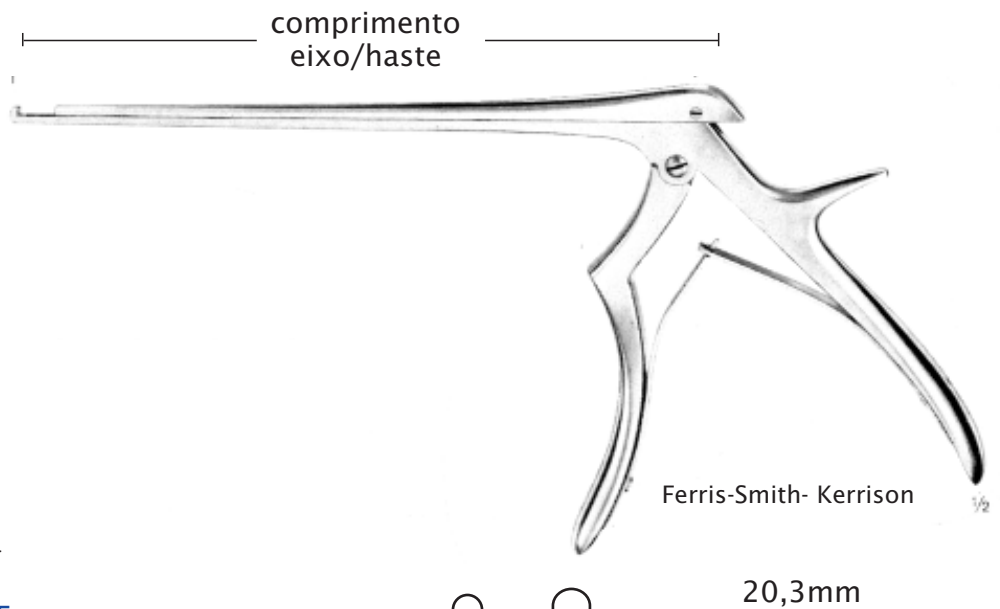
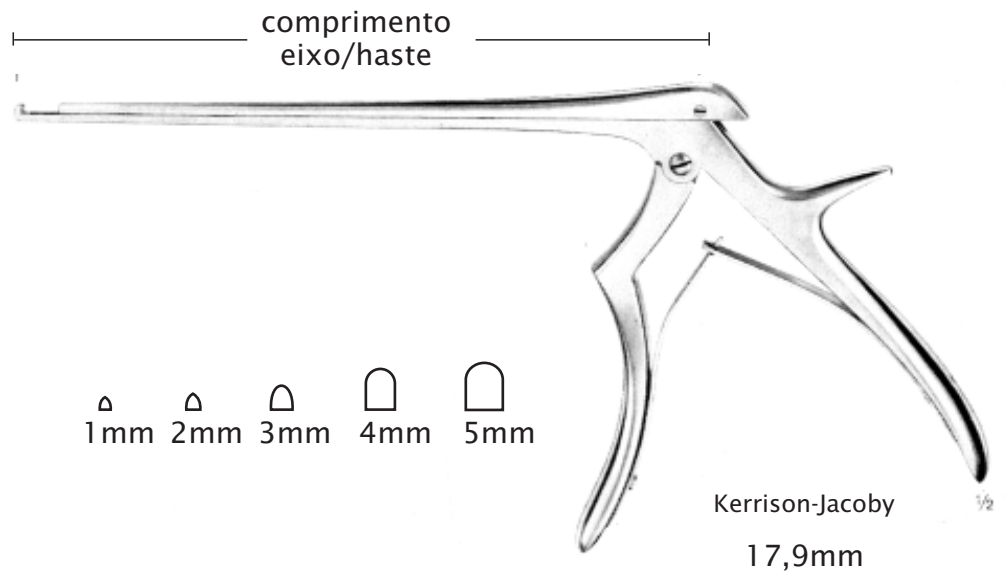

- | | |
|------------|------------|
| 40° p/cima | 90° p/cima |
| 1mm | 1mm |
| PH-57.1830 | PH-57.1835 |
| 2mm | 2mm |
| PH-57.1831 | PH-57.1836 |
| 3mm | 3mm |
| PH-57.1832 | PH-57.1837 |
| 4mm | 4mm |
| PH-57.1833 | PH-57.1838 |
| 5mm | 5mm |
| PH-57.1834 | PH-57.1839 |

- | | | | | |
|-----|-----|-----|-----|-----|
| 1mm | 2mm | 3mm | 4mm | 5mm |
| 1mm | 2mm | 3mm | 4mm | 5mm |

Tamanhos especiais

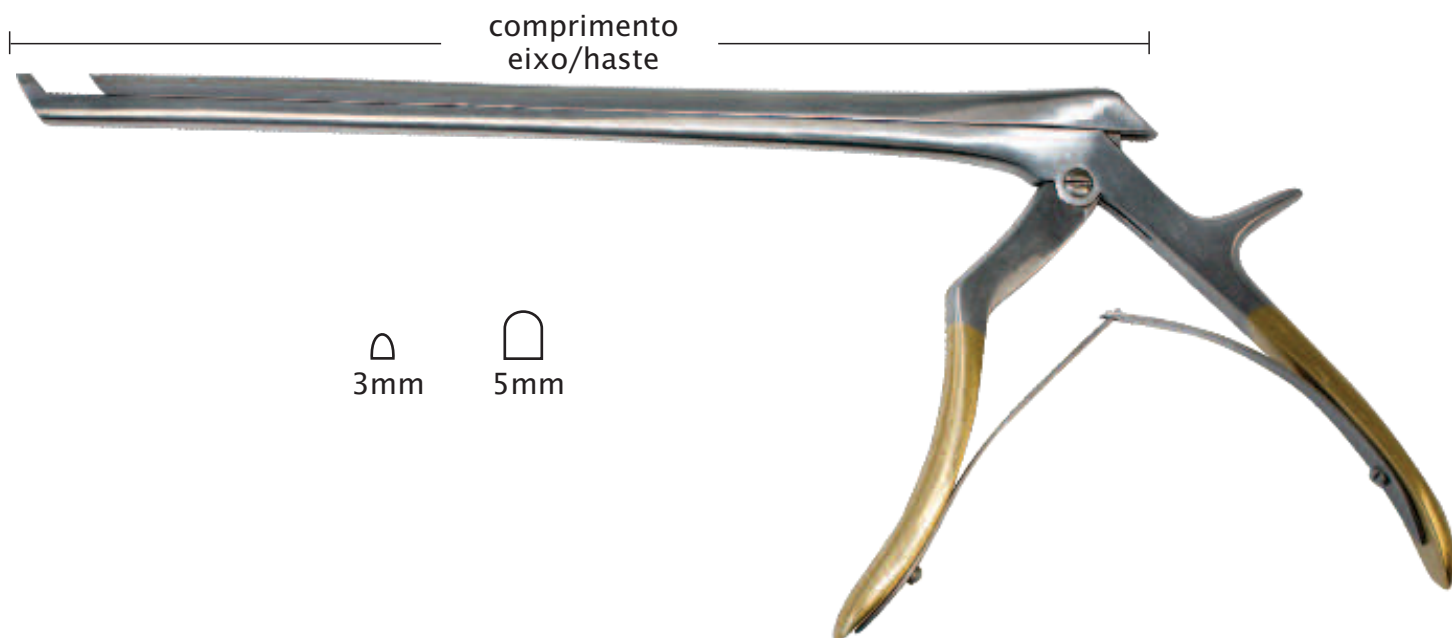

comprimento
eixo/haste

3mm

5mm

eixo/haste
279mm

PH-57.2703 3mm 40° p/cima

PH-57.2705 5mm 40° p/cima

eixo/haste
300mm

PH-57.3003 3mm 40° p/cima

PH-57.3005 5mm 40° p/cima

Pinça para Laminectomia Saca Bocados



2mm
PH-57.1840

3mm
PH-57.1841

4mm
PH-57.1842

5mm
PH-57.1843

Kerrison-Black
sistema de desmontagem para
facilitação de limpeza
180mm



1mm
PH-62.1821

2mm
PH-62.1822

3mm
PH-62.1823

4mm
PH-62.1824

5mm
PH-62.1825

Kerrison para cima 180mm

Tesouras Neuro Cirúrgicas



Tesoura Frazier
para duramater
170mm
PH-58.1710



Tesoura Strully
para duramater
203mm
PH-58.2030



Tesoura Taylor
para duramater
146mm
PH-58.1460

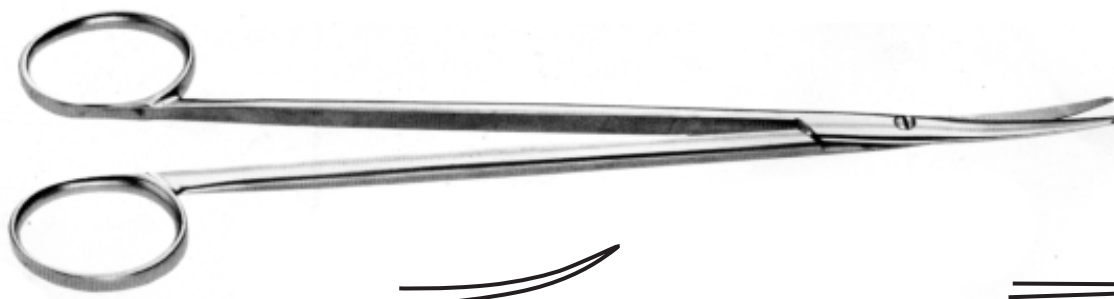

Tesoura
Metzenbaum

curva
200mm
PH-58.2000

curva
180mm
PH-58.1801

reta
200mm
PH-58.2001

reta
180mm
PH-58.1800

Rugina / Descolador de Periósteo Elevadores Duramater

PH-44.2110 10mm

PH-44.2115 15mm

PH-44.2120 20mm

PH-44.2125 25mm

PH-44.1945 5,0mm

PH-44.1918 17,0mm

PH-44.2066 6,0mm

PH-44.1835 3,5mm

PH-44.2003 3,5mm

PH-44.1740 4,0mm

PH-44.2305 5,0mm

PH-44.2067

PH-44.2150



Lambotte
210mm



Cushing
194mm



Langenbeck
191mm



Langenbeck estreito
206mm



Elevador Malis titânio reto
184mm



Elevador Malis titânio baioneta
203mm



Presbyterian
178mm



Cohen
230mm

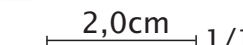

Elevador de duramater
tipo Fujita
200mm



Elevador de duramater
tipo Fujita
215mm

Trefina para Biópsia e Trocater



Trefina de biópsia óssea
com trocater
tipo cureta 165mm
Ø10,0mm

PH-61.1602

Ø8,0mm

PH-61.1601



Instrumental ideal para
coleta óssea de biópsia coluna.

PH-14.0619



Trocater com mandril
ponta aguda ø4mm
130mm

PH-61.1300

Cadeira para Neurocirurgia



Cadeira para
cirurgião
PH-80.0001





- Desenvolvido em modernos parâmetros para cirurgia de coluna
- Radiopaco em 360°, permitindo raio-X em AP/Perfil Oblíquo
- Ajustes laterais para liberar o abdômem, evitando compressões através da regulação manual.
- Compatível com RX/TC, arco cirúrgico.
- Preciso, de fácil manejo e transporte.

PHR-5000

Halo Vest



pequeno
PH-75.6650

médio
PH-75.6655

grande
PH-75.6660



espátula
PH-75.6665



chave
PH-75.6670

Indicado nos traumatismos e imobilização da coluna cervical e torácica. Ajustável ao tamanho do paciente e confeccionado em alumínio revestido em teflon, fecho velcro, polipropileno, titânio e forrado com pele de ovinho gerando mais segurança e conforto ao paciente.

Curetas Especiais / Via Lateral Cirurgia Tóraco Lombar Transforaminal



curva 35°
R. 30mm
ø 9,5 mm

cureta
concha curva
lateral à direita
335mm

PH-39.3095



cureta
concha curva
lateral à esquerda
335mm

PH-39.3096



cureta vista
costas e frente



cureta vista
costas



7 dentes cortantes
curva 35°
R. 30mm
ø 8,5 mm

cureta
concha dentada
lateral à direita
335mm

PH-39.3085



cureta
concha dentada
lateral à esquerda
335mm

PH-39.3086



curva lateral
esquerda
9,5x18mm

Cureta Scoville extra longa
para ruptura de disco
curva lateral direita
335mm
PH-31.3350



curva lateral
direita
9,5x18mm

Cureta Scoville extra longa
para ruptura de disco
curva lateral esquerda
335mm
PH-31.3351



1/1



reta
5,0x7,5mm
PH-31.5370



ângulo reverso
5,0x7,5mm
PH-31.5375



angulada
5,0x7,5mm
PH-31.5380

Cureta Scoville
para ruptura de disco
254mm



230mm

PH-43.2345
Dissector reto
ponta curva
4,5mm

PH-43.2346
Dissector
em baioneta
curvo p/baixo
4,5mm

PH-43.2320
Dissector
em baioneta
curvo p/baixo
2mm

PH-43.2321
Impulsor
para
sutura

PH-43.2010
Micro dissector
reto ponta curva
1mm

210mm

PH-43.2011
Micro dissector
em baioneta
curvo p/ cima
1mm

PH-43.2012
Micro dissector
em baioneta
curvo p/ baixo
1mm







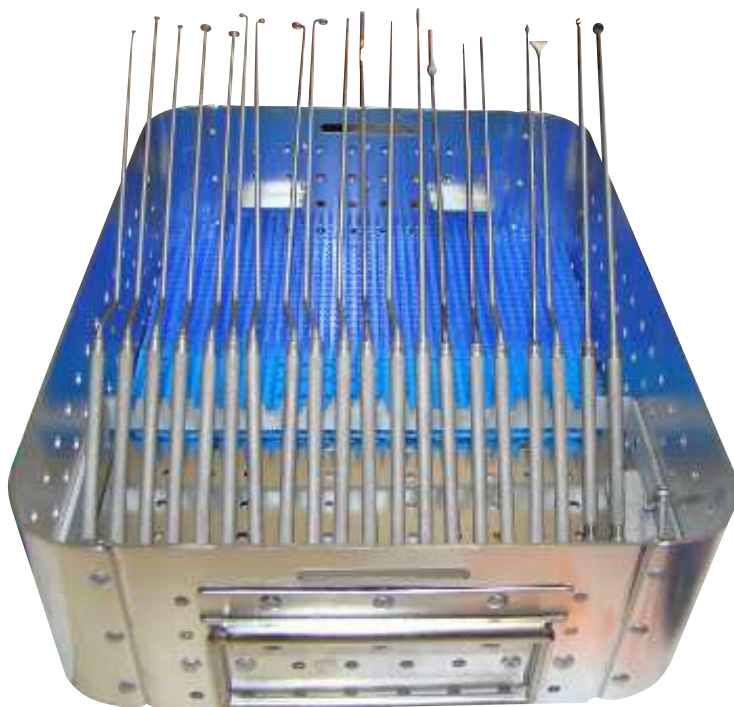



Somente estojo
PH-58.2499

Estojo completo contendo
20 instrumentos cirúrgicos
via endoscopia hipófise



Instrumentais para
cirurgia endoscópica
vide próximas páginas

- PH-14.0818 Micro cureta em baioneta 250,0mm ponta 90° para cima com corte
ø externo 3,0mm interno 2,5mm
- PH-14.0819 Micro cureta em baioneta 250mm ponta 45° para cima com corte
ø externo 3,0mm interno 2,5mm
- PH-14.0820 Cureta de aspiracao 250mm ponta 45° com fio redondo e corte
ø externo 5,0 interno 2,5mm
- PH-58.2516 Cureta de aspiracao 250mm ponta 45° com fio redondo e corte
ø externo 3,0 interno 2,5mm
- PH-58.2517 Micro cureta em baioneta com corte, ponta em ângulo lateral direito,
250mm ø Externo 3,0mm, Interno 2,5mm.
- PH-58.2518 Micro cureta em baioneta com corte, ponta em ângulo lateral esquerdo,
250mm ø Externo 3,0mm, Interno 2,5mm.
- PH-58.2519 Micro cureta em baioneta com corte, ponta em ângulo de 40°
250mm ø Externo 2,3mm, Interno 2,0mm.
- PH-58.2520 Micro cureta em baioneta com corte, ponta em ângulo de 90° p/ cima
250mm ø Externo 5,0mm, Interno 4,0mm.
- PH-58.2521 Micro cureta em baioneta com corte, ponta em ângulo lateral esquerdo,
250mm ø Externo 5,0mm, Interno 4,0mm.
- PH-58.2522 Micro cureta em baioneta com corte, ponta em ângulo lateral direito,
250mm ø Externo 5,0mm, Interno 4,0mm.
- PH-58.2523 Micro cureta em baioneta com corte, ponta em ângulo de 40°
250mm ø Externo 5,0mm, Interno 4,0mm.
- PH-58.2524 Micro espátula baioneta ponta reta 1,5mm | 250mm
- PH-58.2525 Medidor de ouvido em baioneta 250mm
- PH-58.2526 Micro dissector em baioneta ponta angulada 90° rombo 250mm
- PH-58.2527 Micro espátula em baioneta ponta curva para cima 1,5mm 250mm
- PH-58.2528 Micro bisturi em baioneta para ouvido 250mm
- PH-58.2529 Micro bisturi reto para ouvido 250mm
- PH-58.2530 Micro espátula ponta reta 1,5mm 250mm
- PH-58.2531 Micro espátula reta, ponta curva para cima 1,5mm, 250mm comprimento
- PH-25.2015 Cabo de bisturi 25,0cm

PH-58.2501	Cureta de aspiração com fio redondo e corte ø interior 5mm com ponta em ângulo 45° 250mm	
PH-58.2502	Cureta de aspiração com fio redondo e corte cego ø interior 7mm com ponta em ângulo 45° 250mm	
PH-58.2503	Cureta em forma de colher, redonda semi angulada ø 2mm 250mm	
PH-58.2504	Cureta com fio redondo e corte, ponta em ângulo de 90° 250mm ø Externo 7,0mm, Interno 6,0mm.	
PH-58.2505	Cureta com fio redondo e corte, ponta em ângulo de 45° 250mm ø externo 7,0mm, Interno 6,0mm.	
PH-58.2506	Cureta com fio redondo e corte, ponta em ângulo de 90° 250mm ø externo 5,0mm, Interno 4,0mm.	
PH-58.2507	Cureta com fio redondo e corte, ponta em ângulo de 45° 250mm ø externo 5,0mm, Interno 4,0mm.	
PH-58.2508	Cureta com fio redondo e corte, ponta em ângulo de 90° 250mm ø externo 4,0mm, Interno 3,0mm.	
PH-58.2509	Cureta com fio redondo e corte na face interna, ponta em ângulo de 45° 250mm ø externo 4,0mm, Interno 3,0mm.	

- PH-58.2510** Cureta com fio redondo e corte, ponta com ângulo de 90°
250mm ø externo 3mm, Interno 2,5mm
- PH-58.2511** Cureta com fio redondo e corte na face interna, ponta com ângulo de 45°
250mm ø externo 3mm, Interno 2,5mm
- PH-58.2512** Cureta 250mm ponta 90° com fio redondo sem corte
ø externo 3,0mm interno 2,5mm
- PH-58.2513** Cureta 250mm ponta 45° com fio redondo sem corte
ø externo 3mm, interno 2,5mm
- PH-58.2514** Cureta de aspiração com fio redondo sem corte, ponta com ângulo de 45°
250mm ø externo 7mm
- PH-58.2515** Cureta de aspiração 250mm ponta 45° com fio redondo sem corte
ø externo 5,0mm
- PH-58.2516** Cureta de aspiração 250mm ponta 45° com fio redondo sem corte
ø externo 3mm

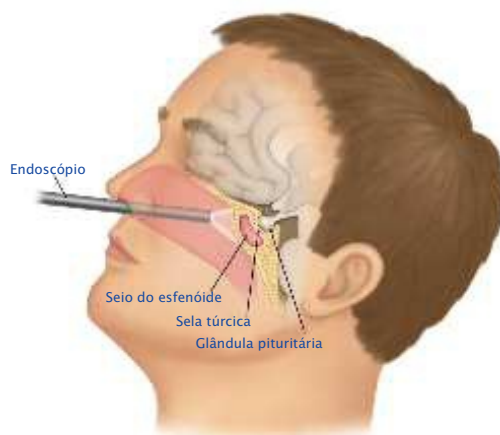

230mm



PH-21.2933

Dissector espátula redonda, afiado ponta
angulada 45° ø 3mm cabo recartilhado



PH-21.2934

Dissector espátula ligeiramente curvo, afiado
de 3mm, cabo recartilhado



PH-21.2935

Dissector espátula ligeiramente angulado inverso
afiado de 15°, tamanho 3mm, cabo recartilhado

190mm

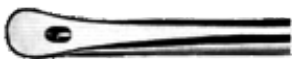

PH-21.2936

Dissector, aspirador modelo FREER, com sonda
de dilatação

190mm



PH-21.2937

Cureta de antro oval reta, longitudinal pequena



PH-21.2938

Cureta de antro oval angulada, longitudinal pequena

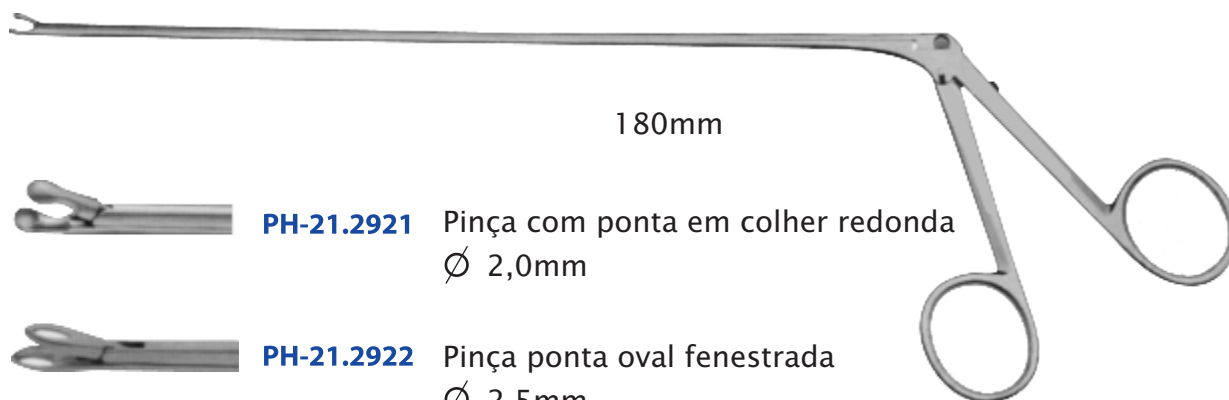

180mm



PH-21.2921 Pinça com ponta em colher redonda
Ø 2,0mm



PH-21.2922 Pinça ponta oval fenestrada
Ø 2,5mm

Micro-tesoura para acesso, corte duramater e procedimentos intradural

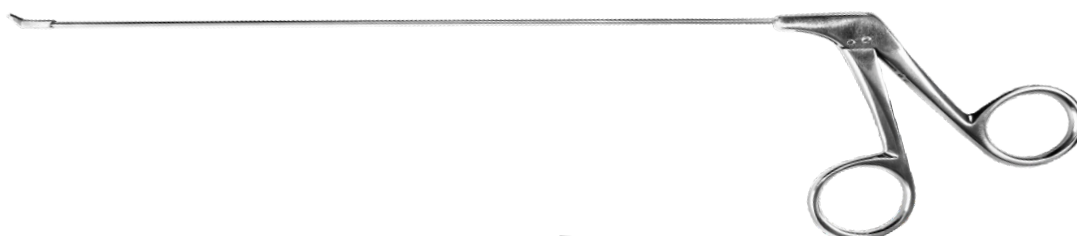

Micro-tesoura ponta reta
180mm
PH-21.2923



Micro-tesoura ponta curva
180mm
PH-21.2925



reta
PH-21.2927



angulada
PH-21.2928



Takahashi
120mm

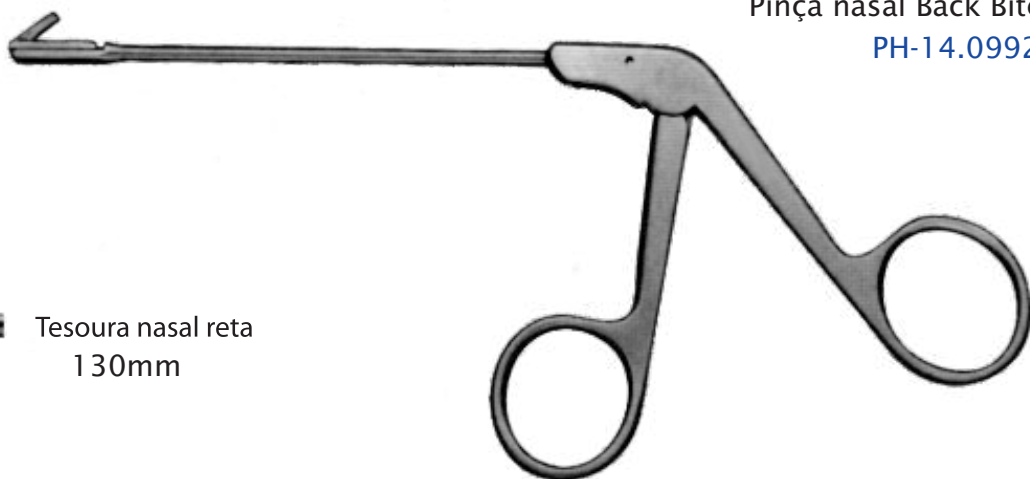

Pinça nasal Back Bite 130mm
PH-14.0992



PH-21.2929

Tesoura nasal reta
130mm



PH-21.2930

Pinça nasal afiada de corte seccional para corte liso sem danificar o tecido. Tipo Extra-suave, 45°, 130mm curva para cima tamanho 1,8 mm x 3mm



PH-21.2931

Pinça nasal afiada de corte seccional para corte liso sem danificar o tecido. Tipo Extra-suave, reta 130mm tamanho 1,8mm x 3mm



Weil-Blakesley
120mm



PH-21.2940 Pinça pequena reta com ponta oval fenestrada



PH-21.2941 Pinça pequena 45° com ponta oval fenestrada



PH-21.2942 Pinça pequena 90° com ponta oval fenestrada

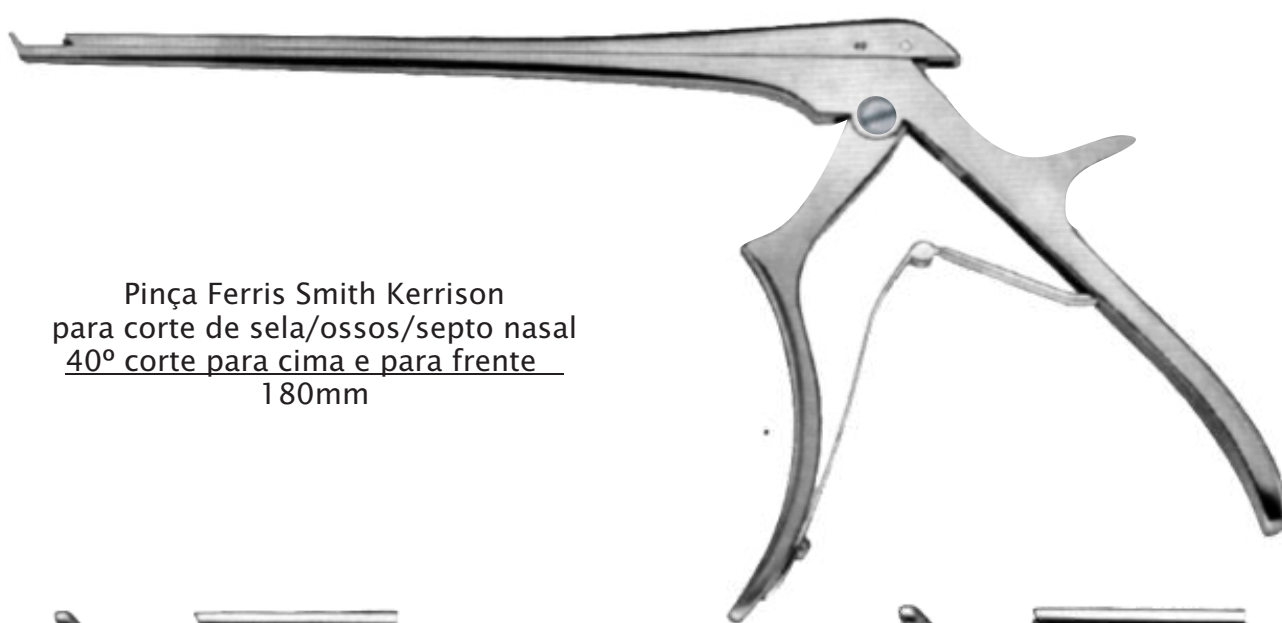

Pinça Ferris Smith Kerrison
para corte de sela/ossos/septo nasal
40° corte para cima e para frente
180mm



PH-46.1812 2mm



PH-46.1813 3mm

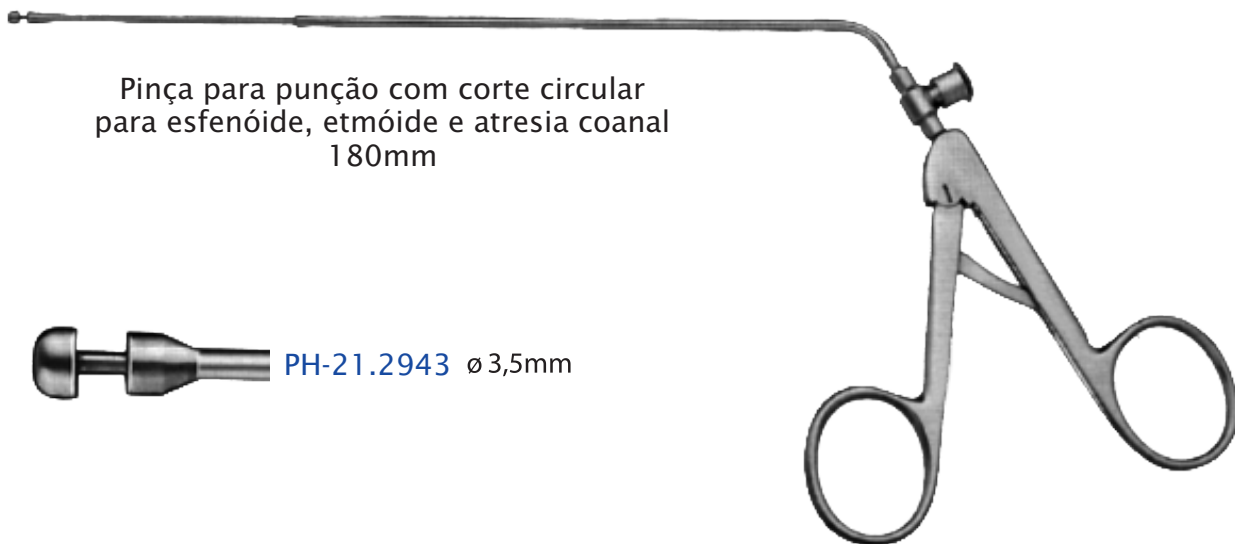

Pinça para punção com corte circular
para esfenóide, etmóide e atresia coanal
180mm

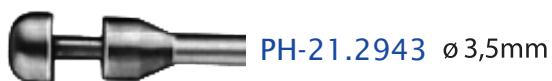

PH-21.2943 ø 3,5mm



PH-21.2944 ø 4,5mm



Pinça Goiva para
corte de sela / septo nasal
Middleton-Jansen

250mm
PH-37.3816



Pinça Goiva para
corte de sela / septo nasal
Middleton-Jansen

250mm
PH-37.3817

Microtesouras e Facas para Dissecção de Aderências e Cicatrizes



Micro Tesoura
180mm
PH-17.2231



Faca Caspar ponta cega/romba
200mm

reta
PH-17.2232

angulada
PH-17.2233

Micro Dissectores Cirurgia Base Cranial Fujita



185mm
PH-29.1851

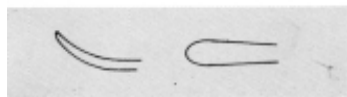

185mm
PH-29.1852



185mm
PH-29.1853

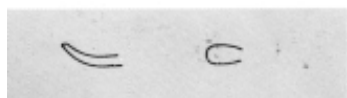

210mm
PH-29.2104

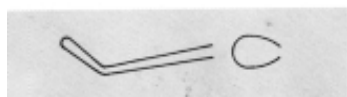

195mm
PH-29.1951

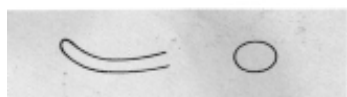

195mm
PH-29.1952

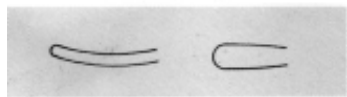

195mm
PH-29.1953



195mm
PH-29.1954



195mm
PH-29.1955

Ponta para Aspiração / Tubo de Sucção c/ Pressão Regulável e Intercambiável para Microcirurgia e Cirurgia Endoscópica



Ponta de aspirador fixo
PH-18.2270

Controle de regulagem deslizante manual



Ponta de aspirador intercambiável
(base para encaixe) 260mm
PH-18.2268

Entrada de ar para sucção

Especificações Técnicas:

- *Regulagem deslizante e Precisa
- *Design Anatômico
- *Delicado e Leve

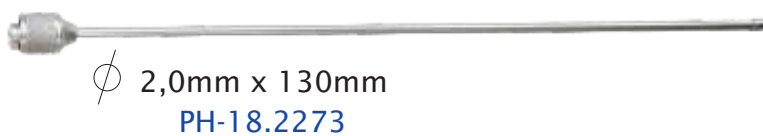

Ponteira com cureta em anel cortante ou cega para cirurgia endoscópica

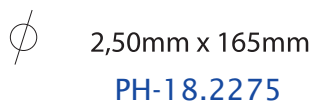

Conjunto completo
com 5 ponteiros
PH-18.2269



Ponta de aspiração Ferguson
angulada \varnothing 3,5
150mm
PH-18.2276

Ponta de aspiração Ferguson
angulada \varnothing 4,0
150mm
PH-18.2277



Ponta de aspiração
curvada para cima
extremidade atrumática
 \varnothing 2,5x130mm

PH-18.2278



Conjunto completo do suporte de cabeça neurocirúrgico Mayfield:

- 01 Braço de Leyla
- 01 Adaptador para afastador autostático Leyla
- 01 Suporte apoio de cabeça
- 01 Suporte para operar sentado
- 03 Pinos Infantil
- 03 Pinos Adulto

PH-10.1775





Pinos (Infantil)
PH-10.1769



Pinos (Adulto)
PH-10.1768

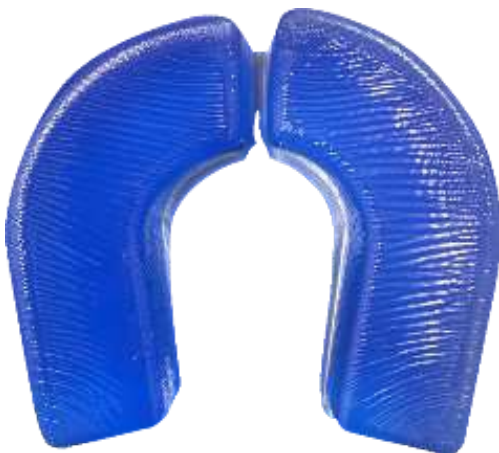

Suporte apoio de cabeça
(tipo ferradura regulável)
PH-10.1770



Suporte para
operar sentado
PH-10.1771

Pinça de Coagulação Bipolar

Scoville-Greenwood
PH-36.1-101-403



Cushing
PH-36.1-102-404



Gerald
PH-36.1-111-403



Gerald Irrigação
PH-36.1-110-320



Hardy
PH-36.1-121-436



Yasargil
fabricação sob encomenda



Referência	Descrição	Ponta Ouro (mm)	Comprimento
PH-36.1-101-403	Scoville-Greenwood	1.5	19.7cm
PH-36.1-102-404	Cushing	2.0	19.0cm
PH-36.1-111-403	Gerald	1.0	19.0cm
PH-36.1-110-320	Gerald Irrigação	1.0/1.8/4cm	
PH-36.1-121-436	Hardy	0.5	24.1cm
PH-36.1-159-405	Yasargil	0.5	15.9cm
PH-36.1-159-407	Yasargil	0.7	15.9cm
PH-36.1-159-410	Yasargil	1.0	15.9cm
PH-36.1-159-413	Yasargil	1.3	15.9cm

*Imagens meramente ilustrativas. Consulte disponibilidade de cores

Pinça de Coagulação Bipolar

Minimally 21.6cm
(escolher ponta)



Minimally 24.1cm
(escolher ponta)



Minimally 27.0cm
(ponta 0.7)



Gerald Bayonet
Irrigação
PH-36.1-320-10IR



Referência	Descrição	Ponta Ouro (mm)	Comprimento
PH-36.1-216-407	Minimally	0.7	21.6cm
PH-36.1-216-412	Minimally	1.2	21.6cm
PH-36.1-216-411	Minimally Ângulo 45°	0.7	21.6cm
PH-36.1-241-407	Minimally	0.7	24.1cm
PH-36.1-241-412	Minimally	1.2	24.1cm
PH-36.1-241-415	Minimally Ângulo 45°	0.7	24.1cm
PH-36.1-270-407	Minimally	0.7	27.0cm
PH-36.1-320-10 IR	Gerald Bayonet	1.018.4cm	

*Imagens meramente ilustrativas. Consulte disponibilidade de cores

Pinça de Coagulação Bipolar



Yasargil
Fabricação sob encomenda

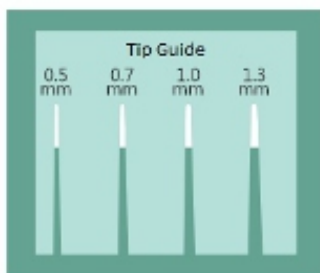

Referência	Descrição	Ponta Ouro (mm)	Comprimento
PH-36.1-181-405	Yasargil	0.5	18.1 cm
PH-36.1-181-407	Yasargil	0.7	18.1 cm
PH-36.1-181-410	Yasargil	1.0	18.1 cm
PH-36.1-181-413	Yasargil	1.3	18.1 cm

Referência	Descrição	Ponta Ouro (mm)	Comprimento
PH-36.1-200-405	Yasargil	0.5	20.0cm
PH-36.1-200-407	Yasargil	0.7	20.0cm
PH-36.1-200-410	Yasargil	1.0	20.0cm
PH-36.1-200-413	Yasargil	1.3	20.0cm

*Imagens meramente ilustrativas. Consulte disponibilidade de cores

Pinça de Coagulação Bipolar

Gerald 18.4cm
(escolher ponta)
PH-36.3-110-320



Jansen 15.2cm
(escolher ponta)



Jansen 17.8cm
(escolher ponta)



Jansen 20.4cm
(escolher ponta)



Malis 17.8cm
(escolher ponta)



Scoville Greenwood
(escolher ponta)
PH-36.1-110-430



*Imagens meramente ilustrativas. Consulte disponibilidade de cores

Pinça de Coagulação Bipolar

Yasargil

(escolher ponta)

PH-36.1-110-440



Hardy

(escolher ponta)

PH-36.1-110-460



Hardy angulada

PH-36.1-110.470

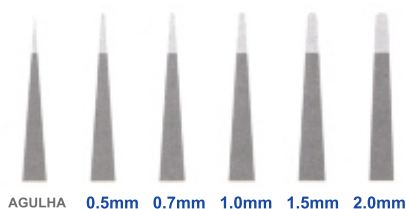

Referência	Descrição	Ponta (mm)	Comprimento
PH-36.3-110-320	Gerald	1.0-1.5-2.0	18.4cm
PH-36.3-152-005	Jansen	05	15.2cm
PH-36.3-152-010	Jansen	1.0	15.2cm
PH-36.3-152-015	Jansen	1.5	15.2cm
PH-36.3-178-005	Jansen	05	17.8cm
PH-36.1-110-360	Jansen	0.5-1.0-1.5	17.8cm
PH-36.3-178-015	Jansen	1.5	17.8cm
PH-36.3-204-005	Jansen	0.5	20.4cm
PH-36.3-204-010	Jansen	1.0	20.4cm
PH-36.3-204-015	Jansen	1.5	20.4cm
PH-36.3-178-010	Malis	1.0	17.8cm
PH-36.1-110-400	Malis	0.5-1.0-1.5-2.0	17.8cm
PH-36.3-178-020	Malis	2.0	17.8cm
PH-36.1-110-430	Scoville Greenwood	05-1.0-2.0	19.1cm
PH-36.1-110-440	Yasargil	1.0-1.5	19.7cm
PH-36.1-110-460	Hardy	1.0	21.6cm
PH-36.1-110.470	Hardy Ang.	1.0	21.6cm

*Imagens meramente ilustrativas. Consulte disponibilidade de cores

Pinça de Coagulação Bipolar com Irrigação

Hardy Bayonet
(escolher ponta)
PH-36.3-110-460 IR



Jansen Bayonet
(escolher ponta)
PH-36.3-110-370 IR



Scoville Greenwood
(escolher ponta)
PH-36.3-110-430 IR



Gerald Bayonet
(escolher ponta)
PH-36.3-110-320 IR

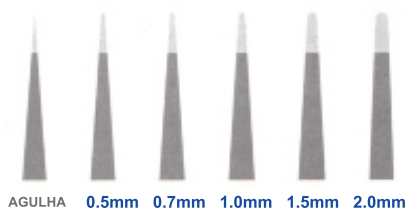

Referência	Descrição	Ponta (mm)	Comprimento
PH-36.3-110.460IR	Hardy	1.0-1.5	21.6cm
PH-36.3-110.470IR	Hardy	1.0	21.6cm
PH-36.3-110.370IR	Jansen	1.0-1.5	19.1cm
PH-36.3-110.430IR	Scoville Greenwood	1.0-1.5	19.7cm
PH-36.3-110.320IR	Gerald	1.0-1.5-2.0	18.4cm

*Imagens meramente ilustrativas. Consulte disponibilidade de cores

Gerald Bayonet
(escolher ponta)
PH-36.2-110.320 NS



Jansen Bayonet
(escolher ponta)
PH-36.2-110.360 NS



Scoville-Greenwood
(escolher ponta)
PH-36.2-110.430 NS



Yasargil
(escolher ponta)
PH-36.1-121-440 NS



Hardy Bayonet
(escolher ponta)
PH-36.1-201-460 NS



Referência	Descrição	Ponta (mm)	Comprimento
PH-36.2-110.320NS	Gerald	0.5-0.7-1.0-1.5-2.0	17.8cm
PH-36.2-110.360NS	Jansen	0.5-0.7-1.0-1.5-2.0	17.8cm
PH-36.2-110.430NS	Scoville-Greenwood	0.5-0.7-1.0-1.5-2.0	19.1cm
PH-36.2-110.440NS	Yasargil	0.5-0.7-1.0-1.5-2.0	19.7cm
PH-36.2-110.460NS	Hardy	0.5-0.7-1.0-1.5-2.0	19.7cm

*Imagens meramente ilustrativas. Consulte disponibilidade de cores

Pinça de Coagulação Bipolar

Bayoneta



Bayoneta



Bayoneta Angulada

(ANG. P/ CIMA)
(ANGLED UP)
(ANG. ARRIBA)



Bayoneta Angulada

(ANG. P/ BAIXO)
(ANGLED DOWN)
(ANG. BAJA)



Referência	Descrição	Ponta (mm)	Comprimento
PH-36.4-140.005	Bayoneta	0.5	14.0cm
PH-36.4-140.010	Bayoneta	1.0	14.0cm
PH-36.4-140.020	Bayoneta	2.0	14.0cm
PH-36.4-610.170	Bayoneta	0.5-0.7-1-0-2.0	18.0cm
PH-36.4-610.180	Bayoneta	0.5-1-0-2.0	20.0cm
PH-36.4-610.190	Bayoneta	0.5-0.7-1-0-2.0	22.0cm
PH-36.4-200.005	Bayoneta p/ cima	0.5	20.0cm
PH-36.4-200.010	Bayoneta p/ cima	1.0	20.0cm
PH-36.4-200.020	Bayoneta p/ cima	2.0	20.0cm
PH-36.4-610.192	Bayoneta p/ cima	0.5-1-0-2.0	22.0cm
PH-36.4-610.185	Bayoneta p/ baixo	0.5-1-0-2.0	20.0cm
PH-36.4-610.195	Bayoneta p/ baixo	0.5-1-0-2.0	22.0cm

*Imagens meramente ilustrativas. Consulte disponibilidade de cores

Cabo para Pinça Bipolar Siliconizado



Cabo de silicone bipolar modelo americano redondo 3,0m
[PH-36.5-190-100](#)

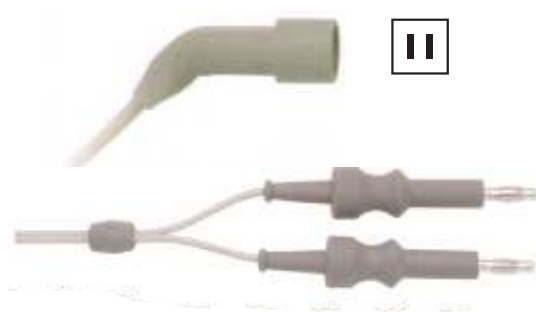

Cabo de silicone bipolar modelo europeu 3,0m
[PH-36.5-190-170](#)

A

ACRA-CUT Broca	57
ADSON Afastador	13
ADSON BABY Afastador	14
ADSON Descoladores/Elevadores Periosteó	87
ADSON Gancho	98
ADSON Pinça Protetora de Duramater	06
ADSON Pinça para Tumor	131
ADSON Pinça Micro-Cirúrgica	129
ADSON BROWN Pinça Micro-Cirúrgica	129
ADSON Pinça Goiva	101,109
ADSON Ponta de Aspirador/Cânula	62
AFASTADOR/DESCOLADOR	60
AFASTADOR Coluna Lombar	36
ALICATE / CORTADOR C/ WÍDIA	08,09,10
ALM Afastador	19
ANDERSON ADSON Afastador	14
ARMY NAVES/CLOWARD Afastador	26
ASPIRADOR /AFASTADOR	59,60,61,62
ASPIRADOR Ponta Fixa Regulável	166
ASPIRADOR Ponta Regulável e Intercambiável	166

B

BACON Pinça Goiva	101
BALLENGER Faca Giratória	97
BALLENGER Cinzel	68
BECKMANN Afastador	11,12
BECKMANN ADSON Afastador	11,33
BECKMANN EATON Afastador	11
BERNARDÃO Alicate	08
BERGMANN Martelo	110
BEYER Pinça Goiva	107
BIPOLAR Pinça De Coagulação	171,172,173,174,175,176,177,178
BIPOLAR Pinça De Coagulação Intercambiável	179,180
BIPOLAR Cabo	181
BIPOLAR Pinça Descartável	170
BOHLER Pinça Goiva	104
BROCA Rocha Regulável	57
BUSHE Cureta	71

C

CABO P/ BISTURI N° 3	63
CABO P/ BISTURI N° 4	63
CABO P/ BISTURI N° 7	64
Cadeira para Neurocirurgia	149
CASPAR Afastador/Retrator	16,37,46,47
CASPAR COUNTER Afastador/Retrator	38
CASPAR Chassi Distrator Vertebral Esquerdo/Direito (Afastador)	49,50
CASPAR Chassi Distrator c/ Guia De Broca	50
CASPAR Colocador de Enxerto	52
CASPAR Cureta	69,78
CASPAR Dissector/Impulsor/Micro Dissector	153
CASPAR Dissector Corpo Vertebral	52
CASPAR Espéculo	53,54

Índice



Pró-Hospitalar
Equipamentos Médicos Ltda

CASPAR Guia de Parafuso	49,50
CASPAR Guia de Broca Esquerdo/Direto	49,50
CASPAR Impactador de Enxerto Kit	52
CASPAR Parafuso Fixador	49,50
CASPAR Distrator Cervical Kit	51
CLOWARD Afastador	26,47,48
CLOWARD Cinzel/Osteótomo	67
CLOWARD Pinça p/ hernia de disco	134,135,136,137,138,139
COTTLE Cinzel/Descolador/Elevador Septo	68,91
COTTLE Espéculo	95
COLÔNIA Clips Metálico	06
COBB Descolador/Elevador/Osteótomo	80,81
CONE Afastador	11
COHEN Descolador/Elevador	147
COLLIN Martelo	111
COXIM p/ cirurgia de coluna	150
CRILE Gancho p/ nervos	99
CRUTCHFIELD Trator/Pontas	109
CUSHING Afastador	26
CUSHING Broca	57
CUSHING Descolador/Elevador/Rugina	87,88
CUSHING Espéculo	96
CUSHING Gancho p/ nervos	98,99
CUSHING Pinça Micro-Cirúrgica	130
CUSHING Pinça p/ hernia de disco	134,135,136,137,138,139
CUSHING Rugina	147
CURETAS ESPECIAIS Conha via lateral	74,76,77
CURETAS ESPECIAIS Tóraco/Lombar	152,153

D

DALE Pinça Goiva	106
DANDY Pinça p/ couro cabeludo	06
DANDY Ganchos p/ nervos	98
DAVIS Afastador	26
DAVIS Descolador/Dissectores	89
D'ERRICO Trefina	58
DEGREE Micro Tesoura Vasculare	124
DESCOLADOR Afastador p/ Duramater Coluna	90
DOWNING Afastador	133

E

ECLHIN Pinça Goiva	102
EJETOR Lâminas	22,33,55
ELEVADOR Periosteal	85,92
EPSTEIN Cureta	73
ESPÁTULAS Maleavéis	97
ESPÉCULO Afastador/Retrator	39
ESPÉCULO Mathieu Trivalve	94
ESPÉCULO Nasal Delicado Acesso Endoscópico	96
ESPÉCULO Nasal Delicado	95
ESTOJO p/ Instrumentos cirúrgicos Rothon/Hipófise	113
ESTOJO Avulso	114

Índice



Pró-Hospitalar
Equipamentos Médicos Ltda

F

FARABEUF Afastador	29
FERRIS SMITH Pinça Kerrison p/ Hipófise	143
FERRIS SMITH Pinça Love	132
FERGUSON Pontas de Aspiração p/ Hipófise	167
FRAIZER Descolador/Dissectores/Elevadores	91
FRAIZER Cânula Ventricular/Graduada	62
FRAIZER Ponta de Aspirador/Tubo de Sucção	59,60,61
FRAIZER Ganchos p/ nervos	99
FRAIZER Tesoura Neuro Cirúrgica	146
FRANÇOIS Descolador	92
FREER Cinzel/Descolador/Elevador Septo	68,89
FRYKHOLM Pinça Goiva	106
FUJITA Descolador/Elevador	146
FUJITA Micro Dissectores Cirurgia Base Cranial	165
FULTON Pinça Goiva	107

G

GANCHOS Sonda	99
GANCHOS c/ Mola	07
GARDNER-WELLS Trator	109
GELPI Afastador	17,20,21,22
GELPI-SEILETZ Afastador	17
GERALD Pinça Micro-Cirúrgica	130
GIGLI Cabo/Condutor/Guia	79
GIGLI Serra em aço inox	79
GIL-VERNET Afastador	27
GILLIES Ganchos p/ nervos	99
GLASER Afastador Fixo/Articulado	24
GRAHAM Ganchos p/ nervos	98

H

HAJEK Martelo	111
HALLE Cureta	71
HALLO VEST p/ Imobilização Cervical	151
Hardy Pinça Bipolar	175
HIBBS Afastador	29
HIBBIS Cinzel Goivas	66
HIPÓFISE Ponta de Aspiração	167
HIPÓFISE Curetas	157,158,159
HIPÓFISE Aspirador/Dissector/Espátula/Microdissector	156,159
HIPÓFISE Pinças	160,161,162,163
HIPÓFISE Microtesoura/Tesoura	160,161,164
HIPÓFISE Faca p/ Dissecção	164
HOEN Descolador/Dissector/Elevador	91
HOEN Ganchos p/ nervos	98
HOEN Pinça p/ hernia de disco	133
HOHMANN Afastador/Retrator	30
HOKE Cinzel/Osteótomos	67
HOLSCHER Afastador	26
HORSLEY Descolador/Dissector/Elevador	93
HUDSON Broca	57
HUDSON Trépano Manual	58
HUDSON Extensão Cerebelar	57
HUNT YASARGIL Pinça p/ tumor	126

Índice



Pró-Hospitalar
Equipamentos Médicos Ltda

I

INDIAN Pinça Goiva	105
INGE Afastador/Retrator	48

J

JACOBSON Micro Porta Agulha	115
JACOBSON Micro Tesoura	121
JANETTA Afastador/Retrator	40
JANSEN MASTOIDE Afastador/Retrator	19
JANSEN SCALP Afastador/Retrator	19
JANSEN Pinça Baioneta para tumor	131
JANSEN Pinça Goiva	103
JANSEN GRUENWALD Pinça Micro-Cirúrgica	130

K

KARLIN Descolador/Elevadores	86
KERRISON Pinça p/ Laminectomia	142,143,144
KERRISON BLACK Pinça p/ Laminectomia	145
KERRISON ANGULADA Pinça p/ Laminectomia	145
KILLIAN Cinzel/Osteótomo	68
KILLIAN CLAUS Cinzel/Osteótomo	67,68
KILLIAN Espéculo	95
KIT Completo Instrumentais Cirúrgicos (hipófise)	155
KIT Osteotomia Cervical / Lombar	112
KNIGHTON Afastador/Retrator	23
KLEINERT-KUTZ Pinça Goiva	108
KOROS Afastador/Retrator	38

L

LAHEY Ganchos p/ nervos	99
LÂMINAS (Cegas, Dissectomia, Fenestrada, Laterais, Longitudinal, Magana, Medial, Scoville).	22,33,38,39,47,55
LAMBOTTE Cinzel/Osteótomo	65
LAMBOTTE Rugina	147
LANGENBECK Afastador/Retrator	31,32
LANGENBECK Descolador/Elevador/Rugina	147,27
LANGENBECK GREEN Afastador/Retrator	64
LATERAL Cabo p/ Bisturi	128
LAZAR Pinça Micro-Cirúrgicas	106
LEKSELL Pinça Goiva	91
LEMPERT Cinzel/Elevador Septo	103
LEMPERT Pinça Goiva	65
LEXER Cinzel/Osteótomo	82,83,84,85
LEXER Descolador/elevador	41,42,43,44,45
LEYLA Afastador/Retrator	100
LISTON KEY (HORSLEY) Cizalha	100
LISTON Cizalha	25,46
LOVE Afastador/Retrator	91
LOVE ADSON Descolador/Dissector/Elevador	134,135,136,137,138,139
LOVE GRUENWALD Pinça p/ hernia de disco	130
LUCAE Pinça Microcirúrgica	110
LUCAE Martelo	103
LUER Pinça Goiva	

Índice



Pró-Hospitalar
Equipamentos Médicos Ltda

M

MAGANA Afastador/Retrator	37
MALIS Elevador	147
MALIS Ganchos p/ nervos	98
MALLIS Micro Tesoura	116
MALIS Pinça Bipolar	175
MACKENZIE Broca	57
MARKHAM MEYERDING Afastador/Retrator	17
MARQUARDT Pinça Goiva	107
MARTELO	110,111
MAYFIELD Pinça Goiva	108
MAYFIELD Pinos Adulto/Infantil	169
MAYFIELD Suporte Apoio de Cabeça	169
MAYFIELD Suporte p/ Operar Sentado	169
MAYFIELD Suporte de Cabeça Neurocirúrgico	168
MEAD Martelo	111
METZENBAUM Tesoura Neuro Cirúrgica	146
MEYERDING Afastador/Retrator	19,29
MICHAEL Agrafes	06
MIDDLETON JANSEN Pinça Goiva p/ Hipófise	163
MILLIGAN Descolador/Dissector/Elevadores	90

O

OLDBERG Pinça p/ hernia de disco	132
OLIVERCRONA Descolador/Dissector/Elevadores	90
OLIVERCRONA Pinça Goiva	103

P

PARTSCH Martelo	110
PASSADOR Cateter	141
PENFIELD'S Descolador/Dissectores/Elevadores	93
POPPEL GELPI Afastador/Retrator	17
PORTA AGULHA p/ Suturas Delicadas (Crânio/Cervical/Lombar)	115
POTTS-SMITH Pinça Micro-Cirúrgica	130
POTTS-SMITH Micro Tesoura	122
PROF. GUSMÃO Descolador/Dissector	91
PRESBYTERIAN Descolador/Elevador	147

R

RAIZES NERVOSAS Afastador	25,26,27,46
RANEY Aplicador de Clip	06
RANEY Clips Descartável/Metálico	06
ROCHA Broca	57
RHOTON Micro Dissectores	113,114
ROTTGEN RUSKIN Pinça Goiva	108
RUSKIN Pinça Goiva	104
RUSKIN LISTON Pinça Goiva	106

Índice



Pró-Hospitalar
Equipamentos Médicos Ltda

S

SACHS Descolador/Dissectores/Elevadores	92
SCHLESINGER Pinça p/ hérnia de disco	134,135,136,137,138,139
SCOVILLE HAVERFIELD Afastador/Retrator	35
SCOVILLE Afastador/Retrator	25,34
SCOVILLE Cureta Especiais	153
SCOVILLE Ganchos	35
SCOVILLE Lâminas	35
SEMB Cizalha/Pinça Goiva	100,102
SEMKEN Pinça Micro-Cirúrgica	129
SENN GREEN Afastador/Retrator	27
SENN MULLER Afastador/Retrator	27
SENN MULLER BABY Afastador/Retrator	27
SICARD Pinça Goiva	104
SIMON Cureta	70
SCHNITMAN JANSEN Afastador/Retrator	19
SMITH PETERSEN Pinça Goiva	107
SMITH PETERSEN Cinzel/Osteótomos	67
SOFIELD Afastador/Retrator	56
SPINAL Cureta	73,74,75,76,77
SPINAL Osteótomo	85
SPURLING Pinça p/ hernia de disco	134,135,136,137,138,139
STILLE Cinzel/Osteótomo	66
STILLE Pinça Goiva	102
STILLE LISTON Cizalha	100
STILLE LUER Pinça Goiva	102
STILLE RUSKIN Pinça Goiva	106
STRULLY Tesoura Neuro Cirúrgica	146
STRULLY Cabo de Serra de Gigli	79

T

TAKAHASHI Pinça p/ Hipófise	106
TAYLOR Afastador/Retrator	28,29
TAYLOR Tesoura Neuro Cirúrgica	145
TAYLOR Pinça Micro-Cirúrgica	130
TONNIS Descolador/Dissector/Elevador	93
TREFINA de Biópsia	148
TROCATER	148
TWIST DRILL Broca Caspar	49,50
TWIST DRILL	58

V

VALIN Afastador/Retrator	33
VANNAS Micro Tesoura	123
VASCULAR Micro Tesoura	124
VERTICAL Cabo p/ Bisturi	64
VOLKMANN Cureta	72

Índice



Pró-Hospitalar
Equipamentos Médicos Ltda

W

WEITLANER Afastador	14,15,16
WEIL-BLAKESLEY Pinça p/ Hipófise	162
WILDE Pinça p/ Tumor	131
WILDE Pinça p/ Hérnia de Disco	133
WILLIAMS Afastador/Retrator	18
WILLIAMS Ponta de Aspirador/Retrator	62
WILLINGER Cureta	75
WOODSON Descolador/Dissectores/Elevadores	89

Y

YASARGIL Descolador/Dissectores/Cinzel/Elevador	89
YASARGIL Micro Tesoura/Tesoura	117,118,119,120,123
YASARGIL Pinça Dissecção Micro-Cirúrgica/Tumores	125,127
YASARGIL Pinça Bipolar	175
YASARGIL SAMII Pinça Dissecção/Tumor	126

Z

ZAUFAL JANSEN Pinça Goiva	108
---------------------------	-----

Rua Severino Lara, 09 - CEP 31610-260 - Belo Horizonte / MG / Brasil
*55 (31) 3071-6200 / prohospitalar@prohospitalar.com.br
sac@prohospitalar.com.br
www.prohospitalar.com.br